

# Testing Solutions for Protection and Measurement Systems

Product Catalog



## **The Company**

---

OMICRON is an international company serving the electrical power industry with leading testing solutions. The application of OMICRON products allows users in more than 140 countries to test their protection, measurement, and primary equipment with complete confidence.

### **Continuous Innovation**

For more than 20 years, innovations from OMICRON have set new standards in secondary testing. The CMC test equipment led the way with many advances such as the first use of the vector diagram, the first IEC 61850 implementation and many more, while RIO, the Relay Interface of OMICRON, and its successor, XRIO, established yet another industry standard. With the patented OMICRON Control Center technology, automated testing of protective relays was revolutionized.

### **Excellent Knowledge Base**

OMICRON's engineers understand the needs of its customers and continue to develop solutions for the world's power systems. Regular user meetings provide platforms for the exchange of information and experiences. OMICRON shares this expertise through its membership of many international standardization bodies. The provision of extensive expert knowledge and worldwide application oriented training helps customers to achieve cost effective testing and commissioning.

### **First Class Quality**

Customers rely on the company's ability to provide products of the highest quality which OMICRON is constantly striving to achieve. The commitment and unique spirit of a team of excellent employees is the company's greatest asset. Winning the "Great Place to Work" award represents international recognition of the standards it attains in its working environment.

### **Extraordinary Customer Support**

With an international sales and support network of company offices, distributors and representatives around the world, OMICRON is always accessible to its customers for individual attention. Extraordinary customer support and long term customer relationships ensure trust and successful co-operation.

<b>Test Set Overview</b> .....	4	<b>RelaySimTest</b> .....	36
<b>CMControl</b> .....	6	<b>RelayLabTest</b> .....	37
<b>Test Universe</b> .....	7	<b>CMC Test Sets</b>	
<b>Software / Modules</b>		CMC 356.....	38
QuickCMC .....	10	CMC 256plus.....	41
State Sequencer .....	11	CMC 353.....	44
Ramping .....	12	CMC 310.....	47
TransPlay.....	12	CMC 850.....	49
Harmonics.....	12	CMControl .....	50
Binary I/O Monitor .....	13	<b>Accessories</b>	
CB Simulation.....	13	CMGPS 588 Synchronization Unit.....	51
Pulse Ramping.....	13	CMIRIG-B Interface .....	52
Overcurrent .....	14	SEM Scanning Equipment for Meters .....	53
Overcurrent Characteristics Grabber .....	14	SER Scanning Equipment for Relays.....	53
Distance .....	15	CMLIB A Low Level Signal Connector .....	54
Differential.....	15	Cable Connector for REF 54x.....	54
Autoreclosure .....	15	CMLIB REF6xx Interface Adapter.....	54
Advanced Distance.....	16	CMLIB 7Sx8 Interface Adapter .....	54
VI Starting .....	17	RIB1 Low Level Isolation Box .....	54
Advanced Differential.....	18	RXB1 Binary Output Extension.....	54
Annunciation Checker.....	19	CPOL Polarity Checker .....	55
Synchronizer.....	20	C-Probe 1 Current Clamp.....	55
Transient Ground Fault.....	20	C-Shunt.....	55
Advanced TransPlay .....	21	CMTAC 1 AC to DC Trigger Rectifier .....	55
Meter.....	22	ARC 256x Arc Flash Initiator .....	55
Transducer .....	23	100TX to 100FX-SC Converter.....	56
OMICRON Control Center .....	24	PoE Injector.....	56
Pause Module, Text View, ExeCute .....	24	CMUSB-P USB to Parallel Converter.....	56
Test Object Definition with XRIO.....	25	Generator Combination Cable.....	56
PTL Protection Testing Library .....	25	CMC Wiring Accessory Package .....	56
CM Engine Programming Interface .....	26	Standard Test Set Accessories .....	57
FCS Field Calibration Software.....	26	Transport Cases .....	58
<b>Additional Software</b>		Foldable Stand.....	58
PQ Signal Generator .....	27	Recloser and Sectionalizer Control Test Cables .....	59
NetSim .....	28	<b>ISIO 200</b> .....	60
EnerLyzer.....	29	<b>DANEO 400</b> .....	61
TransView.....	31	<b>ADMO</b> .....	62
<b>IEC 61850 Testing Tools</b>		<b>OMICRON Worldwide</b> .....	63
IEDScout .....	32		
GOOSE .....	33		
Sampled Values (SV) .....	33		
IEC 61850 Package.....	33		
SVScout.....	34		
CMC 850 Package .....	35		

# Test Set Overview

## CMC Test Sets



OMICRON's commitment to innovation is evident in the outstanding features and the quality of its test equipment. Making use of leading-edge technology in both development and quality assurance, OMICRON sets new standards for advanced testing equipment in terms of flexibility, accuracy, portability and reliability.

Depending on the requirements, users can choose between several unique devices with different operation options from the CMC test set family:<sup>1</sup>



- 6 x 32 A / 430 VA
- 3 x 64 A / 860 VA
- 1 x 128 A / 1000 VA
- 4 x 300 V

### CMC 356

#### 6 Phase Current + 4 Phase Voltage Test Set and Commissioning Tool

The CMC 356 is the universal solution for testing all generations and types of protection relays. Its powerful six current sources (three-phase mode: up to 64 A / 860 VA per channel) with a great dynamic range, make the unit capable of testing even high-burden electromechanical relays with very high power demands. Commissioning engineers will particularly appreciate its ability to perform wiring and plausibility checks of current transformers, by using primary injection of high currents from the test set. The CMC 356 is the first choice for applications requiring the highest versatility, amplitude and power.

**Operation:** PC or CMControl



- 6 x 12.5 A / 80 VA
- 3 x 25 A / 160 VA
- 4 x 300 V
- Error < 0.015 % (rd.) + 0.005 % (rg.) typ.

### CMC 256plus

#### 6 Phase Current + 4 Phase Voltage Test Set and Universal Calibrator

The CMC 256plus is the first choice for applications requiring very high accuracy. This unit is not only an excellent test set for protection devices of all kinds but also a universal calibration tool. Its high precision allows the calibration of a wide range of measuring devices, including: energy meters of class 0.2S, measuring transducers, power quality measurement devices and phasor measurement units (PMU). Its unique accuracy and flexibility make the CMC 256plus ideal for protection and measurement equipment manufacturers for research and development, production and type testing.

**Operation:** PC or CMControl



- 3 x 32 A / 430 VA
- 1 x 64 A / 860 VA
- 4 x 300 V

### CMC 353

#### 3 Phase Current + 4 Phase Voltage Test Set and Commissioning Tool

With its compact design and low weight of 13.3 kg (29.3 lbs), the CMC 353 provides the perfect combination of portability and power. It is the ideal test set for three-phase protection testing and the commissioning of SCADA systems. The powerful current outputs (3 x 32 A / 430 VA) support 5 A relay testing in an optimal way. The portable design makes this device an excellent choice for commissioning and maintenance tasks, particularly in industry, distributed generation, and medium and low voltage applications. It meets a wide variety of challenges in protection engineering – from testing electromechanical relays to the latest IEC 61850 IEDs.

**Operation:** PC or CMControl

<sup>1</sup> Detailed technical specifications and ordering information see pages 38–49



- 3 x 15 A / 350 VA
- 1 x 30 A / 500 VA
- 3 x 300 V

### CMC 310

#### 3 Phase Current + 3 Phase Voltage Test Set

The CMC 310 is specifically designed for manual three-phase testing of protection and measurement devices. The lightweight and compact design makes the CMC 310 particularly suitable for testing distribution and industrial systems.

**Operation:** CMControl



### CMC 850

#### IEC 61850 Test Set

The CMC 850 is OMICRON's protection test set dedicated to IEC 61850. It focuses on the real-time communication methods of GOOSE and Sampled Values to interface with the devices under test. The test set is controlled by the proven Test Universe software. Beyond this, the CMC 850 offers several embedded functions, which are accessible through a Web interface by simply using an ordinary Web browser. Since time synchronization is often required in such test cases, the CMIRIG-B is supplied along with the CMC 850. The unit is small and lightweight because its focus on IEC 61850 applications means there is no need for conventional binary I/Os and amplifiers for the secondary signals.

**Operation:** PC



### Amplifiers CMA 156 + CMS 156

#### 6 Phase Current Amplifier + 3 Phase Voltage and Current Amplifier

CMA 156 and CMS 156 amplifier units can be used in combination with CMC test sets or in conjunction with digital real time power system network simulators.

For more information please visit our website.

## Signal Analyzer



### DANE0 400

#### Distributed Hybrid Signal Analyzer for Power Utility Automation Systems

DANE0 400 (see page 61) is a hybrid measurement system that records and analyzes all conventional signals (voltages, currents, hard wired binary status signals) and messages on the communication network in a substation. It measures signals from both of these worlds and can provide information to assess their proper coordination. The device keeps track of what is going on in the substation by obtaining information on the operational status and communication.

**Operation:** DANE0 Control Software or web interface

# CMControl



CMC Test Set with CMControl

The CMControl is a front panel control device for use with the CMC 356, CMC 256plus, CMC 353, CMC 310, and CMC 256-6 test sets.<sup>1</sup> Used as an alternative to the powerful PC-based Test Universe software, its instant availability and easy operation make it ideal for the quick verification of test objects. With the intuitive touch screen user interface setting up tests is particularly easy and convenient. The control wheel also makes the adjustment of output quantities very efficient.

Depending on the preferred working position, the CMControl can either be attached to the CMC test set as a front panel control unit or be detached and used as a handheld control device. Magnetic elements at the rear allow it to be easily attached to standard protection cubicles.

The CMControl supports the following applications:

- > Testing of protection and measurement devices (version P)
- > Testing of recloser and sectionalizer controls (version R)



The two versions differ in the software running on the CMControl. It is possible to cover both applications with the same device by ordering both versions in combination or by upgrading at a later stage.

## CMControl P

The CMControl P is specifically designed for testing protection and measurement equipment with CMC test sets. The test tools included and the integrated fault models are optimized for manual testing to get reliable test results very quickly.

The CMControl P test tools provide a wide range of functions:

- > In "Direct" mode all of the test set's outputs can be controlled individually
- > "Wiring Check" is used to verify the wiring between the test set and the device under test and supports the use of the CPOL polarity checker
- > "Pick Up/Drop Off" allows thresholds of protective relays to be checked
- > Trip times or other timings of a protective relay can be verified with the "Time" tool
- > "Time Characteristics" is designed to test relays with multiple timing stages or particular characteristics
- > With the "Reclosure" tool the number of cycles and cycle times of a reclosure function can be checked
- > The "Meter" test tool is used to calibrate electricity meters and to perform start-up and no-load tests
- > The "Transducer" test tool is used to verify and automatically assess the accuracy of a transducer<sup>2</sup>
- > With "Multimeter" the ten multifunctional inputs of CMC test sets can be used for analog measurement<sup>2</sup>

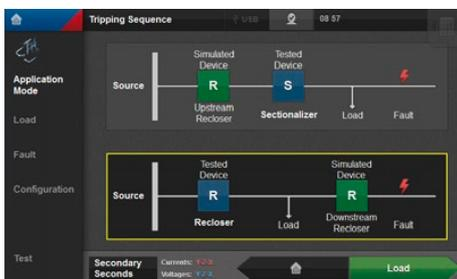

## CMControl R

The CMControl R is specifically designed for testing recloser and sectionalizer controls with CMC test sets. The software is adapted to the typical processes for testing recloser and sectionalizer controls. The menu navigation guides the user step by step through the test sequence. Test results are obtained quickly and reliably.

The test tools of the CMControl R provide diverse functionality:

- > "Analog Output Check" allows controlling of analog test quantities and operational measuring values
- > The "Pick-Up/Drop-Off" tool is used to test the thresholds of recloser and sectionalizer controls
- > The "Direct" tool enables individual configuration of all CMC outputs for special test tasks
- > The "Tripping Sequence" tool tests the controller main functions: permanent fault, autore-closure logic
- > The "Trip Time Characteristics" tool checks the operating characteristics and the switch logic between the fast and the slow curve
- > The "Restoration" tool allows testing of voltage controlled functions – e.g. automated distribution restoration schemes



<sup>1</sup> For testing protection and measurement equipment, it is also possible to control a CMC with an Android tablet and the CMControl P App. Further information see page 50

<sup>2</sup> CMC 256plus, CMC 256-6, or CMC 356 with ELT-1 hardware option



OMICRON's commitment to innovation is also found in its powerful Test Universe software suite designed to control CMC test sets<sup>1</sup> from a PC<sup>2</sup>. The OMICRON Test Universe functionality includes

- > convenient PC controlled manual testing
- > testing with software modules optimized for specific test object functions
- > generic testing allowing the creation of tests for special requirements
- > combining all these elements in overall test plans
- > using predefined test templates provided by OMICRON

### Manual Testing

Quick PC controlled manual testing is easy with the QuickCMC module, by setting the voltage and current values, phase angles, frequencies, etc., either numerically or in the vector diagram. Additionally this module performs standard power system calculations, allowing the entering of the settings in symmetrical components, power values, impedances, etc. The module displays the binary input signals and performs time measurements. Together with the step and ramp function, thresholds such as pick-up values can be determined.

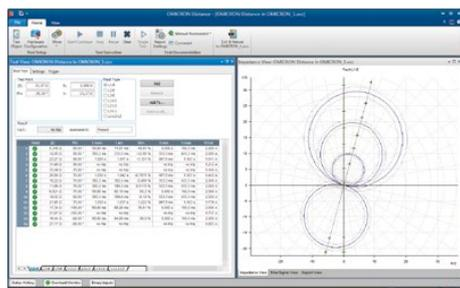

### Modules for Testing Particular Test Object Functions

Besides PC controlled manual testing, OMICRON's Test Universe software provides a variety of automated testing possibilities in dedicated modules especially designed for individual test object functions, e.g. for testing overcurrent relays, distance relays, or differential relays. In these modules, a specific graphic representation of the protection device's characteristic (I/t diagram, impedance plane, etc.) allows the graphical definition of test specifications as well as the visualization of the test results directly in the relay's characteristic diagram.

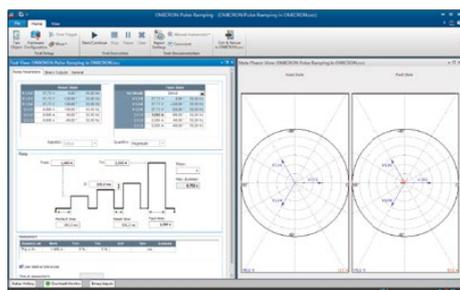

### General Functionality

For creating and performing special tests not covered by the function related modules, the Test Universe software also comprises generic test modules.

Such tests for instance can be

- > sequences of output states – controlled by time or the reaction of the relay under test with assessments based on time measurements
- > linear or pulsed ramping of electrical quantities with assessment based on the level of starting or resetting

Besides the generic test modules OMICRON offers a wide variety of additional software that works with the CMC test sets (e.g. IEC 61850 testing solutions, network simulation software, etc.).

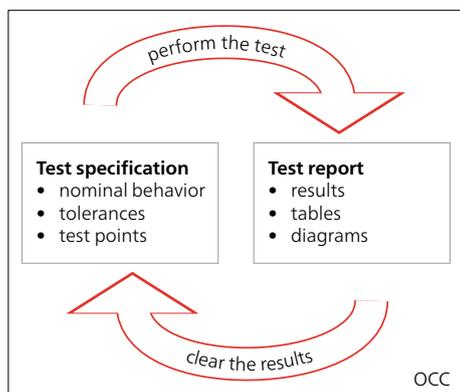

### OMICRON Control Center – Test Plans for Multifunctional Test Objects

In order to test the many functions of digital relays, the OMICRON Control Center (OCC) allows the combination of individual testing functions into an overall test plan. When performing a test, each embedded function will be executed sequentially and an overall test report including the results of all the functions tested is created automatically.

Since the test documents hold the complete test specification – i.e. the nominal behavior (settings) of the test object, the tolerances and the test points, with which this shall be verified – such a document is the basis for the repetition of the same test at a later time by reloading it, clearing the results of the previous test, replaying the test plan and saving the new results. Thereby tests, which have been created once, can be repeated for maintenance testing. This assures a constant testing quality and the possibility for direct comparison of results, also saving time when performing routine tests.

<sup>1</sup> CMC 356, CMC 256plus, CMC 353, CMC 256-6, CMC 156 (EP), and CMC 850

<sup>2</sup> OMICRON's Test Universe software 3.0 is tested to be compliant to the following versions of Microsoft Windows: Windows XP (32 bit), Windows Vista (32 bit), Windows 7 (32 bit and 64 bit), Windows 8 (32 bit and 64 bit)

# Test Universe

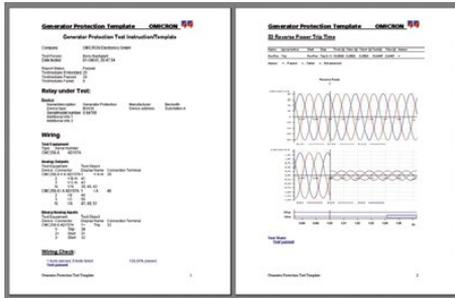

## Automatic Reporting

All test modules of the Test Universe software have a common element – the reporting function: Each module provides a fully formatted test report. Depending on the module the results come from, data is entered in tabular and/or graphical form. If several modules are used within the OCC to comprise a test, each module adds its specific piece of data to the overall report. After testing is finished, test results and assessments are entered automatically to complete the report. Reports can easily be printed, saved on file or in a database, or exported to standard office applications using Rich Text Format (RTF) and TXT format.

Customizing test reports based on individual requirements is easy. The visible content of test reports can be defined independently from the recorded data, by just selecting or deselecting items from the list. Recorded data will always remain available, regardless of whether the user chooses to include them in the reports. Defined report settings are quickly and easily generated, saved with a form name, and reloaded at a later time; company specific elements like logos etc., can easily be included.

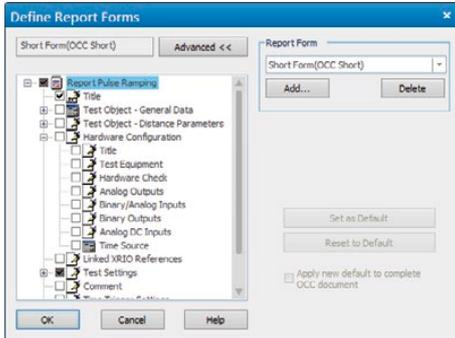

## Exporting test results

Besides the standard export formats TXT and RTF for further use of the data, such as in Microsoft Word, OMICRON Control Center documents provide the following two export formats for more extensive external post-processing of test data: The well-known CSV format and the XML (Extensible Markup Language) Data Export. CSV and XML Data Export are also available in all test modules in stand-alone mode. XML is a character based data format that supports a non-proprietary method of interfacing the test data with any third-party database (e.g. Microsoft Access, Microsoft SQL Server).

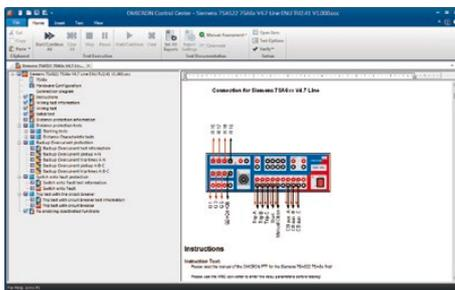

## Protection Testing Library

For mastering the challenge of testing modern multifunctional relays, OMICRON provides a library of protection testing templates, the Protection Testing Library (PTL). This library offers OMICRON customers access to prepared test plans and relay models of various manufacturers (ABB, Alstom, Areva, GE, Reyrolle, Schneider, SEL, Siemens, Toshiba, etc.) as well as parameter import filters for specific protection devices, which includes

- > relay modeling – i.e. calculation of the characteristics (such as zone diagram, ...) and tolerances from the relay settings – taking into account the technical characteristics as specified in the relay manual
- > import filter for importing setting values from the relay's software or from setting calculation tools
- > test routine for common relay functions.

This not only helps to save the time normally needed to manually create the relay characteristics and test templates but also let users benefit from OMICRON's testing know how such as on how to model and test specific relays and their functions in the Test Universe software. New templates are continuously being added to the PTL and are available for customers to download from the OMICRON website.

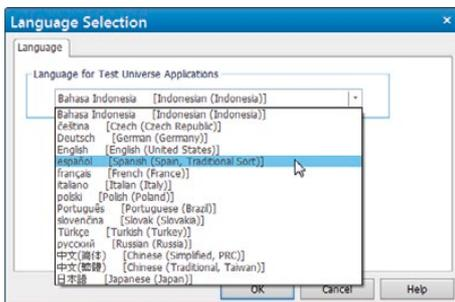

## Languages

The Test Universe software is available in 15 standard languages. Changing the system language is possible at any time just by selecting the requested language in the "language selection". All languages are automatically installed; no installation of any additional software components is required.

Especially in international projects, clients many times wish to get a report in a different language than the commissioning engineer's preferred working language. This is easily possible for all available standard languages. When the system language is changed and an existing test document is re-opened, the test report is automatically switched to the new system language set.

OMICRON customers benefit from a wide range of powerful software options. Various packages contain a selection of Test Universe test modules that are function-oriented and can operate either on a stand-alone basis or can be embedded in test plans for fully automated testing. Software for special applications complete the range.

### Software / Modules

		Software Packages						
		Basic	Protection	Advanced Protection	Recloser	Meter	Measurement	Universal
		Ba	Pr	AP	Re	Me	Mt	Un
QuickCMC	Quick and easy PC controlled manual testing	•	•	•	•	•	•	•
State Sequencer	Determining operating times and logical timing relations by state-based sequences	•	•	•	•			•
Ramping	Determining magnitude, phase, and frequency thresholds by ramping definitions	•	•	•	•			•
TransPlay	Playback of COMTRADE files, recording of binary input status	•	•	•	•	•	•	•
Harmonics	Generation of signals with superimposed harmonics	•	•	•	•	•	•	•
Binary I/O Monitor	Status display of all binary inputs and outputs of the test setup	•	•	•	•	•	•	•
CB Simulation	Module for setting the CB simulation	•	•	•	•	•	•	•
Polarity Checker	Wiring check using the optional CPOL hardware	•	•	•	•	•	•	•
AuxDC Configuration	Setting of the auxiliary DC supply	•	•	•	•	•	•	•
Pulse Ramping	Determining magnitude, phase, and frequency thresholds by pulse ramping definitions		•	•	•			•
Overcurrent	Automatic testing of positive/negative/zero sequence overcurrent characteristics		•	•	•			•
Overcurrent Char. Grabber	Extraction of overcurrent inverse-time characteristics from data sheet		•	•	•			•
Distance	Impedance element evaluations using single-shot definitions in the Z-plane		•	•				•
Differential	Single-phase tests of the operating characteristic and the inrush blocking of differential relays		•	•				•
Autoreclosure	Testing of the autoreclosure function with integral fault model		•	•				•
Advanced Distance	Impedance element evaluations using automatic testing modes			•				•
VI Starting	Testing of the voltage dependent overcurrent starting function of distance relays			•				•
Advanced Differential	Comprehensive three-phase differential relay testing			•				•
Annunciation Checker	Verification of the correct marshalling and wiring of protection devices			•				•
Synchronizer	Automatic testing of synchronizing devices and synchro-check relays			•				•
Transient Ground Fault	Simulation of steady state and transient ground-faults in isolated or compensated networks			•				•
Advanced TransPlay	Playback and processing of COMTRADE, PL4, or CSV files			•				•
Meter	Testing of single and multifunction energy meters					•	•	•
Transducer	Testing of measurement transducers						•	•
Control Center Package	Automation tool, document-oriented test plan, template and report form. Including OMICRON Control Center (OCC), Pause Module, ExeCute, TextView, CM Engine		•	•	•		•	•

### Additional Software

NetSim	Network simulator for relay testing under real life conditions
EnerLyzer™	Analog measurements and transient recording with the CMC 356 or CMC 256plus
TransView	Transient signal analysis for COMTRADE files
PQ Signal Generator	Simulation of power quality phenomena according to IEC 61000-4-30

### IEC 61850 Testing Tools

GOOSE	Testing with GOOSE according to IEC 61850
Sampled Values	Testing with Sampled Values (SV) according to IEC 61850-9-2 ("9-2 LE")
IEDScout	Universal software tool for working with IEC 61850 IEDs
SVScout	Visualizing IEC 61850 Sampled Values and testing of merging units

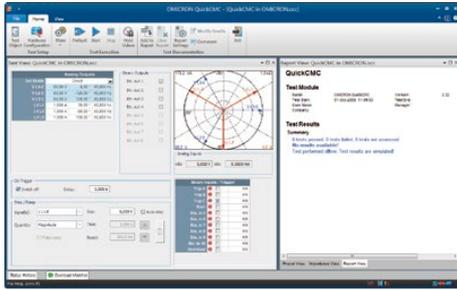

## QuickCMC

### Quick and easy PC controlled manual testing

- > Simultaneous control of all available test signals (voltage and current outputs) of the CMC test set in magnitude, phase, and frequency (max. 22 channels possible<sup>1</sup>)
- > Steady state, step or ramp function for all quantities
- > Fault Calculator providing different operation modes
- > Timing measurements
- > Vector view and impedance plane

QuickCMC provides an easy and intuitive user interface, while also offering powerful functions for performing PC controlled manual tests for all kinds of protection relays, measurement transducers and other equipment.

Analog Outputs			
Set Mode	Fault values		
Fault Type	L1-L2-L3		
V Fault	57,73 V	90,00 °	50,000 Hz
I Fault	2,000 A	10,00 °	50,000 Hz
Angle(V-I)	80,00 °		

Analog Outputs			
Set Mode	Z%-I const.		
Fault Type	L1-E		
Z%	10 %	Line length	
Phi Z	4,00 °	Link to line angle	
ITest	2,000 A		

Analog Outputs			
Set Mode	Powers		
S1 ( P1 , Q1 )	50,00 W	-16,67 var	50,000 Hz
S2 ( P2 , Q2 )	50,00 W	-16,67 var	50,000 Hz
S3 ( P3 , Q3 )	50,00 W	-16,67 var	50,000 Hz
Sv ( P , Q )	150,0 W	-50,00 var	50,000 Hz
V L1-E	57,73 V	0,00 °	50,000 Hz
V L2-E	57,73 V	-120,00 °	50,000 Hz
V L3-E	57,73 V	120,00 °	50,000 Hz

Output quantities can either be entered in the classical way as voltages and currents, or by using input modes for absolute or relative impedance values, powers or symmetrical components. Regardless of which input mode is chosen, Fault Calculator transfers the values into voltages and currents to be generated by a CMC and/or an amplifier unit.

### Output functions

QuickCMC provides simple control of test signals. Output values may be defined numerically, or by dynamically positioning the elements in the vector diagram or the interactive impedance plane with the mouse.

The module includes the Fault Calculator which automatically converts the entered values to determine the correct output quantities (voltage, current and phase angle) for single-, two- and three-phase faults, power flow, or symmetrical components. The residual voltage and current is also automatically calculated and generated. According to the selected mode, the values are displayed graphically in the vector or impedance view, as well as numerically in a table.

Channels where no fault model is assigned can be set without any restriction (unbalanced signal generation, variable frequency for each individual channel, etc.). The Unit Manager function allows for easy toggling between the handling of values in primary/secondary, absolute/relative, or seconds/cycles.

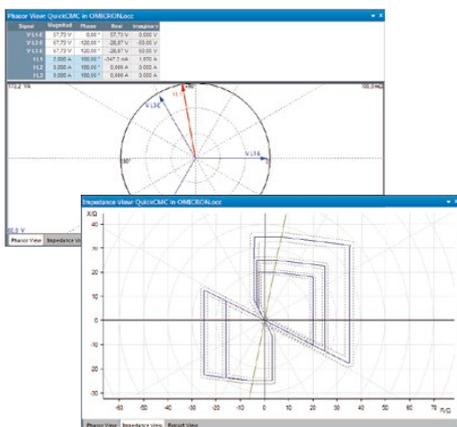

### Step or Ramp Mode

Step or Ramp Mode operation is provided for finding limiting values, such as pick-up and drop-off, or starting of a relay. In Step Mode, the selected quantities (currents, voltages, impedances, power, etc.) are increased or decreased by a specified value with a mouse click. In Ramp Mode, the defined step is repeated until an input toggles (e.g. when the relay trips). The pulse ramping functionality allows easy testing of protection elements with overlapping characteristics (e.g. testing the I >> threshold).

### Input/measuring functions

10 binary inputs can be used to monitor dry or wet contacts and make corresponding time measurements. The time measurement may alternatively trigger on the external interruption of the generated currents, allowing direct assessment of CB contacts. The output values of a transducer connected to the analog DC inputs can also be displayed.

### Reporting

Results of tests with QuickCMC can be stored for later use. Similar to all other testing modules in the OMICRON Test Universe software, the report style and content can be customized. In addition, the QuickCMC reporting feature provides a "notepad" function, so that individual comments may be added to the report.

<sup>1</sup> For CMC test sets equipped with LLO-2 option



## State Sequencer

State Sequencer is a very flexible test module for determining operating times and logical timing sequences. A state is defined by the output conditions (voltages and currents, binary outputs) and a condition for the transition to the next state. Several individual states can be put together consecutively in order to define a complete test sequence. The transition from one state to the next may take place after a fixed time, after the occurrence of a trigger condition at the binary inputs of the CMC, or after a GPS or IRIG-B trigger (e.g. for synchronized end-to-end testing with multiple CMCs). Looping of the sequence or static output of individual states is also possible.

### Definition of individual states

Within one state, all configured test signals (voltage and current outputs) of the used test device can be set independently in amplitude, phase, and frequency. Besides the direct input of the individual voltages and currents, the integrated Fault Calculator allows the automatic calculation of the test quantities. These can be entered as fault values, power values, symmetrical components, or impedances (with constant test current, constant test voltage or constant source impedance model). For distance relays, test points can directly be defined in the interactive impedance plane showing the nominal characteristic of the test object.

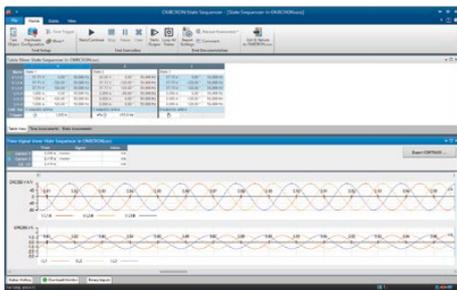

### Measurement

Time measurement conditions can be defined to check the correct operation of the relay. Individual response times and tolerances can be specified for each measurement condition, allowing a fully automatic assessment of the results. If the measured time is within the tolerance range, the test is "passed"; otherwise, it is "failed".

Apart from timing measurements (always triggered by an event, e.g. a trip) level assessments can be made. A level assessment is positive, if defined states at the relay outputs connected to the binary inputs are logically true throughout a certain state.

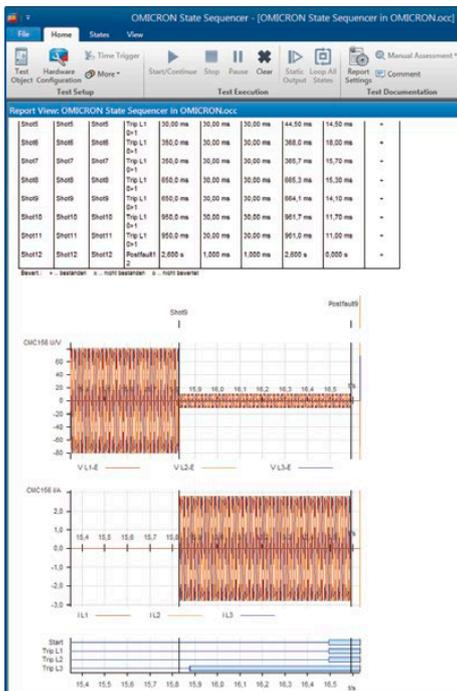

### Assessment and reporting

The measurement conditions are displayed in a table. After a test execution this table also contains the actual measured times and deviations and the automatic assessment of the results. The last column contains the "passed" or "failed" information. All of the time signals (voltages, currents and binary inputs) can be displayed graphically to aid in studying the reaction of the relay. Signals can be enabled individually, with the ability to zoom in on specific points in time. Data cursors facilitate scrolling through the time signals to find the values at specific times.

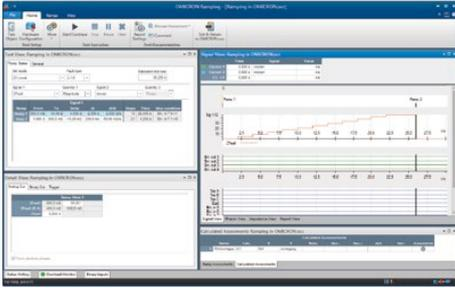

## Ramping

Ba	Pr	AP	Re	Me	Mt	Un
•	•	•	•	•	•	•

The test module Ramping determines limiting values, such as minimum pick-up or switching hysteresis (e.g. pick-up/drop-off ratio). It generates ramps of amplitude, phase, or frequency for the current and voltage outputs.

Automated tests can be performed with ramps that allow testing of both simple and complex functions. The flexibility of this module allows two synchronized simultaneous ramps of different variables (including ramping two components of the same output signal, e.g. magnitude of fundamental and harmonic) with any number of ramp segments.

### Features

- > Automated testing using ramp sequences
- > Simultaneous ramps for two independent variables and functions (e.g. V/Hz)
- > Definition of an arbitrary number of consecutive ramp segments
- > Visual control of the output values (time signal view)
- > Test repetition feature with statistic calculations
- > Ratio calculations of the two ramp values, e.g. pick-up/drop-off ratio
- > Unique one-step-back feature for quick and accurate testing
- > Display of the test results with automatic result assessment

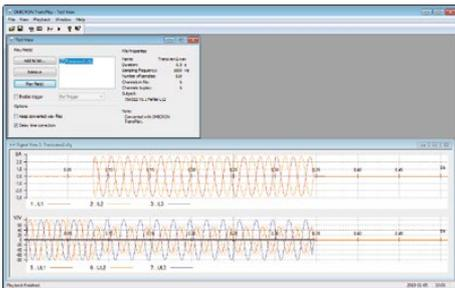

## TransPlay: Transient Playback Tool

Ba	Pr	AP	Re	Me	Mt	Un
•	•	•	•	•	•	•

TransPlay allows the loading and playback of transient files containing voltage and current analog transient waveforms. COMTRADE files can be automatically played back. This results in the injection of these signals into the relay. These signals may be simple harmonic waveforms or actual power system faults recorded from a digital fault recorder or calculated by a simulation program, such as EMTP. The playback length is only limited by the size of the harddisk.

The software supports the following file formats:

- > IEEE COMTRADE (C37.111-1991 and P37.111/D11-1999) respectively IEC 60255-24 (for replaying records with multiple sampling rates Advanced TransPlay is required)
- > Microsoft Windows WAV

TransPlay also includes synchronizing capability for use with an external trigger. An external trigger, such as a time pulse from a GPS satellite receiver (e.g. CMGPS 588), can initiate the playback of a transient file at a specific time.

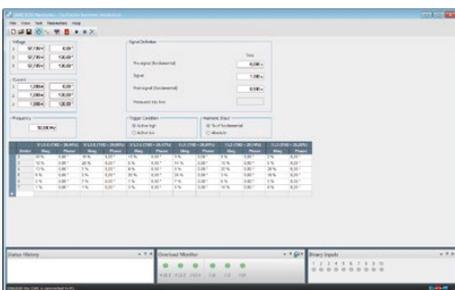

## Harmonics

Ba	Pr	AP	Re	Me	Mt	Un
•	•	•	•	•	•	•

Harmonics generates test signals consisting of a fundamental voltage or current signal and superimposed harmonics. Depending on the used CMC test set, signals with a frequency of up to 3 kHz (i.e. 60<sup>th</sup> harmonic at 50 Hz or 50<sup>th</sup> harmonic at 60 Hz) may be generated.

Harmonics allows defining the fundamental of three voltage and three current signals, and – superimposed on those – any combination of even and odd harmonics. The harmonics thereby can be entered either in percentages or absolute values. Harmonic signals can be output directly or exported as COMTRADE files.

Harmonics features both a static output mode and a sequence mode. In sequence mode a sequence consisting of three states can be injected:

1. Pre-signal: fundamental wave
2. Signal: fundamental wave and harmonics
3. Post-signal: fundamental wave

A timer starts at the moment of harmonic injection and stops on a trigger event. The response time is indicated.

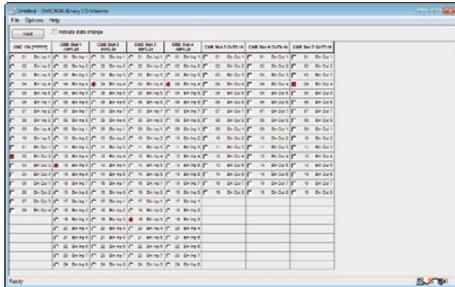

### Binary I/O Monitor

Ba	Pr	AP	Re	Me	Mt	Un
•	•	•	•	•	•	•

Binary I/O Monitor displays the status of all binary inputs and outputs of the connected CMC and binary extension devices. It can also indicate transient changes that occur between regular updates of the displayed information. This is very useful during the creation of a test sequence or for troubleshooting. A hold function enables the user to “freeze” the display for detailed investigations. In particular when working with binary extension devices this tool provides considerable benefit. A typical application is the testing of the control logic of a bay control device.

Main functions:

- > All connected binary inputs and outputs are monitored
- > Runs in parallel with any OMICRON test module
- > Transient changes can be indicated through the “Indicate state change” function
- > Display can be frozen by the “Hold” function



### CB Simulation

Ba	Pr	AP	Re	Me	Mt	Un
•	•	•	•	•	•	•

CB Simulation simulates the auxiliary contacts of a circuit breaker (CB) during a test (for relays requiring a connection and operation of those contacts for proper functioning). Depending on the available binary inputs and outputs, it is possible to simulate one-pole and three-pole operation of the CB. A time signal display shows the actual situation. The timing parameters and the mode of operation of CB Simulation is specified in CB Configuration. The actual simulation is controlled by the CMC firmware, allowing real-time responses of the simulated auxiliary CB contacts (52a, 52b) to trip and close commands. CB Simulation is supported by CMC 356, CMC 353, and CMC 256plus.



### Pulse Ramping

Ba	Pr	AP	Re	Me	Mt	Un
•	•	•	•	•	•	•

With the Pulse Ramping test module, quick, accurate and thorough determination of pick-up values of multifunctional relays is easily done. Pulse Ramping allows for testing a protection element pick-up value without disabling associated functions. This eliminates a potential source of error as no disabling of relay functions is required. The use of Pulse Ramping also avoids high continuous testing current for electromechanical relays with high instantaneous settings.

Other functions include:

- > Distance protection fault model
- > Reset state definition
- > End-to-End testing using a GPS trigger or IRIG-B
- > Automatic report creation
- > Automatic result assessment

Typical applications: Pick-up testing of

- > multifunctional relays with overlapping elements
- > overcurrent relays with multiple elements
- > generator protection
- > motor protection
- > rate of change relays (including df/dt)

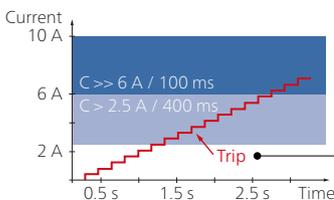

Application Example Overcurrent:

With the Ramping test module, the  $I >>$  pickup (instantaneous) cannot be determined because the ramp already leads to a trip in the  $I >$  (timed overcurrent) area

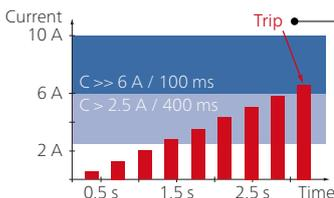

With the Pulse Ramping module the determination of the  $I >>$  pickup value is possible because the 200 ms pulses do not force a trip in the  $I >$  region.

Ba	Pr	AP	Re	Me	Mt	Un
	•	•	•			•

## Overcurrent

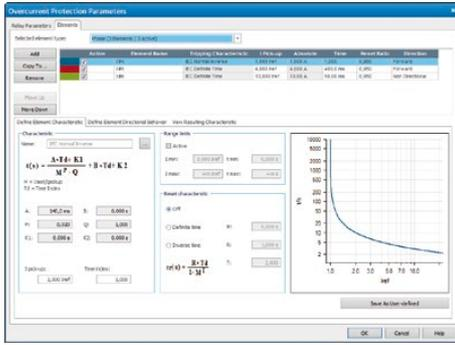

The Overcurrent test module is used for automatic testing of directional and non-directional overcurrent relays with auto-assessment of the trip time characteristic, the directional boundaries of the current stages, and the pick-up/drop-off ratio. With its flexible directional boundary definition it is also perfect for testing the characteristic of steady-state ground fault relays.

The test module supports directional sector definition and any number of line, ground, positive sequence, negative sequence, and zero sequence elements. For each element the trip characteristic can be individually selected and displayed in the I/t diagram and the directional diagram.

In Overcurrent the set of test shots can be defined concurrently for all desired fault loops. This is possible for the following fault types:

- > Line to line fault
- > Line to ground fault
- > Line fault with suppressed residual current (for individual phase testing without ground starting)
- > Negative sequence
- > Zero sequence

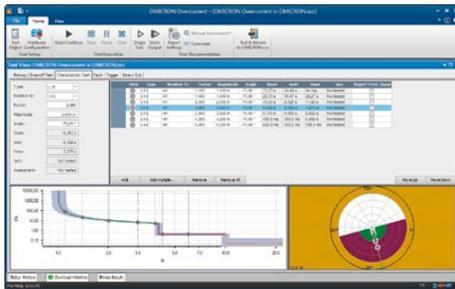

The software overlays the characteristics of each of the elements in both the I/t diagram and the directional diagram. This includes all of the elements which respond to the type of fault applied. For each test shot an assessment of the relay's performance is made based on the allowable tolerances for the measurement of the current and the operating time.

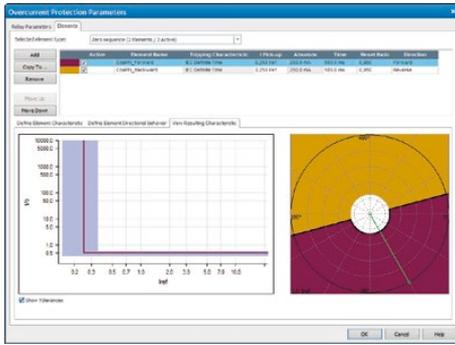

### Key Features

- > Unrestricted characteristic element definition (characteristic type, directional sector)
- > Assessment for each test shot considering all active elements
- > Simultaneous availability of all element types and characteristics
- > Testing of all fault types and loops together in one test module
- > Definition of test point sequences (in terms of fault type, current magnitude variation, and current angle variation)
- > Testing of the pick-up/drop-off characteristic with automatic assessment
- > Testing with or without load current
- > Automatic reporting

The time characteristics can either be entered directly in current/time tables or based on a wide range of pre-defined relay characteristics. Hierarchically structured templates for the following relay characteristics are included: Inverse-time characteristics as defined by IEC 60255-4 (BS 142), IAC type characteristics, and relay specific curves based on the IEEE equation (PC37.112). Variants of these characteristics support commonly used relay types. Additional variants may be added to the template file, including curves digitized with the Overcurrent Characteristics Grabber (see below). PTL test templates add relay-specific support by mapping the relay settings to the overcurrent module parameters and providing sample test sequences.

Ba	Pr	AP	Re	Me	Mt	Un
	•	•	•			•

## Overcurrent Characteristics Grabber

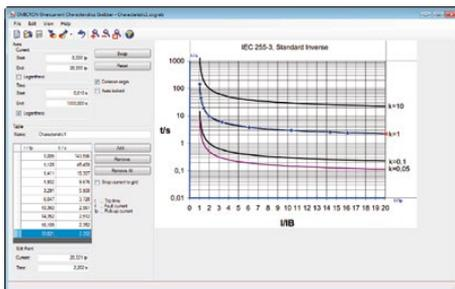

The Overcurrent Characteristics Grabber tool is a supplement to the Overcurrent test module. It helps to extract inverse-time overcurrent relay tripping characteristics from graphical representations. This is most helpful in cases where the characteristic is not known by a given formula but only by a graphical representation, e.g. an image in a relay manual.

This tool loads a scanned image of the characteristics and guides the user through scaling of the I and t axes and successive digitizing of I/t data pairs along the displayed tripping characteristic curve. The resulting characteristics curve value table then is transferred to the Overcurrent test module for performing tests with automatic assessments.

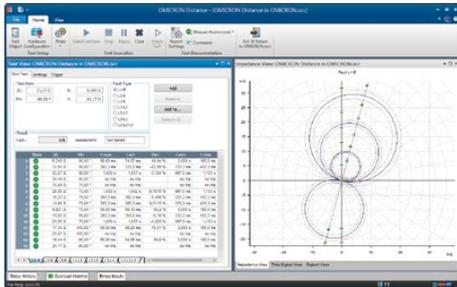

## Distance

Ba	Pr	AP	Re	Me	Mt	Un
	•	•				•

Distance provides the functionality to define and perform tests of distance relays by impedance element evaluations using single-shot definitions in the Z-plane with graphical characteristic display.

### Definition of relay characteristics

The nominal relay characteristics and settings can quickly and easily be defined by a graphical characteristic editor. Starting, trip, extended, and no-trip zones are defined by using predefined elements. A complete overview of all defined zones is provided. The standard XRIO interface<sup>1</sup> makes it possible to directly import the relay data from the relay's parameter setting software (if supported by the relay manufacturer). The impedance settings for the zones can be entered and displayed in primary or secondary values.

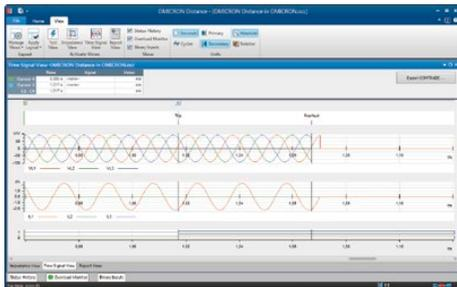

### Definition of tests

Tests are defined in the impedance plane by entering the test points to a test point table. This table is divided according to the different fault loops (A-N, B-N, C-N, A-B, etc.). Test points can be defined for several fault loops at the same time (e.g. for all single-phase loops), or for every fault loop separately.

When a test is performed, the test point lists of the individual fault loops are processed sequentially. The reaction of the relay is compared to the specified nominal settings and an automatic assessment is made ("passed" or "failed"). The results are displayed graphically in the impedance plane, as well as numerically in the test point table. For a more in-depth analysis of the results, the voltages and currents related to a test point and the relay's reaction can be graphically displayed. Time measurements between different points can be made using cursors.

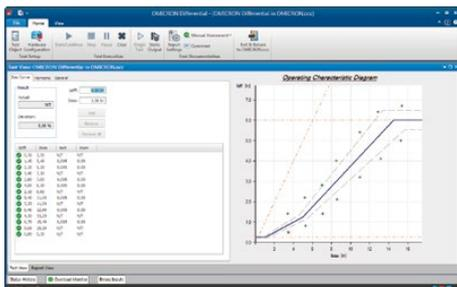

## Differential

Ba	Pr	AP	Re	Me	Mt	Un
	•	•				•

Differential provides a compact testing solution for transformer, line, generator, and busbar differential protection relays. It performs single-phase tests of the operating characteristic (pick-up value, slope test) and the inrush blocking function (harmonic restraint test).

Variable tap settings, as for some older electromechanical relays (e.g. Westinghouse HU, or GE BDD) can be addressed. For the operating characteristic test, test points are defined in the Idiff/Ibias plane. A graphic user interface makes the test definition easy.

Differential also tests the harmonic restraint function. For this function, the test points are determined by the differential current and the percentage of the superimposed harmonic. The test currents belonging to the test points are injected into the relay and the reaction of the relay is assessed.

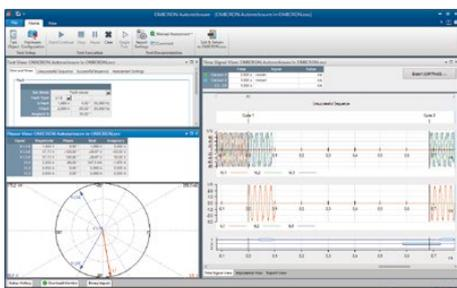

## Autoreclosure

Ba	Pr	AP	Re	Me	Mt	Un
	•	•				•

Configuration of the test sequences for the autoreclosure (AR) function of protection relays is both effective and time saving. The Autoreclosure test module automatically sets up test conditions for successful and unsuccessful sequences. Essential criteria, like the three-phase final trip at the end of an unsuccessful sequence are automatically evaluated as well.

Overcurrent, distance, or line differential relays with autoreclosure function can be tested. The faults are specified by entering the fault type and fault quantities. This is supported by the integrated Fault Calculator which calculates the output voltages and currents for the different fault types. For testing the autoreclosure function of distance protection, the fault can be specified in the impedance plane.

The test sequence is displayed over time and a list of events with assessments is reported.

<sup>1</sup> Details see page 25

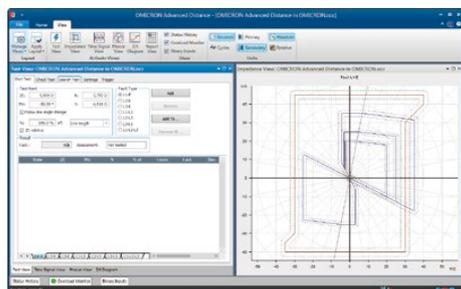

## Advanced Distance

In addition to the base functionality of the Distance test module, Advanced Distance provides the following advanced functionality:

- > Search and Check tests of the zone reaches
- > Test settings relative to zone reaches and line angle ("relative shots")
- > Constant source impedance test model
- > Load current superimposition

### Shot test, Search test, and Check test

In a Shot test, single test points are added to a test point table and are automatically processed (see Distance test module).

In a Search test, zone reaches are determined automatically. Zone transitions are searched along search lines specified in the impedance plane, using an optimized algorithm. It is possible to define a series of search lines. All defined search lines are stored in a table for automatic processing.

In a Check test, test points are automatically set at the tolerance boundaries of zones. The setup is done with test lines (check lines) similar to a search test, but test points are only set at the intersections of the check lines with the zone tolerances. The Check test is an efficient overall test of the relay with minimum testing time. This gives a quick verification of whether the specifications are met, particularly for routine tests.

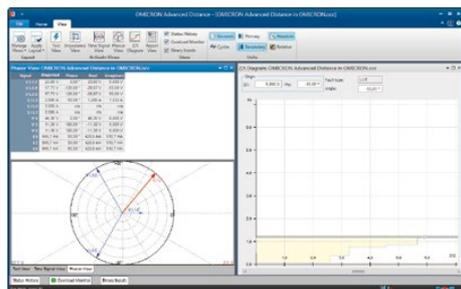

Adding test points and test lines to the tables is possible in a variety of ways. Parameters can be precisely defined by numerical inputs, or specified directly in the characteristic diagram. A magnetic cursor supports the choosing of meaningful values. Mouse commands, context menus and keyboard shortcuts facilitate data input.

A test in Advanced Distance can have any combination of Shot, Search, or Check tests. At test execution, the whole test settings are executed sequentially. This versatile system offers a wide range of testing possibilities. Using this, it is easy to comply with most different testing philosophies and regulations.

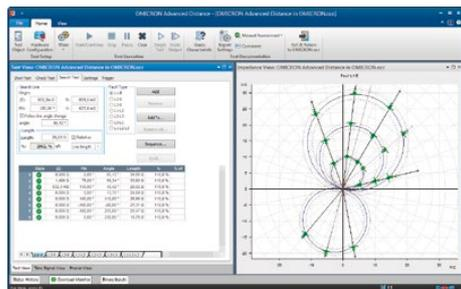

### Relative test definitions

A powerful feature is the possibility to make test point definitions relative to the nominal characteristic of the distance relay (e.g. 90 % of zone 1, 110 % of zone 1, 90 % of zone 2,...). Test points are not entered in absolute R, X, Z, or angle values, but are referred to zone reaches and the line angle instead. This feature allows the creation of re-usable test templates, which adapt themselves to the actual relay settings.

### Constant source impedance model

Besides the constant test current and constant test voltage models, Advanced Distance provides the constant source impedance test model which is useful in special cases where parameters such as SIR (Source Impedance Ratio) are important.

### Load current

To verify special behavior of certain relays which occurs only when a pre-fault (load) current is present (e.g. accelerated tripping performance), a load current can be superimposed.

### Testing multiple fault loops in one test module

Advanced Distance provides special support by performing the tests for multiple fault loops (L-N, L-L and L-L-L) within one test module. For all test modes (Shot, Search, Check) multiple tabs are provided with a separate test point table for every fault type. Test settings can either be entered fault-loop-specific or defined simultaneously for multiple fault types.

### Distance Characteristic Guesser

If the nominal characteristic of a relay should be unknown or the actual characteristic shape is to be documented, a guesser function allows the automatic generation of an approximated characteristic based on the results of a Search and/or Shot test. The calculated characteristic can be saved and further used as the relay's nominal characteristic.

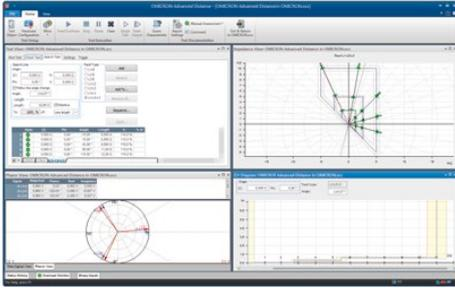

### Multi-windows user interface

The user interface can be configured individually, using the following elements:

#### Test View

This view holds the test point tables for the Shot, Search, and Check tests and the impedance plane. Test definitions are made in this view. During and after the test execution, this view displays the results numerically in the tables and graphically in the impedance plane.

#### Z/t Diagram

This view shows the graded trip time curve over the impedance along a certain line. The actual line is determined in the impedance plane or by a selection in the test tables. It is also possible to define test points and to view the assessments in the diagram.

#### Vector Diagram

The vector diagram shows the phasors of the voltages and currents, both for the phase quantities and the sequence components. The corresponding numerical values are displayed in the attached table.

#### Time Signal View

After a completed shot the voltages, currents, and binary signals are shown in this view. This is useful to perform more detailed investigations (e.g. time measurements using cursors).

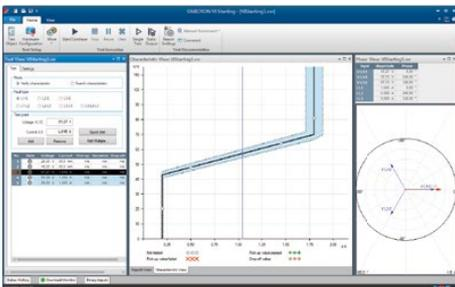

### VI Starting



VI Starting tests the voltage dependent overcurrent starting characteristic used in many distance relays. Additionally, it is a perfect tool for many tests on overcurrent and undervoltage functions. For any specified test point, it detects the pick-up value, the drop-off value, and the ratio.

#### Benefits

- > Automatic finding of characteristics
- > Automatic testing according to specified characteristics
- > Automatic determination of pick-up and drop-off values
- > Separate characteristics for phase-to-ground and phase-to-phase starting
- > Intuitive operation with graphical representation of the test
- > Clear representation of results in tabular and graphical form

#### Features

- > Easy fault specification with fault type and fault quantities
- > Generation of realistic test quantities with models for phase-to-ground, two-phase and three-phase faults
- > Vector diagram with additional numeric display of the test quantities
- > Automatic result assessment
- > Automatic test report generation

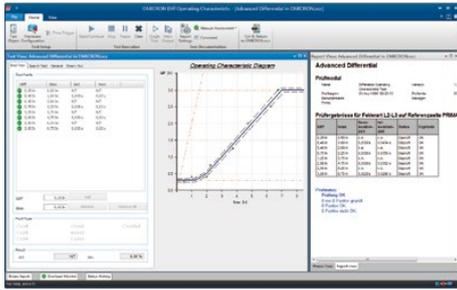

## Advanced Differential

Advanced Differential is a set of test modules which form a complete testing solution for differential schemes. It is particularly suitable for transformer differential schemes with up to 3-windings and up to nine currents to be injected.<sup>1</sup>

Extensive modeling of the protected object (e.g. power transformer), the secondary equipment (CTs, CT connection) and the relay characteristics provides the data for the calculations required to facilitate testing. The automatic calculation of the test currents eliminates the most time consuming and error-prone manual tasks. Testing the correct operation of the relay becomes simple, time saving, and cost efficient.

This test solution provides:

- > Testing with all fault types (L-N, L-L, L-L-L)
- > Shot tests at pre-defined test points or search tests
- > All shots synchronizable to GPS or IRIG-B for end-to-end testing (e.g. line differential protection)
- > Evaluation and assessment of results against nominal characteristics and tolerances
- > Report generation including graphical representation of the results in the characteristic diagrams
- > No blocking of voltage related functions required (important for testing of multifunctional relays)

For transformers, automatic calculation of currents to be injected are based on:

- > Transformer data (nominal data, vector group)
- > CT ratios and connections
- > Fault type
- > Fault/supply side (primary, secondary, etc.)
- > Load current
- > Amplitude and phase correction

For the protective relay, the assessment of the measured values is based on:

- > Operating characteristic
- > Bias calculation
- > Zero sequence elimination

If a suitable combination of a CMC and an additional amplifier unit is used, the modules can control up to nine currents for comfortable testing of three-winding transformer protection.

For non-transformer applications, such as testing generator differential protection, the current calculations are done without the transformer model. These test modules are also suitable for testing other differential relay functions such as an overcurrent back-up protection function or an overload function integrated into the relay.

Details of the four test modules in Advanced Differential:

### Diff Configuration

This module simulates through-faults to verify that the protection is stable for faults outside the protected zone. Since investigation of the stability may require the observation of multiple measurements, the module gives the tester the option to check the readings before proceeding with the test. The actual values read from the relay under the fault conditions (operating or restraint currents of the different phases) can be entered in the report for full documentation.

The test module Diff Configuration tests:

- > Secondary wiring and interposing transformers (electromechanical and numerical relays)
- > Correct parameter setting of digital relays (specification of protected object)
- > Zero-sequence elimination

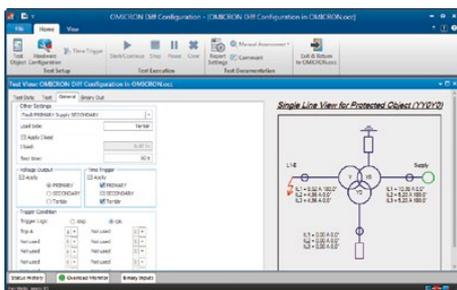

<sup>1</sup> To make full use of the typical applications of Advanced Differential a CMC test system providing more than three current outputs is required

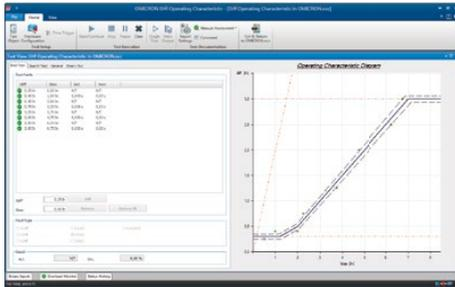

### Diff Operating Characteristic

The Diff Operating Characteristic module tests the operation of the protection for faults inside the protected zone.

The currents injected into the relay are calculated from  $I_{diff}/I_{bias}$  value pairs specified in the  $I_{diff}/I_{bias}$  plane. This relates directly to how manufacturers commonly specify the operating characteristic. The correct reaction of the relay, either trip or no trip, is assessed against the specified characteristic.

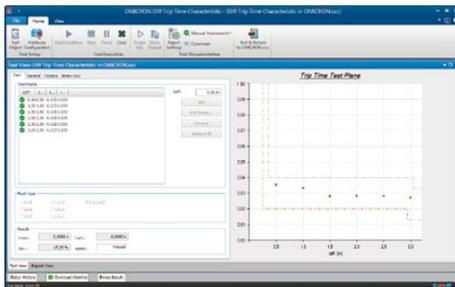

### Diff Trip Time Characteristic

This module tests the dependency of the trip time from the amplitude of the differential current.

Diff Trip Time Characteristic measures tripping times at specified differential currents. The actual test currents for the specified differential currents are automatically calculated. The test points are defined in the trip time characteristic diagram and the measurements are assessed against this characteristic.

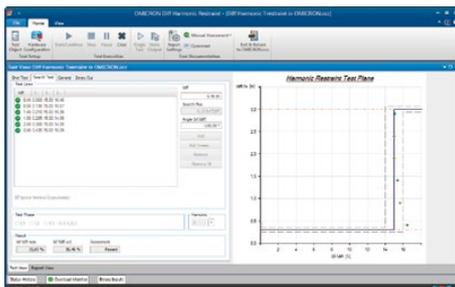

### Diff Harmonic Restraint

Diff Harmonic Restraint tests the inrush and CT saturation blocking function of a differential relay. The test points are defined in the harmonic restraint characteristic diagram, where the differential current is drawn over the harmonic content of the test current.

For simulating different inrush conditions, the initial phase shift between fundamental and harmonics can be specified.

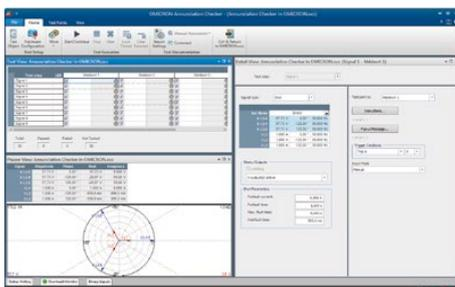

### Annunciation Checker

Ba	Pr	AP	Re	Me	Mt	Un
		●				●

Today's protection devices emit dozens of different status signals or measured analog values. Each signal can be displayed at various locations.

Annunciation Checker helps the commissioning engineer to verify that the allocation of each message to its expected location (marshalling) and the wiring has been done correctly. A test specification can be created prior to the test and can also be flexibly adapted while a test runs. The test specification is done in a signal/location grid.

Signals stimulate a protective device and are generated as shots or steady states. The test engineer can navigate through the test grid in any order (e.g. signal by signal or location by location). Each cell of the grid corresponds to a signal indicator at a certain location. The response of the indicator is evaluated automatically. The test results are summarized in a tabular test report.

Annunciation Checker is a typical commissioning tool used in conjunction with the central SCADA operator. It provides a work plan (points list) and a good source of documentation.

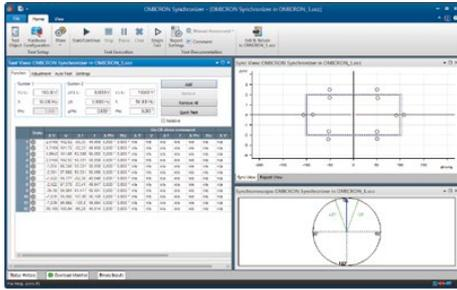

## Synchronizer

The Synchronizer test module simulates two systems to be synchronized (1 and 2): System 1 representing the mains is fixed in amplitude and frequency, system 2 is controlled in amplitude and frequency and represents the generator or system to be synchronized.

Using the module in single-phase to single-phase mode (each system represented by one voltage) is possible with any CMC test set. With a CMC 356, CMC 353, or CMC 256plus, three-phase to single-phase synchronization is possible, using the additional fourth voltage phase to represent the second system. If a CMS 156 with its three voltage channels is used additionally together with a CMC test set, Synchronizer even allows a three-phase to three-phase synchronization.

The software automatically detects the circuit breaker closing command from the synchronizing device or synchro-check relay and, taking the CB closing time into account, evaluates if the synchronization takes place inside the synchronizing window. The control of the second output is variable following different test modes. The frequency and amplitude can be changed linearly depending on the ramping time constants of the generator.

For synchronizing devices with automatic adjustment functions, the adjustment control commands ( $f\uparrow$ ,  $f\downarrow$ ,  $V\uparrow$ ,  $V\downarrow$ ) may be used to control the second voltage output. To simulate the real system as closely as possible, dynamic generator models are available. The binary contact sequences of the adjustment commands, and the changes of voltage and frequency, can be monitored graphically in order to follow the progress of the synchronization.

An implemented synchroscope displays the rotating voltage vector of system 2 respectively the moment of synchronization.

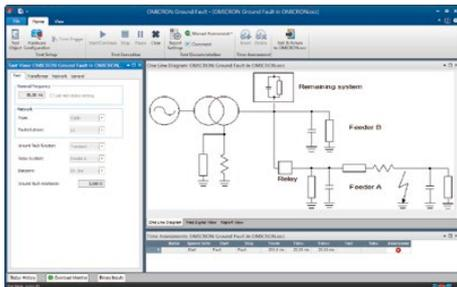
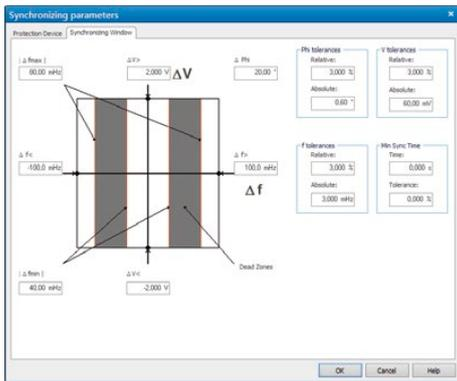

## Transient Ground Fault

Transient Ground Fault tests the directional decision of transient ground fault relays in grids with isolated or compensated grounding. It produces the transient voltages and currents during a ground fault from a fault simulation with a pre-defined network model. The network simulation provides testing with realistic current and voltage waveforms. The model simulates a spur line. The calculated quantities are determined by the parameters of the line and the feeding network.

For testing the directional decision of steady-state ground fault relays, the steady-state fault quantities after the decay of the transient process can be continuously output. To allow for the testing of relays in both the forward and the reverse direction, the fault can be applied on different feeders.

The module performs an automatic assessment of the measured data based on the user's specific application. The output signals are shown in a separate view. They can also be displayed or printed with the automatically generated test report. The test execution can be manually initiated or synchronized by using an external trigger signal.

- > setting the relay
- > checking the relay's directional characteristic

Both three-phase systems and two-phase systems (e.g. for railway applications) can be simulated.



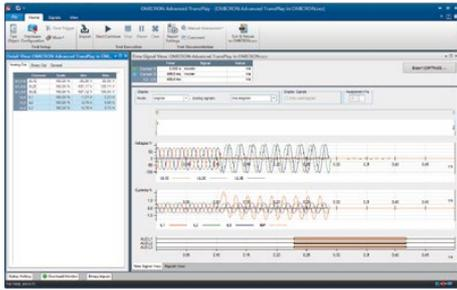

## Advanced TransPlay

Advanced TransPlay enables the CMC system to test with transient signals. Transient signal data, obtained from fault recorders, CMC 356 or CMC 256plus with EnerLyzer, or network simulation programs, can be loaded and viewed, processed, and replayed with Advanced TransPlay. The reaction of the protection device tested with such signals is recorded and assessed, and a test report is generated.

- This makes it an ideal tool for
- > troubleshooting with fault records
  - > relay evaluation with transient files (e.g. EMTP calculations)
  - > end-to-end testing

Advanced TransPlay supports the following file formats:  
IEEE COMTRADE (C37.111-1991 and P37.111/D11-1999) respectively IEC 60255-24, PL4 and CSV.

After a transient file has been loaded, the part of the signal to be replayed is selected by markers. It is possible to repeat parts of the signal, e.g. for extending the pre-fault time. Markers can be set in order to point out significant events in the recording, such as fault inception, starting, tripping, etc. These markers are the basis for time measurements.

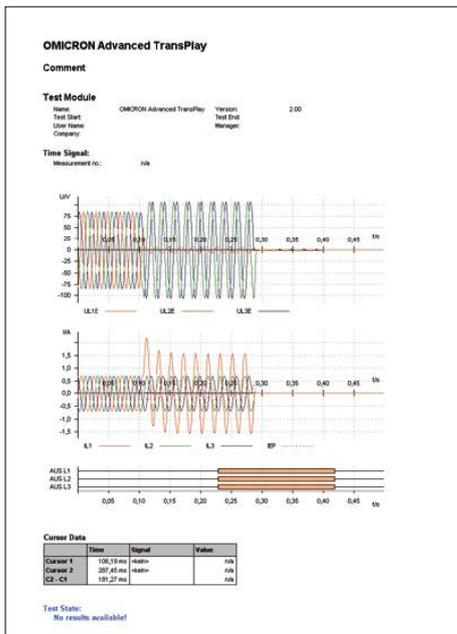

Besides playing back voltage and current signals, Advanced TransPlay can also replay the binary signals in a fault recording via the CMC's binary outputs. Additional binary signals (e.g. carrier send/received signals from communication-based schemes) can be added. During playback, the selected voltage, current, and binary signals are applied to the protection device. Playback can be synchronized via GPS, IRIG-B protocol or by a time pulse applied to a binary input.

- The reaction of the protection device is measured and assessed on the basis of time measurements. Absolute and relative time measurements are possible:
- > Absolute time measurements determine for instance starting or trip times of the relay during signal playback
  - > Relative measurements compare the relay's reaction during playback to its behavior stored in the recording (reference)

- This makes it possible to investigate
- > if the relay scatters (differences between recording and actual behavior during playback)
  - > how a different protection device operates under the same conditions

Advanced TransPlay provides a repetition mode; the individual results for each repetition, as well as average and standard deviation values (statistic functions), are displayed.

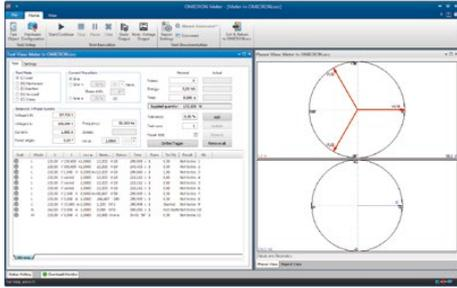

## Meter

Until now, the usual method for testing of energy meters has been to use a stabilized, but not very accurate, power source, in combination with a high-precision reference meter. OMICRON's approach significantly simplifies meter testing. By using state-of-the-art hardware technology, OMICRON provides test sets that are so accurate and stable, that the signal source itself becomes the reference and make a reference meter unnecessary.

The CMC test sets not only provide the test signals, but also have inputs for the meter pulses allowing closed loop testing. To this end, optical scanning heads for capturing pulses emitted by the meters (infrared LEDs) are available. Meter allows for manual or automated testing of energy meters.

Each line of the test table represents a test point, which can be run in one of the following modes:

- > Load test Accuracy of measurement unit (time power method)
- > Mechanism test Accuracy of entire meter including display
- > Gated Mechanism test Testing internal meter registers
- > Injection test Quick check (wiring, sense of rotation)
- > No-load test No start-up at zero load
- > Creep test Start-up at low loads

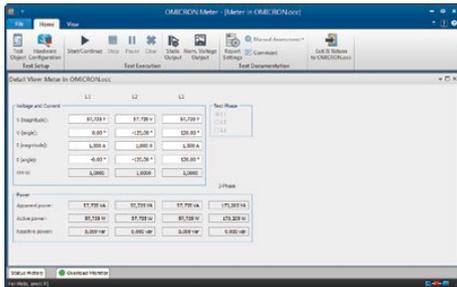

In the columns of the table the individual test parameters, the set assessment criteria (tolerance, nominal behavior), and the result of the test, including the assessment (passed or failed) are displayed. For multifunctional meters, or meters with two directions of rotation, a table per test function is available (multiple tabs). Test lines can be repeated several times. In this case the standard deviation is displayed together with the meter error, which allows conclusions of the correctness of the test itself. Single test steps (e.g. those assessed as failed) can be repeated after a test run is finished, without the need for repeating the whole test.

For testing the behavior of meters with harmonics or DC components, the following current signal waveforms are available:

- > Sine
- > Sine + Harmonics
- > Sine + DC

The test quantities are displayed graphically by means of the voltage, current and power vector diagrams.

The test can be performed with any balanced or unbalanced load for:

- > Single phase meters (or a single measurement element of a 3-phase meter)
- > 3-wire meters
- > 4-wire meters

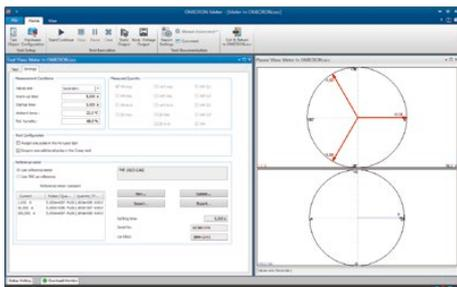

In a detail view, all parameters can be specified independently for each phase. Apparent, active and reactive power is indicated for each phase and the whole rotary system. Testing of the following meter functions is supported:

- > Wh importing/exporting
- > VArh importing/exporting
- > VAh
- > I<sup>2</sup>h and V<sup>2</sup>h (load/no-load losses of transformers)
- > Qh (quantity hour)

The results of an automatic test are clearly summed up in a tabular test report (one line per test point). For a manual test, generating any test quantities, without defining a complete test procedure, can quickly check the correct functioning of meters. In this mode the constant of a meter can also be determined, in case it is not known or if there are doubts about it.

Also operation in conjunction with an external reference meter is possible: When testing with a reference meter, the CMC is used as a current and voltage source. During a load test, the pulses of the meter under test as well as those of the reference meter are registered. The latter form the reference for error calculation.

Furthermore, testing against a 0.02 or 0.01 % reference before a test is run, using the same test points, can eliminate errors of the CMC by loading correction values.

## Transducer

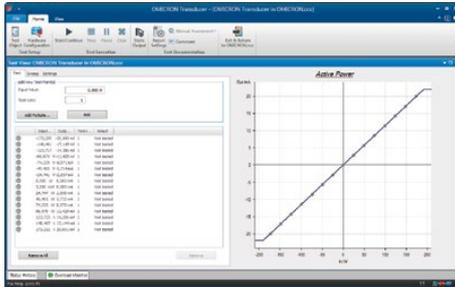

The software module for testing measurement transducers enables a CMC<sup>1</sup> for manual or automatic testing of any measurement function, such as:

- > Real power (single- or three-phase)
- > Reactive power (single- or three-phase)
- > Apparent power (single- or three-phase)
- > Frequency
- > Current
- > Voltage (phase-to-ground, phase-to-phase)
- >  $\cos \phi$
- > Phase angle (V-I, V-V, I-I)
- > DC quantities (current, voltage, power)
- > Signed average of currents

The module supports testing of the following types of characteristics:

- > Linear
- > Compound
- > Quadratic
- > Symmetrical or non-symmetrical



The “manual test” mode is used, if a measurement transducer is to be re-adjusted. Every desired input quantity can be generated for the transducer. Furthermore, it is easy to switch between significant points of a characteristic, where the error of the transducer is shown at a certain input value.

An automatic test includes the sequential output of a pre-defined test point table, as well as the documentation and assessment of the results. Here, the test points represent the input value of the measurement transducer. In addition, the behavior at changing input voltage or frequency can be performed as an option.

The error of a transducer is determined by comparing the theoretical signal and the actually measured output signal. Relative, absolute and device errors are derived and graphically displayed in a diagram. If multiple test runs are performed, the average error is indicated.

Single test points or test sequences can be added to the test point table. The table includes: Input value, output value, device error and assessment (test passed or failed).

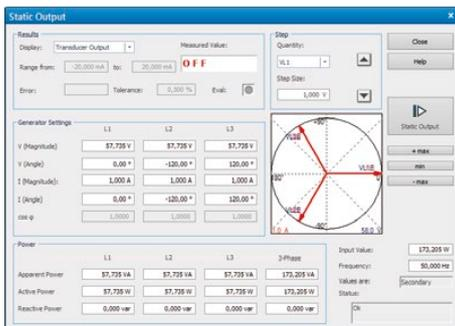

During the automatic test run all test points are processed in a sequence. The transfer characteristic including all test points (passed or failed) is displayed graphically. If remote displays should be checked during the test run, the test can also be controlled manually.

Measuring transducers for three-wire (Aaron circuit) as well as four-wire systems can be tested. Currents as well as voltages can be generated as pure sine signals or superimposed with harmonics or DC components. New generation transducers often no longer have classical mA or VDC output. They rather transmit the measured data via transfer protocol or/and visualize values at a display. The mode “open loop testing” supports testing this type of transducer.

<sup>1</sup> CMC 256plus, CMC 256-6, CMC 156 (EP), or CMC 356 with ELT-1 hardware option. If Transducer is ordered together with a new CMC 356, ELT-1 is included. Used CMC 356 test sets without ELT-1 can be upgraded.

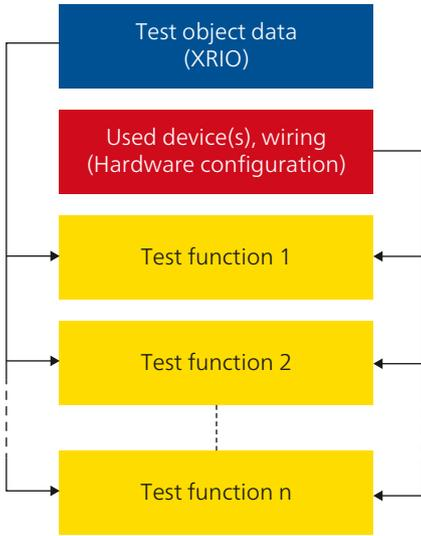

## OMICRON Control Center

OMICRON's software modules feature comprehensive functionality for conventional manual or automatic testing. Unique, however, are the automation possibilities the OMICRON Control Center offers. Comprehensive test plans can easily be built, maintained and distributed. Testing times can be significantly reduced.

With the patented<sup>1</sup> OMICRON Control Center (OCC) technology all functions of a test object can be tested with one test plan, defined within an OCC document. Basically, an OCC document comprises the following elements:

**Test object data** Defined in XRIO format, a powerful test object environment to describe/model all test object parameters and settings. Test object data can be entered manually or be imported. XRIO Converters make the setting transfer from the relay to the test software fast and easy.

**Information on the device(s), outputs and inputs, wiring connections** Specified in the Hardware Configuration. Present throughout a test plan for all embedded test functions/modules.

**Test modules with test settings (test points, etc.)** Number and type of embedded test modules depending on the complexity of the tests to be performed. Tests automatically adapt to changed test object settings, as these are transferred from the overall test object definition. With the LinkToXRIO technology, all "general" test modules have access to all relay parameters – including user-specific ones – and allow using them for the definition of the test points and assessment conditions.

**Optional: Graphics, instruction texts, etc.** Guide the tester through the testing process according to test specifications (connection diagrams, check instructions, etc.) supported by Pause Module, Text View, ExeCute.

**Results (after testing)** Contain all test results in secure format with exact data, automatic assessment of the test points according to tolerances, automatically created test report (customizable to meet the organization's requirements). Test results can be exported in RTF, TXT, CSV, and XML format.

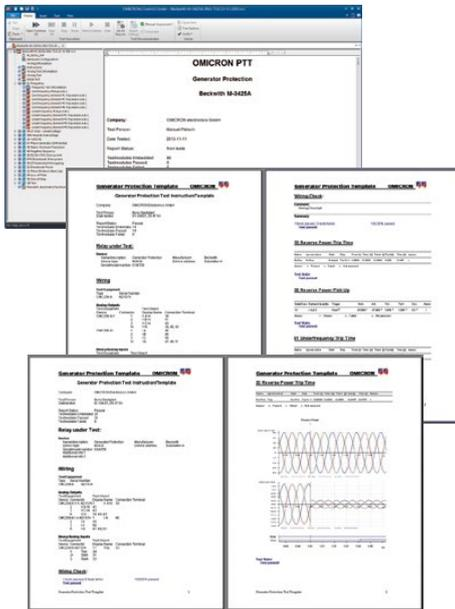

### Re-usability

OMICRON Control Center (OCC) documents can easily be used as templates for the same or similar test objects: Simply copying the OCC file, deleting the results of the previous test and restarting will perform the test again with the exact same settings, configuration, and test specifications. For similar tests, where only the settings differ (e.g. in substations with several feeders), simple copying of the OCC file and adjustment of the parameters is all that is required.

### Pause Module, Text View, ExeCute

These useful tools run within OCC and support the automation of test plans.

#### Pause Module

Allows the setting of breakpoints in automatic tests. Test designers can specify instructions to be displayed as pop-up messages (e.g. inclusion of a wiring diagram).

#### Text View

Allows for embedding and displaying a text file or log file during an automatic text execution.

#### ExeCute

Allows for execution of external applications (programs) along with file or data parameters during Control Center execution for an automatic test using an OCC document (e.g. automatic change of the relay settings during type testing).

<sup>1</sup> Patent Nos. EP 0904548 B1 and US 6418389 B2

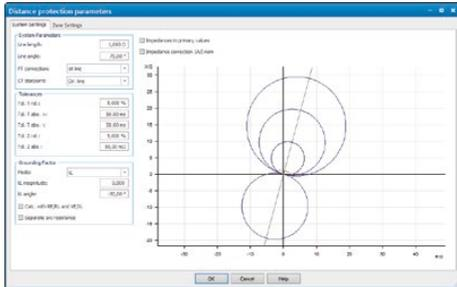

## Test Object Definition with XRIO

All the relevant data for a device to be tested is kept in the standard XRIO (eXtended Relay Interface by OMICRON) format. The corresponding data can either be manually entered or alternatively be imported. Test object parameters can also be exported, making them available across any existing test plans.

### LinkToXRIO

LinkToXRIO allow test modules the direct use of a defined test object parameter for testing. If a certain parameter changes, the test plans using it do not need to be modified. The test plans will perform their specified test then using the modified parameter.

### XRIO Converters

XRIO Converters optionally allow for the fast and easy entry and conversion of the data available in the relays' own parameter structure. A number of helpful examples are included in the software. XRIO Converters can be written and customized by the users. The growing library of relay-specific XRIO Converters is part of the standard delivery of the Test Universe software and also offered for free download in the customer area of the OMICRON website.

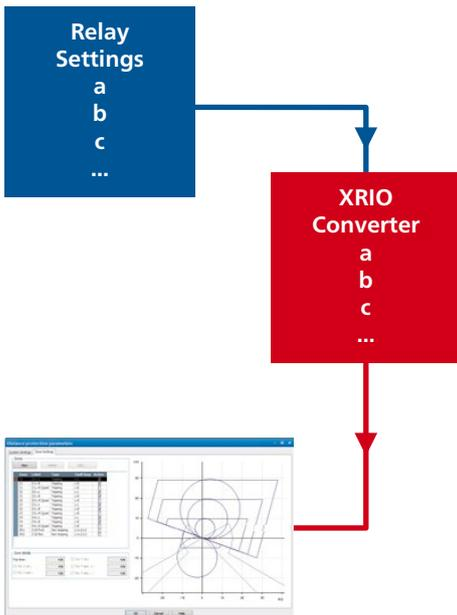

## PTL Protection Testing Library



Many relays, due to their complexity, can be very challenging to test and therefore make the testing process quite complex. This can be the cause for higher unscheduled additional expenses, affect the test duration which is especially disturbing when the substation is due to be energized imminently. Protection engineers are requesting tools that help them in a flexible manner in test scenarios that require manual testing as well as in automated and standardized testing.

OMICRON's innovative test software technology with the OMICRON Control Center, XRIO, and LinkToXRIO enables all users to create relay specific test templates that adapt to the actual parameterization of the relay. This is the technological basis of the Protection Testing Library (PTL). The library gives the protection engineers the possibility to benefit from the work that OMICRON spends to model multifunctional protection devices and to build test plans, and thus from the resulting testing know-how.

This library provides OMICRON customers free access to prepared test plans and relay models (XRIO Converters) as well as parameter import filters for specific protection devices. Based on the protection parameters and technical details documented in the manual of the particular protection device, XRIO Converters model the protection characteristics and tolerances (e.g. impedance zones, I/t diagram shape, etc.). Any user can easily extend or customize the test plans to meet the individual requirements.

The PTL is extended and maintained on a constant basis. The library for example provides access to templates and XRIO Converters for line, power transformer, and generator protection relays. Specific relay types of ABB, Alstom, GE, Schneider, SEL, Siemens, Toshiba, and other manufacturers are supported.

### Benefits:

- > Save Work and Time: Save the time it normally would take to manually create the relay characteristics and test templates. The relevant relay parameters can be readily entered into the XRIO Converter to view and test against that particular relay's characteristics.
- > Parameter Import: Relay parameters can be transferred manually or automatically (e.g. by using the Parameter Import Filters for the different relay types).
- > Know-How Source: Often relays have special behavior that makes testing challenging and time consuming. By using PTL files users benefit from OMICRON's application know-how.
- > No Programming: The PTL test templates do not require any programming or scripting.
- > Open System: The PTL templates and XRIO Converters are completely unprotected and open. In this way, users can adapt a template to exactly match their needs.

The PTL is integral part of the Test Universe software standard delivery and available for free download in the customer section of the OMICRON website.

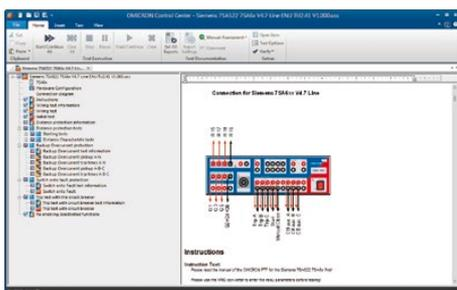

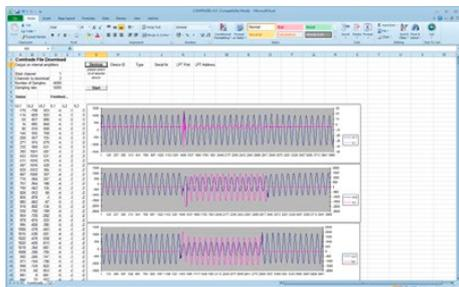

## CM Engine Programming Interface

Ba	Pr	AP	Re	Me	Mt	Un
•	•	•	•	•	•	•

For special applications, the programming interface CM Engine allows users of CMC test sets to write their own programs. Thus, specific test and control requirements can be met, such as factory tests as performed by protection relay manufacturers.

The programs can be written in one of the common programming languages such as C/C++, Visual Basic, C#, or LabView. It is also possible to control the CMC test hardware from third-party applications (like Microsoft Excel) that support Microsoft Automation.

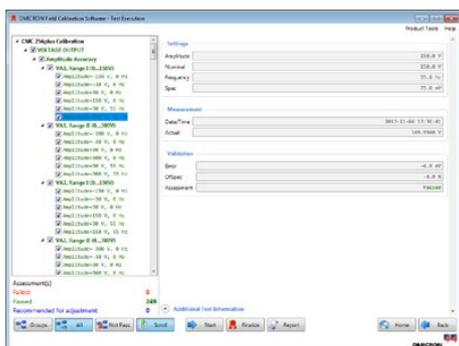

## FCS Field Calibration Software

Ba	Pr	AP	Re	Me	Mt	Un
•	•	•	•	•	•	•

The Field Calibration Software FCS supports users when performing a calibration or a self check. A number of test templates are available for the different CMC test sets and amplifier units. A calibration can be performed with any suitable reference device with sufficient accuracy. Users can perform a self check utilizing the CMC test set's own analog measuring inputs.

The software guides the user through the procedure and provides a calibration report. Before the decision is made to send a unit back to OMICRON for a factory calibration (always includes a re-adjustment), a field calibration using FCS can be performed at the customer's location. As long as the results documented in the calibration report are within specifications there is no need for a factory calibration. CMC test sets have very little drift over many years and thus the need for a factory calibration with adjustment arises only very rarely.

## PQ Signal Generator

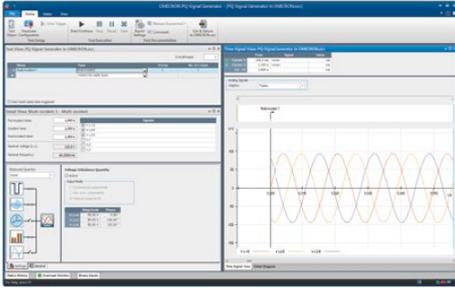

The need to verify the capability and reliability of power quality meters/analyzers requires appropriate calibration equipment. The PQ Signal Generator turns a CMC test set – ideally a CMC 256plus with its high-precision voltage and current outputs – into a calibration tool that generates all kinds of power quality phenomena according to IEC 61000-4-30 (-7, -15):

- > Power Frequency
- > Power Supply Voltage
- > Flicker
- > Dips & Swells
- > Voltage Interruption
- > Transient Voltages
- > Voltage Unbalance
- > Harmonics
- > Interharmonics
- > Rapid Voltage Changes

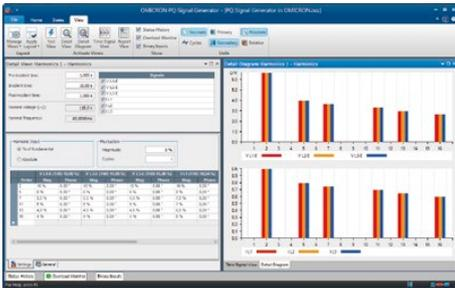

The PQ Signal Generator provides a powerful and easy to use interface; for example, flicker signals with rectangular or sinusoidal modulation can easily be generated. Flicker magnitude and flicker frequency starting from 1 mHz can be set individually by the user.

Based on tables 1 and 2 of the IEC 61000-4-15 standard, the PQ Signal Generator provides a selection of paired values for flicker frequencies and magnitudes. Each of these pairs results in a pre-determined Pst-value which can be used for the calibration of flicker meters.

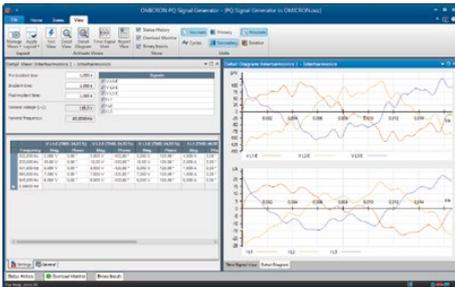

Depending on the type of CMC test set used, voltage and current signals with superimposed harmonics (up to the 60th harmonic at 50 Hz or 50th harmonic at 60 Hz) and interharmonics up to 3 kHz can be generated. Harmonic magnitudes can be entered either in absolute values or in percentages of the fundamental value. For advanced applications, even fluctuating harmonics can be generated. If only one interharmonic is used the frequency resolution for this is 1 mHz, moreover any combination of whole-number interharmonics can be set up.

The PQ Signal Generator makes the CMC the first commercial product to also provide easy support for the stringent testing in accordance with IEC 62586. This new standard prescribes test signals with which multiple power quality phenomena are simulated at the same time. An extensive testing library, consisting of 12 different OMICRON Control Center (OCC) files, is available to provide support in performing the type tests required by these standards.

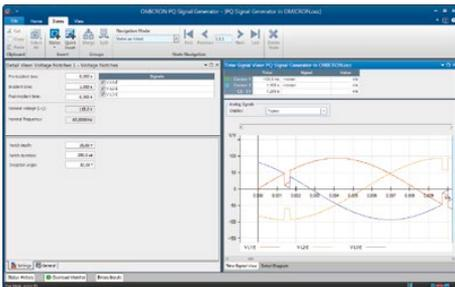

Another example of the module's versatility is the generation of cyclic notches. The notch depth and the angle of occurrence can be adjusted independently; the minimum gap-width for notches is 300  $\mu$ s. This function can provide the possibility to simulate the system perturbation of a thyristor-controlled motor.

The PQ Signal Generator allows the creation of comprehensive test sequences. Test steps can be grouped and run repeatedly in a user-definable number of loops. If the test object provides a binary output, it can be used for automatic assessment of the test results. If no alarm contact is available, manual assessment can also be performed.

In the past, the testing of PQ related equipment required a high level of investment in separate testing equipment. With the PQ Signal Generator module, the testing of PQ analyzers can be performed with the CMC test set quickly and easily.

# Additional Software

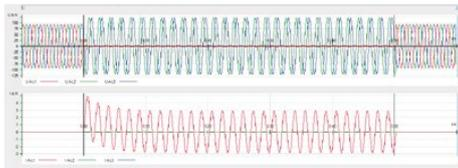

L-N Fault with CT saturation

## NetSim Network Simulation Software

VESM5100

The NetSim test module is designed for commissioning engineers and routine testers who want to benefit from the advantages of power network simulations and testing with transient signals. Preconfigured network configurations – test cases – with a simple parameter setup allow instant “click and run” simulations and signal output with the CMC test set.

### Application examples

- > Relay testing under real-life conditions
- > Evaluation of relay settings for difficult protection applications
- > Testing of advanced protection algorithms
- > Easy End-to-End testing of line protection with GPS or IRIG-B time synchronization
- > Testing of differential protection including CT saturation

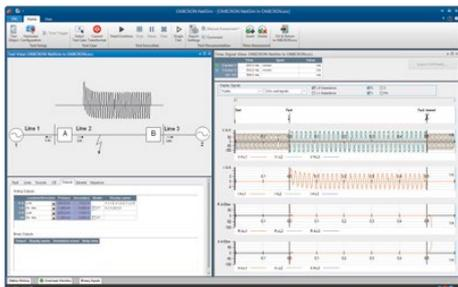

The transient voltages and currents are calculated from a digital network model, providing an optimal approximation of the real events in a power network. CT saturation may be simulated using real CT excitation and burden data for each measurement location. This data could, for example, be measured on site with the OMICRON CT Analyzer.

### Test cases

- > Short circuit events on single lines, parallel lines (including mutual coupling), and three terminal lines
- > Power swings
- > Evolving double faults
- > Series compensation capacitor bank
- > Transformer for through-fault and bushing fault simulation
- > Customized test cases (on request)

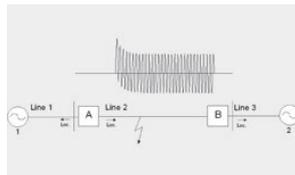

Single line

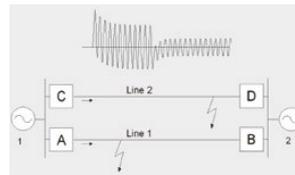

Parallel line

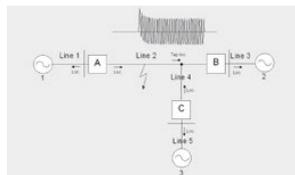

Three terminal line

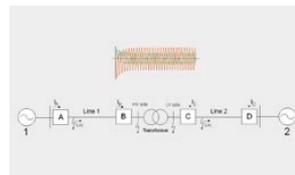

Transformer

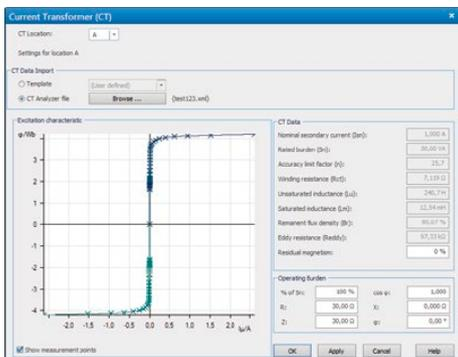

### Event simulation

- > Fault types L-N, L-L, L-L-N, L-L-L, L-L-L-L-N
- > Selectable fault location
- > Selectable fault resistance (arc simulation)
- > Simultaneous faults on parallel lines
- > Open phase
- > Spur line
- > Switch-onto-fault
- > Power Swing

### Further functions

- > Automatic repetition of tests with varying parameters
- > Impedance view including distance zones
- > Additional COMTRADE export of simulated waveforms
- > Output of the transient data of all measurement points as IEC 61850 Sampled Values and support of virtual binary GOOSE inputs and outputs

For the simulation of the power system all essential components and parameters are taken into account. This includes: voltage sources, lines (mutual coupling), transformer (vector group, core type and ratio), circuit breakers and CT saturation.

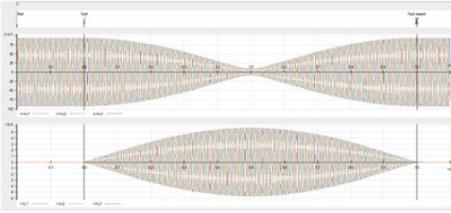

Voltages and currents during an asynchronous power swing

### Power swing testing

The realistic power system quantities generated by NetSim are essential for successfully testing advanced power swing blocking functions in modern relays. In this context, simple impedance ramps or sequences of impedance states are often not sufficiently realistic to test the function correctly. Asynchronous power swings can also be generated with multiple pole slips for effectively testing Out-of-Step (OST) functions. The synchronous power swing test case simulates a transient oscillation that returns to a stable state. In the impedance view the apparent impedance trajectory can be shown together with the relay distance zones.

### Three terminal line

Due to their cost benefits, tapped lines are being installed more frequently. Depending on the individual segment properties (e.g. cable tap on overhead line) or topographical layout (e.g. a tap is located close to one end) distance protection may have serious zone reach problems with this configuration. The three-terminal line test case included in NetSim is ideal for investigating fault conditions on tapped lines. Finding optimized protection settings for this difficult case is made much simpler.

### End-to-end testing application

Dynamic End-to-End testing of the complete protection scheme (e.g. for transmission lines) offers many advantages but is also subject to some limitations due to its high level of complexity, time consuming preparation, and the time available for the execution of the test. NetSim helps to overcome these through its intuitive operation, defined models, and instant calculation of the different test cases. Unlike other commonly used power system analysis software, NetSim is intended mainly for the needs of the protection engineer. It provides a direct output of test signals without the need for intermediate transient file handling steps. The support of the CMGPS 588 and CMIRIG-B units in NetSim allows the synchronization of test sets at each end of the line with precise test initiation and timing. In addition, it is possible to integrate a sequence of test cases into the OMICRON Control Center and execute the whole sequence with just one mouse click.

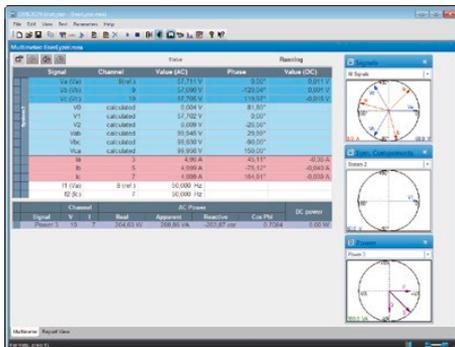

### EnerLyzer™

VESM2050

EnerLyzer is a software option for the CMC 256plus, CMC 256-6, or CMC 356<sup>1</sup>, enabling powerful analog measurement functions. With this option, each of the ten binary inputs can be re-configured for optionally being used as analog measurement inputs. Together with EnerLyzer a CMC becomes a multifunctional measurement and recording unit. EnerLyzer can be used in parallel with any active Test Universe test module or OCC test file.

Voltages of up to 600 VRMS can be measured. Alternatively, currents can also be measured by using current clamps with voltage outputs or measurement shunts<sup>2</sup>. Five measurement ranges make use of the optimal accuracy, matching the signals to be measured. The measurement data can be displayed as secondary or primary values. Results can be summarized in a measurement report.

### Multimeter

In this mode, all ten inputs can either be used as voltage or as current inputs. AC or DC values can be measured. For AC, two different frequencies can be determined (e.g. generator/ network).

EnerLyzer displays the following quantities:

- > RMS value and phase for V, I (AC)
- > DC values for voltage, current and power
- >  $\cos \phi$
- > Active, reactive, and apparent power per phase and three-phase
- > Symmetrical components
- > Line-to-line voltage
- > Two frequencies

<sup>1</sup> For CMC 356: ELT-1 hardware option required. If EnerLyzer is ordered together with a new CMC 356, ELT-1 is included. Used CMC 356 test sets without ELT-1 can be upgraded.

<sup>2</sup> EnerLyzer includes three C-Shunt 1 and three C-Shunt 10 (technical specification see page 55)

## EnerLyzer (continued)

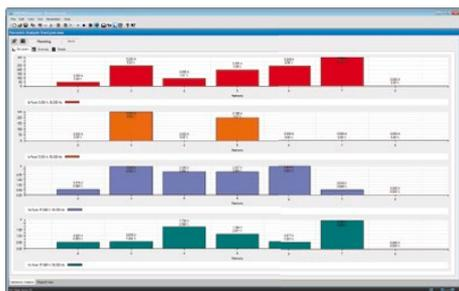

### Harmonic analysis

This mode allows the on-line analysis of signals up to the 64<sup>th</sup> harmonic (at 50/60 Hz).

EnerLyzer displays the following quantities:

- > Magnitude and phase of the fundamental
- > Frequency, magnitude and THD of the overall signal
- > Magnitude and phase of the harmonic

Signals can also be captured using a “snapshot” function and displayed graphically.

### Transient recording

With EnerLyzer, the CMC 256plus, CMC 256-6, or CMC 356<sup>1</sup> can be used as a powerful 10 channel transient recorder. The maximum recording time depends on the sampling rate and on the number of channels to be recorded (one channel recorded at 3 kHz yields a recording time of over 5 min.). Each recording is stored in COMTRADE format.

Visualization and in-depth analysis of transient recordings can be performed with the TransView software that is provided with EnerLyzer. Replaying of transient recordings is possible using either Advanced TransPlay or TransPlay.

Sampling rate, pre-trigger time and recording time can be set for each recording. Recording may be triggered manually or by a defined trigger. This can be a certain voltage, current or binary level with rising or falling slope, or a power quality phenomena.

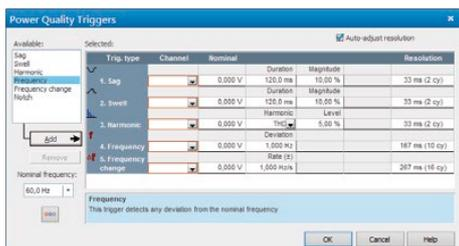

### Power quality triggers

Different power quality criteria can be combined to trigger signal recording:

- > Swell & Sag triggers: Trigger when a certain swell or sag occurs in a certain channel
- > Harmonic: Triggers when either a certain harmonic or the total harmonic distortion exceed a certain level specified as a percentage of the nominal value
- > Frequency: Triggers when the frequency exceeds the specified deviation from the nominal frequency
- > Frequency Change: Triggers when the rate of change of frequency exceeds the specified rate
- > Notch: Triggers after a certain number of notches of a certain duration and amplitude occur



### Trend recording

Records the following quantities over time:

- > Frequency 1 (any channel)
- > Frequency 2 (any channel)
- > Currents (RMS value)
- > Voltage (RMS value)
- > Phase angles
- > Real power (single and three phase)
- > Reactive power (single and three phase)
- > Apparent power (single and three phase)
- >  $\cos \phi$

Each type of quantity (e.g. frequencies, currents, or real powers) is displayed in a separate diagram over time. Measurements over a very long period of time are possible by choosing a large measurement rate – setting a rate of 10 s will allow a continuous measurement over several weeks. If the limit is exceeded recording is continued and the oldest samples are removed from the chart.

Recorded data can be exported for further processing into the CSV file format.

<sup>1</sup> For CMC 356: ELT-1 hardware option required. If EnerLyzer is ordered together with a new CMC 356, ELT-1 is included. Used CMC 356 test sets without ELT-1 can be upgraded.

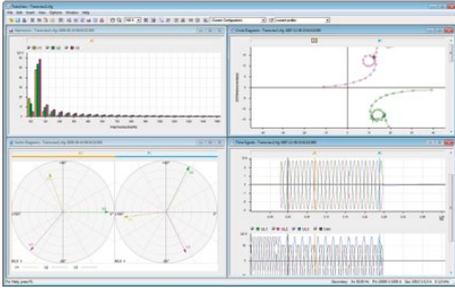

## TransView

TransView is a software for visualization and analysis of recorded analog and binary signals, or transients in the network, which were recorded with transient recorders (relay-internal recording, CMC with EnerLyzer, DANEO 400, disturbance recorder). It processes the recorded data graphically and calculates further quantities of the energy system out of the measurement data, like impedances, power vectors, RMS values, etc..

The quantities can be represented as primary or secondary values in different views:

- > Time signals
- > Vector diagrams
- > Locus diagrams
- > Harmonics
- > Value tables



For the analysis of a transient recording, amplitude and time measurements can be performed using two cursors. The voltage and current values on the cursor positions are displayed in the vector diagram or the value table. In every view, the zoom function allows the representation of the values with optimal scale. TransView allows for simultaneous analysis of multiple recordings, e.g. of the two ends of a line.

### Time signals

Analog and binary signals are represented as a function over time. Analog quantities can be displayed as instantaneous or RMS values.

### Vector diagrams

This view visualizes measured and calculated quantities (e.g. symmetrical components) as complex vectors at defined points in time.

### Locus diagrams

This view visualizes complex quantities as locus diagrams. Impedance locus diagrams can be represented together with tripping zones of distance relays. Zone settings can be imported using the XRIO format.

### Harmonics

The Harmonics view shows the RMS values of harmonics of selected measured quantities as bar graphs. The amplitude values are given in absolute values and as a percentage of the fundamental. The harmonics are determined using a full-cycle DFT (Discrete Fourier Transformation).

### Value table

The Table view shows the values of several signals at the cursor positions. The signals are arranged in rows, where the individual columns contain the respective values.

TransView supports data in COMTRADE format (C37.111-1991 and P37.111/D11-1999).

Note: TransView can be used

- > as part of EnerLyzer (no separate order required)
- > as part of the Test Universe Software (without EnerLyzer) [VESM2052]
- > as stand-alone application without CMC / Test Universe Software [VESM2051]

# IEC 61850 Testing Tools

OMICRON provides the most advanced IEC 61850 testing tools for protection engineers. The tools complement each other to serve different needs.

For protection testing utilizing IEC 61850 GOOSE and Sampled Values, corresponding functions “wire” CMC test sets<sup>1</sup> to the station network. With IEDScout, the data models and configurations of IEC 61850 compatible devices can be investigated. The usage of configuration information in standardized SCL (Substation Configuration Language) format is supported throughout the whole tool set. The OMICRON SVScout software makes Sampled Values visible for the substation engineer and IED developer.

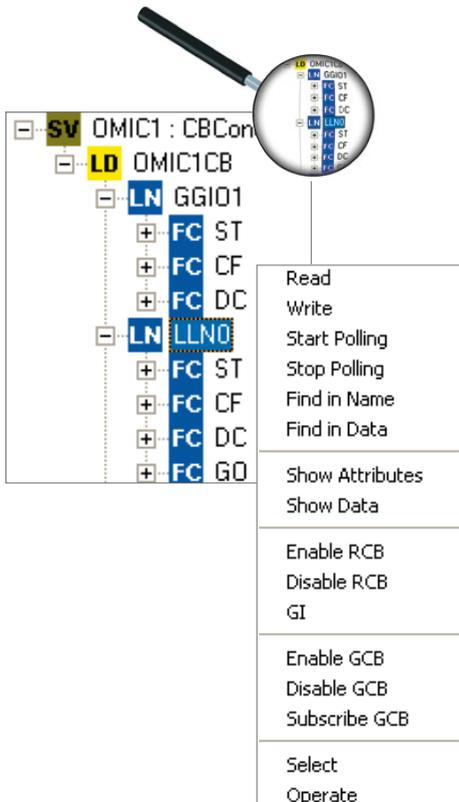
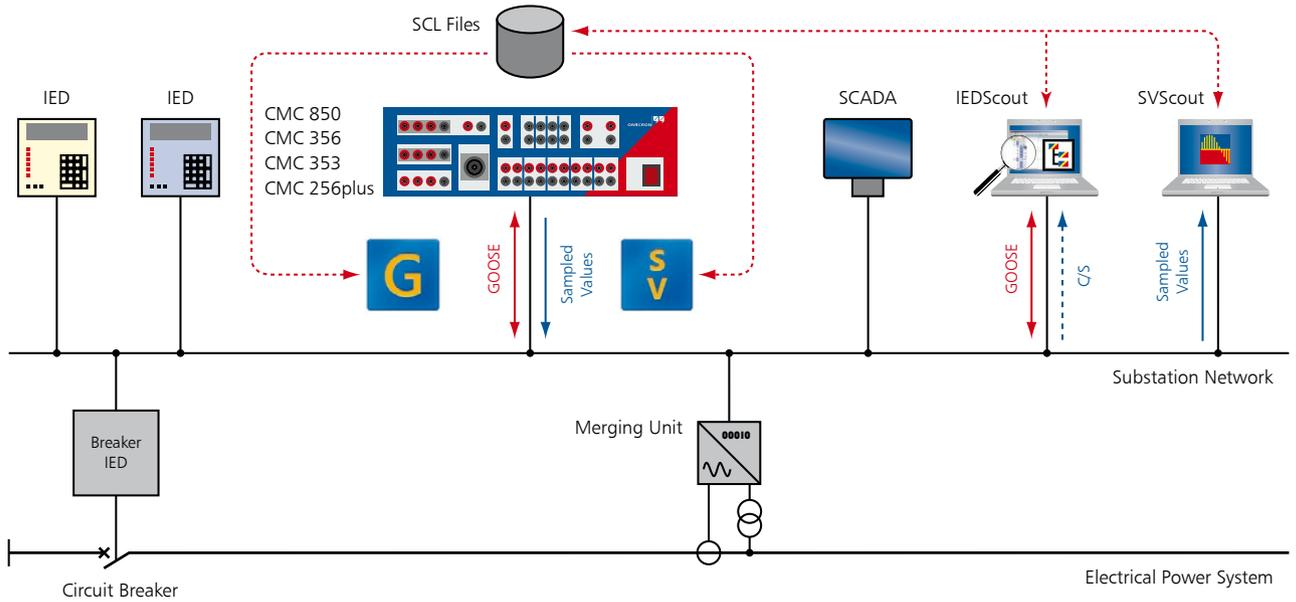

## IEDScout

VESC1500

IEDScout is a software tool for engineers working with IEC 61850 devices. It provides numerous useful functions needed in the substation or the laboratory. With IEDScout, the protection engineer has new options to enhance the depth and quality of testing.

### Applications

IEDScout serves many applications with IEC 61850 devices, among them are:

- > Testing
- > Troubleshooting
- > Commissioning
- > IED Development

### Benefits

- > Provides access to IEC 61850 compatible IEDs from any vendor
- > Can be used even with missing or incomplete configuration information
- > Supports unplanned and improvised testing situations, especially during commissioning and troubleshooting
- > Provides client functionality for developers of IEC 61850 IEDs (servers)
- > Allows creation of SCL files for devices without additional engineering tools

A free evaluation version is available at OMICRON's website (see last page). Please check the IEDScout page for details and download instructions.

<sup>1</sup> The GOOSE and Sampled Values functions are available for CMC 850, CMC 356, CMC 353, CMC 256plus, and CMC 256-6 with any NET-1 hardware option

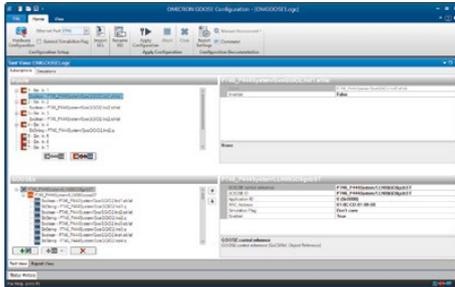

## GOOSE

VESM1181

The GOOSE Configuration module configures the mappings and sets up the CMC test set for communicating with the GOOSE messages on the substation network. As with any OMICRON test module, it can be inserted multiple times in test plans to automatically configure the “wiring”. To facilitate parameter entry and to avoid typing errors, the parameters can be imported from configuration files in the standardized SCL format.

CMC test sets operate with status data in GOOSE messages as if they were “wired” to the binary inputs and outputs of a CMC test set. Data attributes from received (subscribed) GOOSE messages actuate the binary inputs of the test set (for instance trip or start signals). Binary outputs actuate data attributes in simulated (published) GOOSE messages. By this generic approach, all test modules of the OMICRON Test Universe software can be used with GOOSE.

All IEC 61850 types and structures are allowed in a GOOSE dataset. Mappings are provided for Boolean, Bit-String, Enum, Integer, and Unsigned. The timing performance of the message exchange is according to Type 1A; Class P2/3 (IEC 61850-5, “Trip” – “most important fast message”).

## Sampled Values (SV)

VESM1184

The Sampled Values Configuration module is used to set up the generation of up to three<sup>1</sup> Sampled Values streams in the test set. It provides the communication parameters and enables the Sampled Values output. To facilitate parameter entry and to avoid typing errors, the parameters can be imported from configuration files in the standardized SCL format.

CMC test sets generate Sampled Values according to the “Implementation Guideline for Digital Interface to Instrument Transformers using IEC 61850-9-2”, which is published by the UCA International Users Group. As this implementation guideline defines a subset of IEC 61850-9-2, it is commonly referred to with its nickname “9-2 Light Edition” or short “9-2 LE”. The test set generates Sampled Values at a rate of 80 samples per cycle as intended for protection and metering applications. Nominal network frequencies of 50 Hz and 60 Hz are supported.

The published Sampled Values correspond to the analog voltages and currents generated at the voltage and current outputs of the test set. As the secondary values are still available, hybrid applications are supported. The scaling of the primary values represented by the Sampled Values is done with the existing VT and CT settings from the Test Object. By this generic approach, all test modules of the OMICRON Test Universe software can be used with Sampled Values.

## IEC 61850 Package

VESM1185

Since the different testing tasks typically come together, OMICRON has bundled the most common tools in a package. It consists of

- > GOOSE Configuration module
- > Sampled Values Configuration module
- > IEDScout

<sup>1</sup> CMC 850 or CMC 356, CMC 256plus with Option LLO 2: three Sampled Values streams  
 CMC 353, CMC 256-6 or CMC 356, CMC 256plus without Option LLO 2: two Sampled Values streams

# IEC 61850 Testing Tools

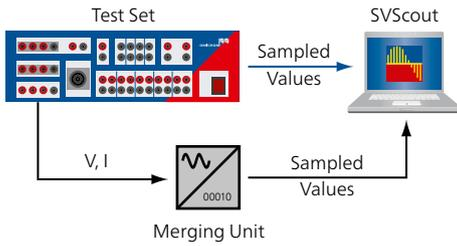

## SVScout

The OMICRON SVScout software makes Sampled Values visible for the substation engineer and IED developer. One important application of SVScout is testing merging units by comparing two SV streams. The accurate measurement of the merging unit's time synchronization is especially useful for developers.

SVScout subscribes to Sampled Values streams from merging units and displays the waveforms of the primary voltages and currents in an oscilloscope view. The data are displayed with their electrical units. Detailed values on the traces can be looked up and compared with each other utilizing the cursor functions. The RMS values and phase angles are calculated from the Sampled Values and displayed in a phasor diagram and a measurement table.

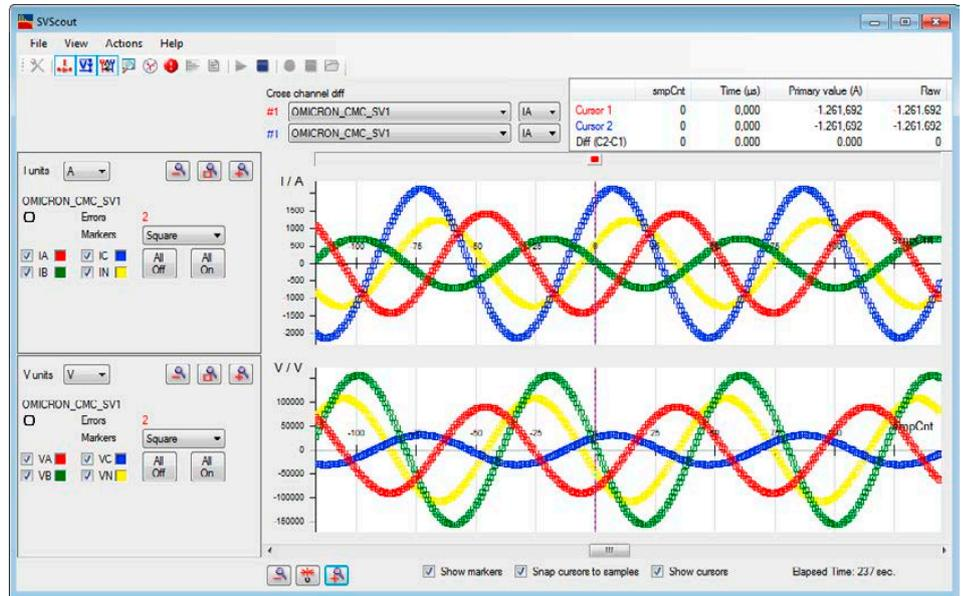

Captured Sampled Values can be saved in COMTRADE files for further in-depth analysis. Expert functions provide even more details on the received data, such as the detailed decoding of the quality codes.

Network traffic saved in PCAP files<sup>1</sup> can be opened in SVScout and analyzed as if it was received online.

When used with a special network adapter, the SVScout can provide accurate details about the time distribution and jitter of the data packets and, when synchronized with the merging unit, also about the propagation delay in the communication network.

## Ordering Information

Order number	Delivery contents
VESC1510	SVScout Standard
VESC1511	SVScout Enhanced (with special network adapter)

<sup>1</sup> File format for saving captured network traffic as produced by many network tools (e.g. Wireshark<sup>®</sup>)

## CMC 850 Package

VE008501



CMC 850: IEC 61850 Test Set

The CMC 850 is OMICRON's protection test set dedicated to IEC 61850. It focuses on the real-time communication methods of GOOSE and Sampled Values to interface with the devices under test. The test set works with the proven Test Universe software and offers even more useful functions embedded directly in the device.

The CMC 850 is part of the CMC 850 Package which comprises optimized hardware and the key software components from the Test Universe software, making it "ready to go" for time synchronized testing with GOOSE and Sampled Values:

Hardware: CMC 850 device and CMIRIG-B interface unit for time synchronization

Software: IEDScout, GOOSE Configuration module, and Sampled Values Configuration module, QuickCMC, State Sequencer, and OMICRON Control Center.

### Embedded Functions

The CMC 850 provides new functions which are accessible through a web interface, simply by using a web browser.

- > Receiving Sampled Values and displaying the data in a Multimeter View and an Oscilloscope View
- > Calculating phasors from the subscribed Sampled Values and providing them via the IEEE C37.118 protocol
- > Synchronizing to network time sources via NTP or PTP V1
- > Playback of network traffic saved in PCAP file format
- > Access to the CMC 850 system information & online help

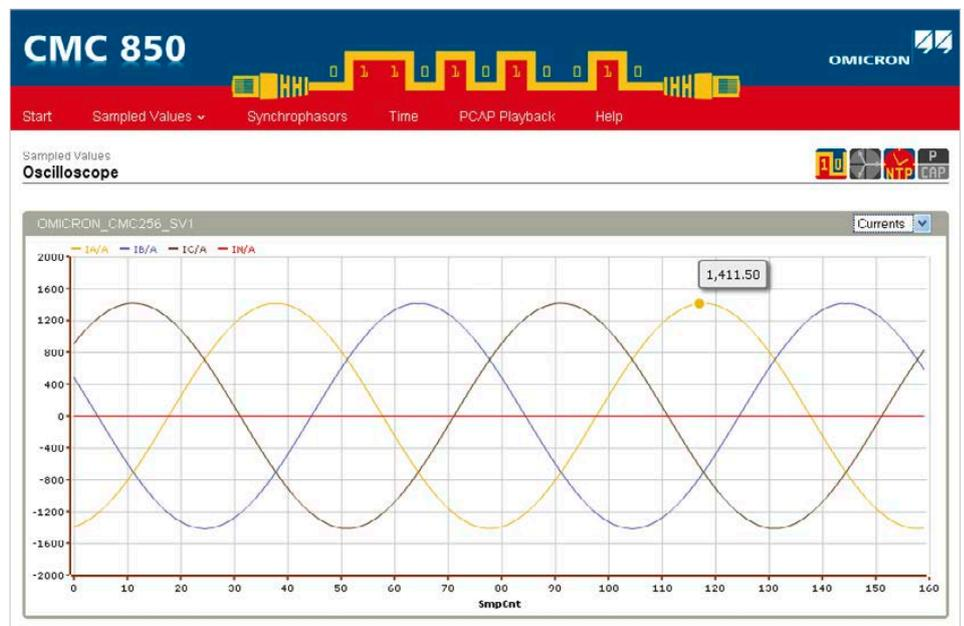

### GOOSE and Sampled Values

For the simulation and subscription of GOOSE up to 360 inputs and outputs are available. The CMC 850 can generate up to three Sampled Values streams.

### Time Synchronization

To perform time synchronized tests with the Test Universe software (e.g. generation of Sampled Values synchronized with IRIG-B or PPS), the OMICRON CMIRIG-B interface unit is provided. The CMC 850 can use NTP (Network Time Protocol) or PTP (Precision Time Protocol, IEEE 1588-2002, V1) to obtain the time for time stamping GOOSE or Synchrophasors.

### Traffic Segregation

Two 10/100 Mbps Ethernet ports allow safe separation of data traffic from different network segments, for example, substation protocol data and test set control commands.

### Compatibility

Test plans containing the GOOSE Configuration and the Sampled Values Configuration module created for other CMC models can be used by the CMC 850 as well.

## Simulation-based Distributed Protection Testing

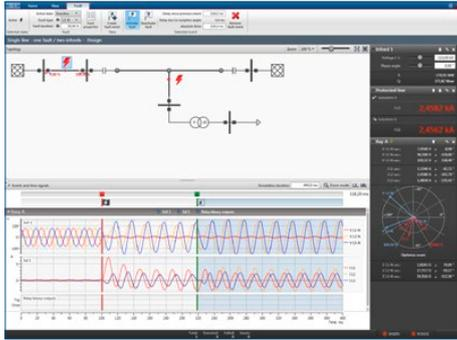

Easy workflow

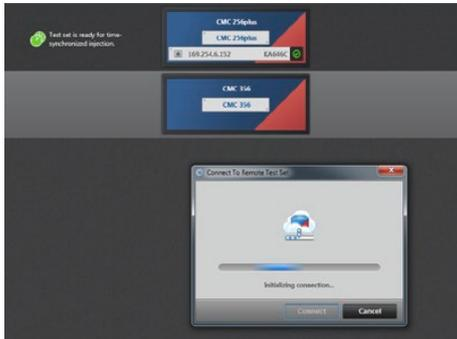

Connection of various CMC test sets via Internet

RelaySimTest is a unique software for simulation based, distributed protection testing in the field using one or more CMC test sets. Its application oriented testing can reveal failures created during calculations or setup of the relay, requiring only a minimum of test steps.

### Distributed testing

With RelaySimTest all connected CMCs for the test are controlled from one PC. Remote CMCs can be controlled via a simple Internet connection. This results in the simplest distributed testing possible for systems such as teleprotection or line differential protection, regardless of how many CMC test sets are used.

In addition, the distributed testing itself is straightforward: RelaySimTest calculates the required injection signals for all ends automatically, making troubleshooting uncomplicated.

### Automatically synchronized

Distributed tests can be performed in the same way as single-end shots, using the CMGPS 588 Grandmaster Clock – our plug-and-play solution – to synchronize the distributed injections.

Furthermore, RelaySimTest simulates relay controlled breaker operations. With this iterative closed-loop simulation the testing of auto-recloser functions is possible – even in distributed protection systems.

### Easy and flexible

Predefined templates enable a fast and easy start for standard testing situations. More complex power networks and fault scenarios are modeled with the flexible grid editor.

Relays can be tested with a single shot or multiple shots can be created with varied parameters (for example, fault type, fault location, etc.). Afterwards all test results can be automatically assessed on a simple time grading of the protected lines.

Even without a CMC connected, RelaySimTest is perfectly capable of simulating steady-state values and transient signals.

### Key features

- > Controlling multiple CMCs from one application via the Internet
- > Application-oriented testing of protection systems
- > Independent from relay type, manufacturer or detailed parameters
- > Testing of advanced relay functions
- > Easy transient simulations

### Supported test equipment

- > CMC 356, CMC 353, CMC 256plus, CMC 256-6<sup>1</sup>, CMC 850
- > CMGPS 588 (required for time-synchronized injection)

### Ordering Information

Order number	Delivery contents
VESM6007	Software RelaySimTest
VESM6009	Package for distributed testings, including two Licenses of RelaySimTest plus two CMGPS 588

<sup>1</sup> With any NET-1 hardware option

## Simulation-based Type and Acceptance Testing

VESM6005



Test view

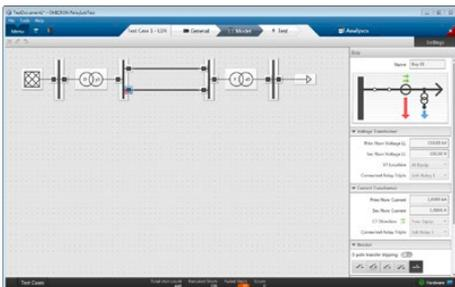

Grid editor



Statistical analyses (for example, SIR diagram)



Histogram results according to IEC 60255-121

RelayLabTest is a unique software which enables the user to assess the overall performance of protection devices under realistic operating conditions. It substantially simplifies in-depth type and acceptance testing on the basis of a network simulation. Test signals are directly output on CMC devices and optional amplifiers. The software is particularly easy to use and requires no special simulation or programming skills.

The setting up and execution of comprehensive tests is very convenient as RelayLabTest offers unique modeling and test automation functions. Any network or fault parameter can be varied automatically thus making this ideal for manufacturers' type testing or acceptance testing undertaken within utilities. Large numbers of test shots are created with just a few mouse-clicks.

Extensive test sequences support the simulation of complex fault scenarios such as cross-country and evolving faults. They include multiple fault incidents and also breaker operations in response to the relay commands. This allows the simulation of auto-reclosure cycles and offers the possibility to perform iterative closed-loop tests of one or more protection relays.

In addition to its flexible automation functionality, RelayLabTest provides in-depth analyses of the test results such as SIR diagrams and trip time histograms. Test results and statistical data can then be easily exported to external applications. RelayLabTest perfectly complies with the requirements for simulation tests according to the forthcoming distance protection standard IEC 60255-121.<sup>1</sup>

### More functions

- > Clearly-structured settings ensure full control of all test parameters. For each element in the network a wide range of options is available.
- > A dashboard displays current, voltage, and power values from different locations. This information can be used to analyze load flows and fault currents.
- > Automated assessment functions facilitate the quick evaluation of individual test shots and the overall test results. Failed shots can be found instantly and re-injected without delay.
- > Test plans combine different network configurations and fault scenarios. Multiple test cases can be executed and analyzed simultaneously.

### Applications

- > Type tests according to IEC 60255-121 or individual requirements
- > Thorough acceptance tests at utilities
- > Investigation of relay algorithm behavior
- > Simulation-based scheme tests
- > Reproduction of real-life scenarios

### Key features

- > Quick and flexible modeling of complex power networks
- > Automatic parameter variation for the quick set up of comprehensive tests
- > User-definable test sequences to simulate complex fault scenarios
- > Simulation of breaker operations for iterative closed-loop testing
- > Easy-to-apply statistical analyses for an in-depth view on test results
- > Current and voltage output on CMC test sets and additional amplifiers
- > IEC 61850 support for testing with GOOSE messages and Sampled Values

### Supported test equipment

- > Test sets: CMC 356, CMC 353, CMC 256plus, CMC 256-6<sup>2</sup>, CMC 850
- > Amplifiers: CMA 156, CMS 156, CMA 56, third-party amplifiers

<sup>1</sup> For all other tests required by IEC 60255-121, OMICRON provides an add-on for the Test Universe software

<sup>2</sup> With any NET-1 hardware option

## CMC 356: 6 Phase Current + 4 Phase Voltage Test Set and Commissioning Tool



The CMC 356 is the universal solution for testing all generations and types of protection relays. Its powerful six current sources (three-phase mode: up to 64 A / 860 VA per channel) with a great dynamic range, make the unit capable of testing even high-burden electromechanical relays with very high power demands. Commissioning engineers will particularly appreciate the possibility to perform wiring and plausibility checks of current transformers, by using primary injection of high currents from the test set. The CMC 356 is the first choice for applications requiring the highest versatility, amplitude and power.

Operation: PC or CMControl

### Technical Data<sup>1</sup>

Current generators			
Setting range	6-phase AC (L-N)	6 x 0 ... 32 A	
	3-phase AC (L-N)	3 x 0 ... 64 A (Group A II B)	
	1-phase AC (LL-LN)	1 x 0 ... 128 A (Group A II B)	
	DC (LL-LN)	1 x 0 ... ±180 A (Group A II B)	
Power <sup>2</sup>	6-phase AC (L-N)	6 x 430 VA typ. at 25 A 6 x 250 W guar. at 20 A	
	3-phase AC (L-N)	3 x 860 VA typ. at 50 A 3 x 500 W guar. at 40 A	
	1-phase AC (LL-LN)	1 x 1000 VA typ. at 80 A 1 x 700 W guar. at 80 A	
	1-phase AC (L-L)	1 x 1740 VA typ. at 50 A 1 x 1100 W guar. at 40 A	
	1-phase AC (L-L-L)	1 x 1740 VA typ. at 25 A 1 x 1100 W guar. at 20 A	
	DC (LL-LN)	1 x 1400 W typ. at ±80 A 1 x 1000 W guar. at ±80 A	
	Accuracy <sup>3</sup>	Error < 0.05 % rd. <sup>4</sup> + 0.02 % rg. <sup>4</sup> typ. Error < 0.15 % rd. + 0.05 % rg. guar.	
Distortion (THD+N) <sup>5</sup>	< 0.05 % typ., < 0.15 % guar.		
Resolution	1 mA		
Max. compliance voltage (L-N)/(L-L)/(L-L-L)	35 Vpk / 70 Vpk / 140 Vpk		
Connection banana sockets	4 mm (0.16 in) banana sockets (32 A continuously)		
Connection combination socket	Group A only (25 A continuously max.)		

Voltage generators			
Setting range	4-phase AC (L-N)	4 x 0 ... 300 V (VL4(t) automatically calculated: VL4 = (VL1+VL2+VL3)*c or freely programmable)	
	3-phase AC (L-N)	3 x 0 ... 300 V	
	1-phase AC (L-L)	1 x 0 ... 600 V	
	DC (L-N)	4 x 0 ... ±300 V	
Power	3-phase AC (L-N)	3 x 100 VA typ. at 100 ... 300 V 3 x 85 VA guar. at 85 ... 300 V	
	4-phase AC (L-N)	4 x 75 VA typ. at 100 ... 300 V 4 x 50 VA guar. at 85 ... 300 V	
	1-phase AC (L-N)	1 x 200 VA typ. at 100 ... 300 V 1 x 150 VA guar. at 75 ... 300 V	
	1-phase AC (L-L)	1 x 275 VA typ. at 200 ... 600 V 1 x 250 VA guar. at 200 ... 600 V	
	DC (L-N)	1 x 420 W typ. at ±300 V 1 x 360 W guar. at ±300 V	
	Accuracy	Error < 0.03 % rd. <sup>4</sup> + 0.01 % rg. <sup>4</sup> typ. at 0 ... 300 V Error < 0.08 % rd. + 0.02 % rg. guar. at 0 ... 300 V	
Distortion (THD+N) <sup>5</sup>	0.015 % typ., < 0.05 % guar.		
Ranges	150 V / 300 V		
Resolution	5 mV / 10 mV in range 150 V / 300 V		
Connection	4 mm (0.16 in) banana sockets / combination socket (1,2,3,N)		
Generators, general			
Frequency	Range sine signals <sup>6</sup>	10 ... 1000 Hz	
	Range harmonics / interharmonics	Voltage: 10 ... 3000 Hz <sup>7</sup> Current: 10 ... 1000 Hz	
	Range transient signals	DC ... 3.1 kHz <sup>7</sup>	
	Accuracy / drift	±0.5 ppm / ±1 ppm	
	Resolution	< 5 µHz	
Phase	Angle range	-360° ... +360°	
	Resolution	0.001°	
	Error at 50 / 60 Hz	Voltage: 0.02° typ., < 0.1° guar. Current: 0.05° typ., < 0.2° guar. <sup>3</sup>	
Bandwidth (-3 dB)	3.1 kHz		

<sup>1</sup> All data specified are guaranteed, except where indicated otherwise. OMICRON guarantees the specified data for one year after factory calibration, within 23 °C ±5 °C (73 °F ±10 °F) in the frequency range from 10 to 100 Hz and after a warm-up phase > 25 minutes

<sup>2</sup> Typical AC values valid for inductive loads (e.g. e/m relays)

<sup>3</sup> Rload: 0 ... 0.5 Ω

<sup>4</sup> rd. = reading, rg. = range

<sup>5</sup> THD+N: Values at 50/60 Hz, > 1 A / 20 V with 20 kHz bandwidth

<sup>6</sup> For current outputs amplitude derating at > 380 Hz

<sup>7</sup> Amplitude derating at > 1000 Hz

Low level outputs <sup>1</sup>	
Number of outputs	6 (12 with Option LLO-2)
Setting range	0 ... ±10 Vpk
Max. output current	1 mA
Accuracy	error < 0.025 % typ., < 0.07 % guar.at 1 ... 10 Vpk
Resolution	250 µV
Distortion (THD+N) <sup>2</sup>	< 0.015 % typ., < 0.05 % guar.
Unconventional CT/VT simulation	linear, Rogowski (transient and sinewave)
Overload indication	yes
Isolation	SELV
Usability	completely independent from internal amplifier outputs
Connection	16 pin combination socket (rear side)
Auxiliary DC supply	
Voltage ranges	0 ... 264 VDC, 0.2 A / 0 ... 132 VDC, 0.4 A / 0 ... 66 VDC, 0.8 A
Power	max. 50 W
Accuracy	error < 2 % typ., < 5 % guar
Binary inputs	
Number	10
Trigger criteria	Toggling of potential-free contacts or DC voltage compared to threshold voltage
Input characteristics	0 ... ±300 VDC threshold or potential-free If equipped with ELT-1 <sup>3</sup> : 0 ... ±600 VDC threshold or potential-free
Ranges	20 V / 300 V If equipped with ELT-1 <sup>3</sup> : 100 mV / 1 V / 10 V / 100 V / 600 V
Resolution of threshold	50 mV (0 ... 20 V), 500 mV (20 V ... 300 V) ELT-1 <sup>3</sup> : ±2 mV, ±20 mV, ±200 mV, ±2 V, ±20 V in ranges
Sample rate	10 kHz (resolution 100 µs)
Time stamping accuracy	±0.00015 % of rd. <sup>5</sup> ±70 µs
Max. measuring time	infinite
Debounce / Deglitch time	0 ... 25 ms / 0 ... 25 ms
Counting function	< 3 kHz at pulse width > 150 µs
Galvanic isolation	5 galvanically isolated groups (2+2+2+2)
Max. input voltage	CAT IV / 150 V, CAT III / 300 V, transient immunity 2 kV If equipped with ELT-1 <sup>3</sup> : CAT IV / 150 V, CAT III / 300 V, CAT II / 600 V (850 Vpk)
Counter inputs 100 kHz	
Number	2
Max. counting frequency	100 kHz
Pulse width	> 3 µs
Threshold voltage	6 V
Voltage hysteresis	2 V
Max. input voltage	±30 V
Isolation	SELV
Connection	16 pin combination socket (rear side)
Trigger on overload	
Supported generators	Current generators
Timer accuracy	error < 1 ms

<sup>1</sup> For directly testing relays with low level inputs by simulating signals from non conventional CTs and VTs with low level interfaces and for controlling external amplifier units

<sup>2</sup> THD+N: Values at 50/60 Hz, 20 kHz measurement bandwidth, nominal value, and nominal load

<sup>3</sup> The ELT-1 hardware option turns the ten binary inputs into multifunctional analog AC and DC voltage measuring inputs and adds two DC measuring inputs (0 ... 10 V / 0 ... 20 mA) for transducer testing

<sup>4</sup> Up to three inputs can be used for measuring RMS values, frequency, and phase angle without the EnerLyzer software license. Full functionality requires EnerLyzer software license

<sup>5</sup> rd. = reading, rg. = range

Binary outputs, relays	
Type	Potential-free relay contacts, software controlled
Number	4
Break capacity AC	Vmax: 300 VAC / Imax: 8 A / Pmax: 2000 VA
Break capacity DC	Vmax: 300 VDC / Imax: 8 A / Pmax: 50 W
Binary outputs, transistor	
Type	Open collector transistor outputs
Number	4
Update rate	10 kHz
I <sub>max</sub>	5 mA
Connection	16 pin combination socket (rear side)
DC voltage measuring input (If option ELT-1 is equipped <sup>3</sup> )	
Measuring range	0 ... ±10 V
Accuracy	Error < 0.003 % rg. <sup>5</sup> typ., < 0.02 % rg. guar.
Input impedance	1 MΩ
DC current measuring input (If option ELT-1 is equipped <sup>3</sup> )	
Measuring range	0 ... ±1 mA, 0 ... ±20 mA
Accuracy	Error < 0.003 % rg. <sup>5</sup> typ., < 0.02 % rg. guar.
Input impedance	15 Ω
Analog AC+DC measuring inputs (If option ELT-1 is equipped <sup>3,4</sup> )	
Type	AC + DC analog voltage inputs (current measurement with external current clamps or shunt resistors)
Number	10
Nominal input ranges (RMS values)	100 mV, 1 V, 10 V, 100 V, 600 V
Amplitude accuracy	Error < 0.06 % typ., < 0.15 % guar.
Bandwidth	DC ... 10 kHz
Sampling frequency	28.44 kHz, 9.48 kHz, 3.16 kHz
Input impedance	500 kΩ // 50 pF
Transient input buffer at 28 kHz	3.5 s for 10 input channels 35 s for 1 input channel
Transient input buffer at 3 kHz	31 s for 10 input channels 5 min. for 1 input channel
Transient trigger	Threshold voltage, power quality trigger: sag, swell, harmonic, frequency, frequency change, notch
Measurement functions	I (AC + DC), V (AC + DC), phase, frequency, power, harmonics, transient-, event- and trend recording
Input overload indication	Yes
Input protection	Yes
Max. input voltage	CAT IV / 150 V, CAT III / 300 V, CAT II / 600 V (850 Vpk)
Galvanic isolation	5 groups (2+2+2+2)
Time synchronization	
Timing accuracy (voltage/current)	IRIG-B synchronization with CMIRIG-B GPS synchronization with CMGPS 588
To external voltage	Error < 1/5 µs typ., < 5/20 µs guar. Error < 1/5 µs typ., < 5/20 µs guar.
Precision Time Protocol (PTP)	Reference signal on binary input 10: 15 ... 70 Hz IEEE 1588-2008 IEEE C37.238-2011 (Power Profile)

With the unique PermaSync functionality, analog and Sampled Values outputs stay permanently in sync with the internal CMC time reference.  
When a CMC is time-synchronized (IRIG-B, GPS, or PTP), the output quantities are continuously synchronized to the external time source.  
With CMIRIG-B it is also possible to transmit the internal PPS signal of the CMC to the device under test (e.g. PMUs or IEDs stimulated with a synchronized Sampled Values data stream).

## Technical Data CMC 356 (continued)

IEC 61850 GOOSE <sup>1</sup>	
Simulation	Mapping of binary outputs to data attributes in published GOOSE messages. Number of virtual binary outputs: 360 Number of GOOSEs to be published: 128
Subscription	Mapping of data attributes from subscribed GOOSE messages to binary inputs. Number of virtual binary inputs: 360 Number of GOOSEs to be subscribed: 128
Performance	Type 1A; Class P2/3 (IEC 61850-5). Processing time (application to network or vice versa): < 1 ms
VLAN support	Selectable priority and VLAN-ID
IEC 61850 Sampled Values (Publishing) <sup>1</sup>	
Specification	According to the "Implementation Guideline for Digital Interface to Instrument Transformers Using IEC 61850-9-2" of the ICA International Users Group
Sampling Rate	80 samples per cycle for nominal frequencies of 50 Hz and 60 Hz.
Synchronization	Synchronization attribute (smpSynch) is set when the CMC is in synchronized operation mode. Sample count (smpCnt) zero is aligned with top of the second. Accuracy data see above
VLAN support	Selectable priority and VLAN-ID
Max. number of SV streams	2 (with option LLO-2: 3 SV streams)
Power supply	
Nominal input voltage <sup>2</sup>	100 – 240 VAC, 1-phase
Permissible input voltage	85 ... 264 VAC
Nominal frequency	50/60 Hz
Permissible frequency range	45 ... 65 Hz
Rated current	12 A at 115 V / 10 A at 230 V
Connection	Standard AC socket (IEC 60320)
Environmental conditions	
Operation temperature <sup>3</sup>	0 ... +50 °C (+32 ... +122 °F)
Storage temperature	-25 ... +70 °C (-13 ... +158 °F)
Humidity range	Relative humidity 5 ... 95 %, non-condensing
Vibration	IEC 60068-2-6 (20 m/s <sup>2</sup> at 10 ... 150 Hz)
Shock	IEC 60068-2-27 (15 g/11 ms half-sine)
Safety standards, electromagnetic compatibility	
EMC	The product adheres to the electromagnetic compatibility (EMC) Directive 2004/108/EC (CE conform). International USA IEC 61326-1; IEC 61000-6-4; IEC 61000-3-2/3 FCC Subpart B of Part 15 Class A
Safety	The product adheres to the low voltage Directive 2006/95/EC (CE conform). International / USA Canada IEC 61010-1 / UL 61010-1 CAN/CSA-C22.2 No 61010-1-04

Miscellaneous	
Weight	16.8 kg (37.0 lbs)
Dimensions (W x H x D, without handle)	450 x 145 x 390 mm (17.7 x 5.7 x 15.4 in)
PC connection	Two PoE <sup>4</sup> Ethernet ports: <ul style="list-style-type: none"> <li>10/100 Mbit/s (10/100 Base-TX, auto-crossover)</li> <li>IEEE 802.3af compliant</li> <li>Port capability limited to one Class 1 (3.84 W) and one Class 2 (6.49 W) powered device</li> </ul> USB 2.0 port: <ul style="list-style-type: none"> <li>Full speed (Type B connector)</li> </ul>
Signal indication (LED)	> 42 V for voltage and current outputs and AUX DC
Connection to ground (earth)	4 mm (0.16 in) banana socket (rear side)
Hardware diagnostics	Self diagnostics upon each start-up
Galvanically separated groups	The following groups are galvanically separated from each other: mains, voltage amplifier output, current amplifier group A/B, auxiliary DC supply, binary/analog input
Protection	All current and voltage outputs are fully overload and short circuit proof and protected against external high-voltage transient signals and over temperature
Certifications	
 	
Developed and manufactured under an ISO 9001 registered system	

## Ordering Information

CMC 356 with Test Universe software	
VE002801	CMC 356 Basic
VE002802	CMC 356 Protection
VE002803	CMC 356 Advanced Protection
VE002825	CMC 356 Recloser

CMC 356 with CMControl (without Test Universe software)	
VE002820	CMC 356 with CMControl P
VE002824	CMC 356 with CMControl R
VE002826	CMC 356 with CMControl P App activation key

The CMControl can also be ordered as add-on together with a CMC 356 with Test Universe software or as a later upgrade.

CMC 356 hardware options	
VEHO2801	Option ELT-1 if ordered with a new unit
VEHO2802	Option ELT-1 if ordered as an upgrade
VEHO2803	Option LLO-2 if ordered with a new unit
VEHO2804	Option LLO-2 if ordered as an upgrade

<sup>1</sup> The GOOSE and Sampled Values functionality require software licences for the respective configuration modules

<sup>2</sup> For line input voltages below 230 V, a derating of the simultaneously available sum output power of the voltage/current amplifiers and the AuxDC will occur. All other technical specifications (e.g. the maximum output power of a single amplifier) are not affected.

<sup>3</sup> For an operational temperature above +30 °C (+86 °F) a duty cycle of down to 50 % may apply.

<sup>4</sup> PoE = Power over Ethernet

## CMC 256plus: 6 Phase Current + 4 Phase Voltage Test Set and Universal Calibrator



The CMC 256plus is the first choice for applications requiring very high accuracy. This unit is not only an excellent test set for protection devices of all kinds but also a universal calibration tool. Its high precision allows the calibration of a wide range of measuring devices, including: electricity meters of class 0.2S, measuring transducers, power quality measurement devices and phasor measurement units (PMU). Its unique accuracy and flexibility make the CMC 256plus ideal for protection and measurement equipment manufacturers for research and development, production and type testing.

Operation: PC or CMControl

### Technical Data<sup>1</sup>

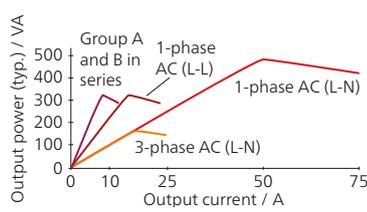
Current generators		
Setting	6-phase AC (L-N)	6 x 0 ... 12.5 A
range	3-phase AC (L-N)	3 x 0 ... 25 A (Group A II B)
	1-phase AC (3L-N)	1 x 0 ... 75 A (Group A II B), 2 x 0 ... 37.5 A
Power	DC (3L-N)	1 x 0 ... ±35 A (Group A II B), 2 x 0 ... ±17.5 A
	6-phase AC (L-N)	6 x 80 VA typ. at 8.5 A, 6 x 70 VA guar. at 7.5 A
	3-phase AC (L-N)	3 x 160 VA typ. at 17 A (Group A II B) 3 x 140 VA guar. at 15 A (Group A II B)
	1-phase AC (3L-N)	1 x 480 VA typ. at 51 A (Group A II B), 2 x 240 VA at 25.5 A 1 x 420 VA guar. at 45 A (Group A II B), 2 x 210 VA at 22.5 A
	1-phase AC (L-L)	1 x 320 VA typ. at 8.5 A (Group A II B), 2 x 160 VA at 8.5 A 1 x 280 VA guar. at 15 A (Group A II B), 2 x 140 VA at 7.5 A
	1-phase AC (L-L-L-L)	1 x 320 VA typ. at 8.5 A (40 VRMS, Group A and B in series) 1 x 280 VA guar. at 7.5 A (40 VRMS, Group A and B in series)
	DC (3L-N)	1 x 480 W typ. at ±35 A (Group A II B), 2 x 240 W at ±17.5 A 1 x 470 W guar. at ±35 A (Group A II B), 2 x 235 W at ±17.5 A
		
Accuracy <sup>2</sup>	error < 0.015 % rd. <sup>3</sup> + 0.005 % rg. <sup>3</sup> typ. at 0 ... 12.5 A error < 0.04 % rd. + 0.01 % rg. guar. at 0 ... 12.5 A	
Distortion (THD+N) <sup>4</sup>	< 0.025 % typ., < 0.07 % guar.	
Ranges	1.25 A / 12.5 A (Group A, B) or 2.5 A / 25 A (Group A II B)	
Resolution (for respective range)	50 µA / 100 µA / 500 µA / 1 mA	
Max. compliance voltage (L-N)/(L-L)	15 Vpk / 60 Vpk	
Connection	4 mm (0.16 in) banana sockets / combination socket (Group A only)	

<sup>1</sup> All data specified are guaranteed, except where indicated otherwise. OMICRON guarantees the specified data for one year after factory calibration, within 23 °C ± 5 °C (73 °F ± 10 °F) in the frequency range from 10 to 100 Hz and after a warm-up phase > 25 minutes

<sup>2</sup> Load: 0 ... 0.5 Ω

<sup>3</sup> rd. = reading, rg. = range

<sup>4</sup> THD+N: Values at 50/60 Hz, > 1 A / 20 V with 20 kHz bandwidth

<sup>5</sup> Load: > 250 Ω

<sup>6</sup> Amplitude derating at > 1000 Hz

<sup>7</sup> Data are valid from 0.1 to 12.5 A (current amplifier A or B) and 50 to 300 V (voltage amplifier) at 50/60 Hz

Permissible load for current outputs:

Range 1.25 A: 0 to 1 Ω and 1 VA max., cos φ = 0.5 to 1

Range 12.5 A: 0 to 0.5 Ω and 6 VA max., cos φ = 0.5 to 1

Permissible load for voltage outputs:

10 VA max. at 50 to 300 V, cos φ = 0.5 to 1

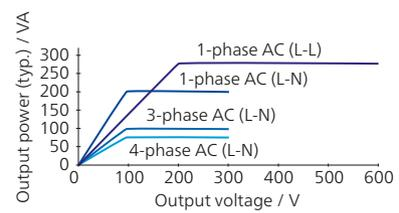
Voltage generators		
Setting range	4-phase AC (L-N)	4 x 0 ... 300 V (VL4(t) automatically calculated: VL4 = (VL1+VL2+VL3)*c or freely programmable)
	3-phase AC (L-N)	3 x 0 ... 300 V
	1-phase AC (L-L)	1 x 0 ... 600 V
	DC (L-N)	4 x 0 ... ±300 V
Power	3-phase AC (L-N)	3 x 100 VA typ. at 100 ... 300 V 3 x 85 VA guar. at 85 ... 300 V
	4-phase AC (L-N)	4 x 75 VA typ. at 100 ... 300 V 4 x 50 VA guar. at 85 ... 300 V
	1-phase AC (L-N)	1 x 200 VA typ. at 100 ... 300 V 1 x 150 VA guar. at 75 ... 300 V
	1-phase AC (L-L)	1 x 275 VA typ. at 200 ... 600 V 1 x 250 VA guar. at 200 ... 600 V
	DC (L-N)	1 x 420 W typ. at ±300 V 1 x 360 W guar. at ±300 V
		
Accuracy <sup>5</sup>	Error < 0.015 % rd. <sup>3</sup> + 0.005 % rg. <sup>3</sup> typ. at 0 ... 300 V Error < 0.04 % rd. + 0.01 % rg. guar. at 0 ... 300 V	
Distortion (THD+N) <sup>4</sup>	0.015 % typ., < 0.05 % guar.	
Ranges	150 V / 300 V	
Resolution	5 mV / 10 mV in range 150 V / 300 V	
Connection	4 mm (0.16 in) banana sockets / combination socket (1,2,3,N)	
Generators, general		
Frequency	Range sine signals	10 ... 1000 Hz
	Range harmonics / interharmonics <sup>6</sup>	10 ... 3000 Hz
	Range transient signals <sup>6</sup>	DC ... 3.1 kHz
	Accuracy / drift	±0.5 ppm / ±1 ppm
	Resolution	< 5 µHz
Phase	Angle range	-360° ... +360°
	Resolution	0.001°
	Error at 50 / 60 Hz	< 0.005° typ., < 0.02° guar.
Bandwidth (-3 dB)	3.1 kHz	
Simulated power S, P (calibration of energy meters)	Accuracy <sup>7</sup>	Error < 0.05 % rd. typ., < 0.1 % rd. guar.
	Temperature drift	< 0.001 % / °C typ., < 0.005 % / °C guar.

## Technical Data CMC 256plus (continued)

Low level outputs <sup>1</sup>	
Number of outputs	6 (12 with Option LLO-2)
Setting range	0 ... ±10 Vpk
Max. output current	1 mA
Accuracy	Error < 0.025 % typ., < 0.07 % guar. at 1 ... 10 Vpk
Resolution	250 µV
Distortion (THD+N) <sup>2</sup>	< 0.015 % typ., < 0.05 % guar.
Unconventional CT/VT simulation	linear, Rogowski (transient and sinewave)
Overload indication	Yes
Isolation	SELV
Usability	Completely independent from internal amplifier outputs
Connection	16 pin combination socket (rear side)
Auxiliary DC supply	
Voltage ranges	0 ... 264 VDC, 0.2 A / 0 ... 132 VDC, 0.4 A / 0 ... 66 VDC, 0.8 A
Power	Max. 50 W
Accuracy	Error < 2 % typ., < 5 % guar.
Binary inputs	
Number	10
Trigger criteria	Toggle of potential-free contacts or DC voltage compared to threshold voltage
Input characteristics	0 ... ±600 VDC threshold or potential-free
Ranges	100 mV / 1 V / 10 V / 100 V / 600 V
Resolution of threshold	±2 mV, ±20 mV, ±200 mV, ±2 V, ±20 V in ranges
Sample rate	10 kHz (resolution 100 µs)
Time stamping accuracy	±0.00015 % of rd. <sup>3</sup> ±70 µs
Max. measuring time	Infinite
Debounce / Deglitch time	0 ... 25 ms / 0 ... 25 ms
Counting function	< 3 kHz at pulse width > 150 µs
Galvanic isolation	5 galvanically isolated groups (2+2+2+2)
Max. input voltage	CAT IV / 150 V, CAT III / 300 V, CAT II / 600 V (850 Vpk)
Counter inputs 100 kHz	
Number	2
Max. counting frequency	100 kHz
Pulse width	> 3 µs
Threshold voltage	6 V
Voltage hysteresis	2 V
Max. input voltage	±30 V
Isolation	SELV
Connection	16 pin combination socket (rear side)
Trigger on overload	
Supported generators	Current generators
Timer accuracy	Error < 1 ms
Binary outputs, relays	
Type	Potential-free relay contacts, software controlled
Number	4
Break capacity AC	Vmax: 300 VAC / Imax: 8 A / Pmax: 2000 VA
Break capacity DC	Vmax: 300 VDC / Imax: 8 A / Pmax: 50 W

Binary outputs, transistor	
Type	Open collector transistor outputs
Number	4
Update rate	10 kHz
Imax	5 mA
Connection	16 pin combination socket (rear side)
DC voltage measuring input	
Measuring range	0 ... ±10 V
Accuracy	Error < 0.003 % rg. <sup>3</sup> typ., < 0.02 % rg. guar.
Input impedance	1 MΩ
DC current measuring input	
Measuring range	0 ... ±1 mA, 0 ... ±20 mA
Accuracy	Error < 0.003 % rg. <sup>3</sup> typ., < 0.02 % rg. guar.
Input impedance	15 Ω
Analog AC+DC measuring inputs <sup>4</sup>	
Type	AC + DC analog voltage inputs (current measurement with external current clamps or shunt resistors)
Number	10
Nominal input ranges (RMS values)	100 mV, 1 V, 10 V, 100 V, 600 V
Amplitude accuracy	Error < 0.06 % typ., < 0.15 % guar.
Bandwidth	DC ... 10 kHz
Sampling frequency	28.44 kHz, 9.48 kHz, 3.16 kHz
Input impedance	500 kΩ // 50 pF
Transient input buffer at 28 kHz	3.5 s for 10 input channels / 35 s for 1 input channel
Transient input buffer at 3 kHz	31 s for 10 input channels / 5 min. for 1 input channel
Transient trigger	Threshold voltage, power quality trigger: sag, swell, harmonic, frequency, frequency change, notch
Measurement functions	I (AC + DC), V (AC + DC), phase, frequency, power, harmonics, transient recording, event recording, trend recording
Input overload indication	Yes
Input protection	Yes
Max. input voltage	CAT IV / 150 V, CAT III / 300 V, CAT II / 600 V (850 Vpk)
Galvanic isolation	5 groups (2+2+2+2)
Time synchronization	
Timing accuracy	IRIG-B synchronization with CMIRIG-B GPS synchronization with CMGPS 588
To external voltage	Error < 1 µs typ., < 5 µs guar. Error < 1 µs typ., < 5 µs guar.
Precision Time Protocol (PTP)	Reference signal on binary input 10: 10 ... 300 V / 15 ... 70 Hz IEEE 1588-2008 IEEE C37.238-2011 (Power Profile)

With the unique PermaSync functionality, analog and Sampled Values outputs stay permanently in sync with the internal CMC time reference. When a CMC is time-synchronized (IRIG-B, GPS, or PTP), the output quantities are continuously synchronized to the external time source. With CMIRIG-B it is also possible to transmit the internal PPS signal of the CMC to the device under test (e.g. PMUs or IEDs stimulated with a synchronized Sampled Values data stream).

<sup>1</sup> For directly testing relays with low level inputs by simulating signals from non conventional CTs and VTs with low level interfaces and for controlling external amplifier units

<sup>2</sup> THD+N: Values at 50/60 Hz, 20 kHz measurement bandwidth, nominal value, and nominal load

<sup>3</sup> rd. = reading, rg. = range

<sup>4</sup> Up to three inputs can be used for measuring RMS values, frequency, and phase angle without the EnerLyzer software license. Full functionality requires EnerLyzer software license

IEC 61850 GOOSE <sup>1</sup>	
Simulation	Mapping of binary outputs to data attributes in published GOOSE messages. Number of virtual binary outputs: 360 Number of GOOSEs to be published: 128
Subscription	Mapping of data attributes from subscribed GOOSE messages to binary inputs. Number of virtual binary inputs: 360 Number of GOOSEs to be subscribed: 128
Performance	Type 1A; Class P2/3 (IEC 61850-5). Processing time (application to network or vice versa): < 1 ms
VLAN support	Selectable priority and VLAN-ID
IEC 61850 Sampled Values (Publishing) <sup>1</sup>	
Specification	According to the "Implementation Guideline for Digital Interface to Instrument Transformers Using IEC 61850-9-2" of the IEC International Users Group
Sampling Rate	80 samples per cycle for nominal frequencies of 50 Hz and 60 Hz.
Synchronization	Synchronization attribute (smpSynch) is set when the CMC is in synchronized operation mode. Sample count (smpCnt) zero is aligned with top of the second. Accuracy data see above
VLAN support	Selectable priority and VLAN-ID
Max. number of SV streams	2 (with option LLO-2: 3 SV streams)
Power supply	
Nominal input voltage <sup>2</sup>	100 – 240 VAC, 1-phase
Permissible input voltage	85 ... 264 VAC
Nominal frequency	50/60 Hz
Permissible frequency range	45 ... 65 Hz
Rated current	12 A at 115 V / 10 A at 230 V
Connection	Standard AC socket (IEC 60320)
Environmental conditions	
Operation temperature <sup>3</sup>	0 ... +50 °C (+32 ... +122 °F)
Storage temperature	-25 ... +70 °C (-13 ... +158 °F)
Humidity range	Relative humidity 5 ... 95 %, non-condensing
Vibration	IEC 60068-2-6 (20 m/s <sup>2</sup> at 10 ... 150 Hz)
Shock	IEC 60068-2-27 (15 g/11 ms half-sine)
Safety standards, electromagnetic compatibility	
EMC	The product adheres to the electromagnetic compatibility (EMC) Directive 2004/108/EC (CE conform). International IEC 61326-1; IEC 61000-6-4; IEC 61000-3-2/3 USA FCC Subpart B of Part 15 Class A
Safety	The product adheres to the low voltage Directive 2006/95/EC (CE conform). International / USA IEC 61010-1 / UL 61010-1 Canada CAN/CSA-C22.2 No 61010-1-04

Miscellaneous	
Weight	16.0 kg (35.3 lbs)
Dimensions (W x H x D, without handle)	450 x 145 x 390 mm (17.7 x 5.7 x 15.4 in)
PC connection	Two PoE <sup>4</sup> Ethernet ports: <ul style="list-style-type: none"> <li>• 10/100 Mbit/s (10/100 Base-TX, auto-crossover)</li> <li>• IEEE 802.3af compliant</li> <li>• Port capability limited to one Class 1 (3.84 W) and one Class 2 (6.49 W) powered device</li> </ul> USB 2.0 port: <ul style="list-style-type: none"> <li>• Full speed (Type B connector)</li> </ul>
Signal indication (LED)	> 42 V for voltage outputs and AUX DC
Connection to ground (earth)	4 mm (0.16 in) banana socket (rear side)
Hardware diagnostics	Self diagnostics upon each start-up
Galvanically separated groups	The following groups are galvanically separated from each other: mains, voltage amplifier output, current amplifier group A/B, auxiliary DC supply, binary/analog input
Protection	All current and voltage outputs are fully overload and short circuit proof and protected against external high-voltage transient signals and over temperature
Certifications	
 	
Developed and manufactured under an ISO 9001 registered system	

## Ordering Information

CMC 256plus with Test Universe software	
VE002701	CMC 256plus Basic
VE002702	CMC 256plus Protection
VE002703	CMC 256plus Advanced Protection
VE002704	CMC 256plus Universal
VE002705	CMC 256plus Meter
VE002706	CMC 256plus Measurement
VE002720	CMC 256plus Recloser

CMC 256plus with CMControl (without Test Universe software)	
VE002715	CMC 256plus with CMControl P
VE002719	CMC 256plus with CMControl R
VE002721	CMC 256plus with CMControl P App activation key

The CMControl can also be ordered as add-on together with a CMC 256plus with Test Universe software or as a later upgrade.

CMC 256plus hardware options	
VEHO2703	Option LLO-2 if ordered with a new unit
VEHO2704	Option LLO-2 if ordered as an upgrade

<sup>1</sup> Testing with GOOSE and Sampled Values functionality requires software licences for the corresponding configuration modules

<sup>2</sup> For line inputs below 115 VAC, it is not possible to drive all outputs (voltage output, current output, Aux DC) simultaneously at full load. All other technical specifications (e.g. the maximum output power of a single amplifier) are not affected

<sup>3</sup> For an operational temperature above +30 °C (+86 °F) a duty cycle of down to 50 % may apply

<sup>4</sup> PoE = Power over Ethernet

## CMC 353: 3 Phase Current + 4 Phase Voltage Test Set and Commissioning Tool



With its compact design and low weight of 13.3 kg / 29.3 lbs, the CMC 353 provides the perfect combination of portability and power. It is the ideal test set for three-phase protection testing and the commissioning of SCADA systems. The powerful current outputs (3 x 32 A / 430 VA) support 5 A relay testing in an optimal way. The portable design makes this device an excellent choice for commissioning and maintenance tasks, particularly in industry, distributed generation, and medium and low voltage applications. It meets a wide variety of challenges in protection engineering – from testing electromechanical relays to the latest IEC 61850 IEDs. Operation: PC or CMControl

### Technical Data<sup>1</sup>

Current generators		
Setting range	3-phase AC (L-N)	3 x 0 ... 32 A
	1-phase AC (L-L)	1 x 0 ... 32 A
	1-phase AC (LL-LN)	1 x 0 ... 64 A
	DC (LL-LN)	1 x 0 ... ±90 A
Power <sup>2,3</sup>	3-phase AC (L-N)	3 x 430 VA typ. at 25 A 3 x 250 W guar. at 20 A
	1-phase AC (L-L)	1 x 870 VA typ. at 25 A 1 x 530 W guar. at 20 A
	DC (LL-LN)	1 x 700 W typ. at ±40 A
		1 x 500 W guar. at ±40 A
Accuracy <sup>4</sup>	Error < 0.05 % rd. <sup>5</sup> + 0.02 % rg. <sup>5</sup> typ. Error < 0.15 % rd. + 0.05 % rg. guar.	
Distortion (THD+N) <sup>6</sup>	< 0.05 % typ., < 0.15 % guar.	
Resolution	1 mA	
Max. compliance voltage (L-N)/(L-L)	35 Vpk / 70 Vpk	
Connection banana sockets	4 mm (0.16 in) banana sockets (32 A continuously)	
Connection combination socket	25 A continuously max.	

Voltage generators		
Setting range	4-phase AC (L-N)	4 x 0 ... 300 V (VL4(t) automatically calculated: VL4 = (VL1+VL2+VL3)*c or freely programmable)
	3-phase AC (L-N)	3 x 0 ... 300 V
	1-phase AC (L-L)	1 x 0 ... 600 V
	DC (L-N)	4 x 0 ... ±300 V
Power <sup>3</sup>	3-phase AC (L-N)	3 x 100 VA typ. at 100 ... 300 V 3 x 85 VA guar. at 85 ... 300 V
	4-phase AC (L-N)	4 x 75 VA typ. at 100 ... 300 V 4 x 50 VA guar. at 85 ... 300 V
	1-phase AC (L-N)	1 x 200 VA typ. at 100 ... 300 V 1 x 150 VA guar. at 75 ... 300 V
	1-phase AC (L-L)	1 x 275 VA typ. at 200 ... 600 V 1 x 250 VA guar. at 200 ... 600 V
	DC (L-N)	1 x 420 W typ. at ±300 V
		1 x 360 W guar. at ±300 V
Accuracy	Error < 0.03 % rd. <sup>5</sup> + 0.01 % rg. <sup>5</sup> typ. at 0 ... 300 V Error < 0.08 % rd. + 0.02 % rg. guar. at 0 ... 300 V	
Distortion (THD+N) <sup>6</sup>	0.015 % typ., < 0.05 % guar.	
Ranges	150 V / 300 V	
Resolution	5 mV / 10 mV in range 150 V / 300 V	
Connection	4 mm (0.16 in) banana sockets / combination socket (1,2,3,N)	
Generators, general		
Frequency	Range sine signals <sup>7</sup>	10 ... 1000 Hz
	Range harmonics / Interharmonics	Voltage: 10 ... 3000 Hz <sup>8</sup> Current: 10 ... 1000 Hz
	Range transient signals	DC ... 3.1 kHz <sup>8</sup>
	Accuracy / drift	±0.5 ppm / ±1 ppm
	Resolution	< 5 µHz
Phase	Angle range	-360° ... +360°
	Resolution	0.001°
	Error at 50 / 60 Hz	Voltage: 0.02° typ., < 0.1° guar. Current: 0.05° typ., < 0.2° guar. <sup>4</sup>
Bandwidth (-3 dB)	3.1 kHz	

<sup>1</sup> All data specified are guaranteed, except where indicated otherwise. OMICRON guarantees the specified data for one year after factory calibration, within 23 °C ±5 °C (73 °F ±10 °F) in the frequency range from 10 to 100 Hz and after a warm-up phase > 25 minutes

<sup>2</sup> Typical AC values valid for inductive loads (e.g. e/m relays)

<sup>3</sup> Continuous operation with full output power possible for 15 minutes

<sup>4</sup> Rload: 0 ... 0.5 Ω

<sup>5</sup> rd. = reading, rg. = range

<sup>6</sup> THD+N: Values at 50/60 Hz, > 1 A / 20 V with 20 kHz bandwidth

<sup>7</sup> For current outputs amplitude derating at > 380 Hz

<sup>8</sup> Amplitude derating at > 1000 Hz

<b>Low level outputs<sup>1</sup></b>	
Number of outputs	6 (12 with Option LLO-2)
Setting range	0 ... ±10 Vpk
Max. output current	1 mA
Accuracy	Error < 0.025 % typ., < 0.07 % guar. at 1 ... 10 Vpk
Resolution	250 µV
Distortion (THD+N) <sup>2</sup>	< 0.015 % typ., < 0.05 % guar.
Unconventional CT/VT simulation	Linear, Rogowski (transient and sinewave)
Overload indication	Yes
Isolation	SELV
Usability	Completely independent from internal amplifier outputs
Connection	16 pin combination socket (rear side)
<b>Auxiliary DC supply</b>	
Voltage ranges	0 ... 264 VDC, 0.2 A / 0 ... 132 VDC, 0.4 A / 0 ... 66 VDC, 0.8 A
Power	Max. 50 W
Accuracy	Error < 2 % typ., < 5 % guar.
<b>Binary inputs</b>	
Number	10
Trigger criteria	Toggling of potential-free contacts or DC voltage compared to threshold voltage
Input characteristics	0 ... ±300 VDC threshold or potential-free
Ranges	20 V / 300 V
Resolution of threshold	50 mV (0 ... 20 V), 500 mV (20 V ... 300 V)
Sample rate	10 kHz (resolution 100 µs)
Time stamping accuracy	±0.00015 % of rd. <sup>3</sup> ±70 µs
Max. measuring time	Infinite
Debounce / Deglitch time	0 ... 25 ms / 0 ... 25 ms
Counting function	< 3 kHz at pulse width > 150 µs
Galvanic isolation	5 galvanically isolated groups (2+2+2+2)
Max. input voltage	CAT IV / 150 V, CAT III / 300 V, transient immunity 2 kV
<b>Counter inputs 100 kHz</b>	
Number	2
Max. counting frequency	100 kHz
Pulse width	> 3 µs
Threshold voltage	6 V
Voltage hysteresis	2 V
Max. input voltage	±30 V
Isolation	SELV
Connection	16 pin combination socket (rear side)
<b>Trigger on overload</b>	
Supported generators	Current generators
Timer accuracy	Error < 1 ms

<b>Binary outputs, relays</b>	
Type	Potential-free relay contacts, software controlled
Number	4
Break capacity AC	Vmax: 300 VAC / I <sub>max</sub> : 8 A / P <sub>max</sub> : 2000 VA
Break capacity DC	Vmax: 300 VDC / I <sub>max</sub> : 8 A / P <sub>max</sub> : 50 W
<b>Binary outputs, transistor</b>	
Type	Open collector transistor outputs
Number	4
Update rate	10 kHz
I <sub>max</sub>	5 mA
Connection	16 pin combination socket (rear side)
<b>IEC 61850 GOOSE<sup>4</sup></b>	
Simulation	Mapping of binary outputs to data attributes in published GOOSE messages. Number of virtual binary outputs: 360 Number of GOOSEs to be published: 128
Subscription	Mapping of data attributes from subscribed GOOSE messages to binary inputs. Number of virtual binary inputs: 360 Number of GOOSEs to be subscribed: 128
Performance	Type 1A; Class P2/3 (IEC 61850-5). Processing time (application to network or vice versa): < 1 ms
VLAN support	Selectable priority and VLAN-ID
<b>IEC 61850 Sampled Values (Publishing)<sup>4</sup></b>	
Specification	According to the "Implementation Guideline for Digital Interface to Instrument Transformers Using IEC 61850-9-2" of the ICA International Users Group
Sampling Rate	80 samples per cycle for nominal frequencies of 50 Hz and 60 Hz.
Synchronization	Synchronization attribute (smpSynch) is set when the CMC is in synchronized operation mode. Sample count (smpCnt) zero is aligned with top of the second. Accuracy data see below
VLAN support	Selectable priority and VLAN-ID
Max. number of SV streams	2
<b>Time synchronization</b>	
Timing accuracy (voltage/current)	IRIG-B synchronization with CMIRIG-B GPS synchronization with CMGPS 588
To external voltage	Error < 1/5 µs typ., < 5/20 µs guar. Error < 1/5 µs typ., < 5/20 µs guar. Reference signal on binary input 10: 15 ... 70 Hz
Precision Time Protocol (PTP)	IEEE 1588-2008 IEEE C37.238-2011 (Power Profile)
<p>With the unique PermaSync functionality, analog and Sampled Values outputs stay permanently in sync with the internal CMC time reference.</p> <p>When a CMC is time-synchronized (IRIG-B, GPS, or PTP), the output quantities are continuously synchronized to the external time source.</p> <p>With CMIRIG-B it is also possible to transmit the internal PPS signal of the CMC to the device under test (e.g. PMUs or IEDs stimulated with a synchronized Sampled Values data stream).</p>	

<sup>1</sup> For directly testing relays with low level inputs by simulating signals from non conventional CTs and VTs with low level interfaces and for controlling external amplifier units

<sup>2</sup> THD+N: Values at 50/60 Hz, 20 kHz measurement bandwidth, nominal value, and nominal load

<sup>3</sup> rd. = reading

<sup>4</sup> The GOOSE and Sampled Values functionality require software licences for the respective configuration modules

## Technical Data CMC 353 (continued)

Power supply	
Nominal input voltage <sup>1</sup>	100 – 240 VAC, 1-phase
Permissible input voltage	85 ... 264 VAC
Nominal frequency	50/60 Hz
Permissible frequency range	45 ... 65 Hz
Rated current	12 A at 115 V / 10 A at 230 V
Connection	Standard AC socket (IEC 60320)
Environmental conditions	
Operation temperature <sup>2</sup>	0 ... +50 °C (+32 ... +122 °F)
Storage temperature	-25 ... +70 °C (-13 ... +158 °F)
Humidity range	Relative humidity 5 ... 95 %, non-condensing
Vibration	IEC 60068-2-6 (20 m/s <sup>2</sup> at 10 ... 150 Hz)
Shock	IEC 60068-2-27 (15 g/11 ms half-sine)
Safety standards, electromagnetic compatibility	
EMC	The product adheres to the electromagnetic compatibility (EMC) Directive 2004/108/EC (CE conform).
International	IEC 61326-1; IEC 61000-6-4; IEC 61000-3-2/3
USA	FCC Subpart B of Part 15 Class A
Safety	The product adheres to the low voltage Directive 2006/95/EC (CE conform).
International / USA	IEC 61010-1 / UL 61010-1
Canada	CAN/CSA-C22.2 No 61010-1-04
Miscellaneous	
Weight	13.3 kg (29.3 lbs)
Dimensions (W x H x D, without handle)	343 x 145 x 390 mm (13.5 x 5.7 x 15.4 in)
PC connection	Two PoE <sup>3</sup> Ethernet ports: <ul style="list-style-type: none"> <li>• 10/100 Mbit/s (10/100 Base-TX, auto-crossover)</li> <li>• IEEE 802.3af compliant</li> <li>• Port capability limited to one Class 1 (3.84 W) and one Class 2 (6.49 W) powered device</li> </ul> USB 2.0 port: <ul style="list-style-type: none"> <li>• Full speed (Type B connector)</li> </ul>
Signal indication (LED)	> 42 V for voltage and current outputs and AUX DC
Connection to ground (earth)	4 mm (0.16 in) banana socket (rear side)
Hardware diagnostics	Self diagnostics upon each start-up
Galvanically separated groups	The following groups are galvanically separated from each other: mains, voltage amplifier output, current amplifier output, auxiliary DC supply, binary/analog input
Protection	All current and voltage outputs are fully overload and short circuit proof and protected against external high-voltage transient signals and over temperature
Certifications	
 	
Developed and manufactured under an ISO 9001 registered system	

## Ordering Information

CMC 353 with Test Universe software	
VE002902	CMC 353 Basic
VE002903	CMC 353 Protection
VE002904	CMC 353 Advanced Protection
VE002911	CMC 353 Recloser

CMC 353 with CMControl (without Test Universe software)	
VE002908	CMC 353 with CMControl P
VE002910	CMC 353 with CMControl R
VE002912	CMC 353 with CMControl P App activation key

The CMControl can also be ordered as add-on together with a CMC 353 with Test Universe software or as a later upgrade.

CMC 353 hardware options	
VEHO2905	Option LLO-2 if ordered with a new unit
VEHO2906	Option LLO-2 if ordered as an upgrade

<sup>1</sup> For line input voltages below 230 V, a derating of the simultaneously available sum output power of the voltage/current amplifiers and the AuxDC will occur. All other technical specifications (e.g. the maximum output power of a single amplifier) are not affected.

<sup>2</sup> For an operational temperature above +30 °C (+86 °F) a duty cycle of down to 50 % may apply.

<sup>3</sup> PoE = Power over Ethernet

## CMC 310: 3 Phase Current + 3 Phase Voltage Test Set

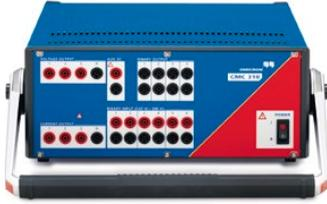

The CMC 310 is specifically designed for manual three-phase testing of protection and measurement devices. The lightweight and compact design makes the CMC 310 particularly suitable for testing distribution and industrial systems. If automated testing is requested, a CMC 310 can be upgraded to a CMC 353 at any time which then can be operated by the PC based Test Universe software.

Operation: CMControl

### Technical Data<sup>1</sup>

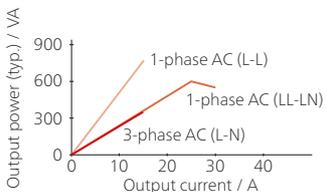
Current generators		
Setting range	3-phase AC (L-N)	3 x 0 ... 15 A
	1-phase AC (L-L)	1 x 0 ... 15 A
	1-phase AC (LL-LN)	1 x 0 ... 30 A
	DC (LL-LN)	1 x 0 ... ±30 A
Power <sup>2,3</sup>	3-phase AC (L-N)	3 x 350 VA typ. at 15 A 3 x 200 W guar. at 15 A
	1-phase AC (L-L)	1 x 780 VA typ. at 15 A 1 x 440 W guar. at 15 A
	1-phase AC (LL-LN)	1 x 500 VA typ. at 30 A 1 x 350 W guar. at 30 A
		
Accuracy <sup>4</sup>	error < 0.05 % rd. <sup>5</sup> + 0.05 % rg. <sup>5</sup> typ. error < 0.15 % rd. + 0.15 % rg. guar.	
Distortion (THD+N) <sup>6</sup>	< 0.15 % typ., < 0.35 % guar.	
Resolution	1 mA	
Max. compliance voltage (L-N)/(L-L)	35 Vpk / 70 Vpk	
Connection banana sockets	4 mm (0.16 in) banana sockets	

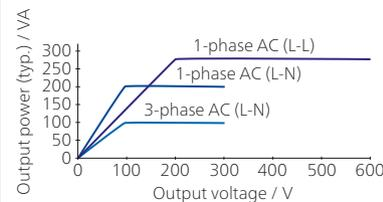
Voltage generators		
Setting Range	3-phase AC (L-N)	3 x 0 ... 300 V
	1-phase AC (L-N)	1 x 0 ... 300 V
	1-phase AC (L-L)	1 x 0 ... 600 V
	DC (L-N)	3 x 0 ... ±300 V
Power <sup>3</sup>	3-phase AC (L-N)	3 x 100 VA typ. at 100 ... 300 V 3 x 85 VA guar. at 85 ... 300 V
	1-phase AC (L-N)	1 x 200 VA typ. at 100 ... 300 V 1 x 150 VA guar. at 75 ... 300 V
		1 x 275 VA typ. at 200 ... 600 V 1 x 250 VA guar. at 200 ... 600 V
	DC (L-N)	1 x 420 W typ. at ±300 V 1 x 360 W guar. at ±300 V
		
Accuracy	Error < 0.03 % rd. <sup>5</sup> + 0.01 % rg. <sup>5</sup> typ. at 0 ... 300 V Error < 0.08 % rd. + 0.02 % rg. guar. at 0 ... 300 V	
Distortion (THD+N) <sup>6</sup>	0.015 % typ., < 0.05 % guar.	
Ranges	150 V / 300 V	
Resolution	5 mV / 10 mV in range 150 V / 300 V	
Connection	4 mm (0.16 in) banana sockets	
Generators, general		
Frequency	Range sine signals	10 ... 599 Hz
	Accuracy / drift	±0.5 ppm / ±1 ppm
	Resolution	< 5 µHz
Phase	Angle range	-360° ... +360°
	Resolution	0.001°
	Error at 50 / 60 Hz	Voltage: 0.02° typ., < 0.1° guar. Current: 0.05° typ., < 0.2° guar. <sup>4</sup>

<sup>1</sup> All data specified are guaranteed, except where indicated otherwise.  
OMICRON guarantees the specified data for one year after factory calibration, within 23 °C ± 5 °C (73 °F ± 10 °F) in the frequency range from 10 to 100 Hz and after a warm-up phase > 25 minutes

<sup>2</sup> Typical AC values valid for inductive loads (e.g. e/m relays)

<sup>3</sup> Continuous operation with full output power possible for 15 minutes

<sup>4</sup> Rload: 0 ... 0.5 Ω

<sup>5</sup> rd. = reading, rg. = range

<sup>6</sup> THD+N: Values at 50/60 Hz, > 1 A / 20 V with 20 kHz bandwidth

## Technical Data CMC 310 (continued)

Auxiliary DC supply	
Voltage ranges	0 ... 264 VDC, 0.2 A / 0 ... 132 VDC, 0.4 A / 0 ... 66 VDC, 0.8 A
Power	Max. 50 W
Accuracy	Error < 2 % typ., < 5 % guar.
Binary inputs	
Number	6
Trigger criteria	Toggling of potential-free contacts or DC voltage compared to threshold voltage
Input characteristics	0 ... ±300 VDC threshold or potential-free
Ranges	20 V / 300 V
Resolution of threshold	50 mV (0 ... 20 V), 500 mV (20 V ... 300 V)
Sample rate	10 kHz (resolution 100 µs)
Time stamping accuracy	±0.00015 % of reading ±70 µs
Max. measuring time	Infinite
Debounce / Deglitch time	0 ... 25 ms / 0 ... 25 ms
Counting function	< 3 kHz at pulse width > 150 µs
Galvanic isolation	3 galvanically isolated groups (2+2+2)
Max. input voltage	CAT IV / 150 V, CAT III / 300 V
Trigger on overload	
Supported generators	Current generators
Timer accuracy	Error < 1 ms
Binary outputs, relays	
Type	Potential-free relay contacts, software controlled
Number	4
Break capacity AC	Vmax: 300 VAC / Imax: 8 A / Pmax: 2000 VA
Break capacity DC	Vmax: 300 VDC / Imax: 8 A / Pmax: 50 W
Power supply	
Nominal input voltage	100 – 240 VAC, 1-phase
Permissible input voltage	85 ... 264 VAC
Nominal frequency	50/60 Hz
Permissible frequency range	45 ... 65 Hz
Power consumption	1.7 kVA at 115 V / 2.3 kVA at 230 V
Rated current	12 A at 115 V / 10 A at 230 V
Connection	Standard AC socket (IEC 60320)
Environmental conditions	
Operation temperature <sup>1</sup>	0 ... +50 °C (+32 ... +122 °F)
Storage temperature	-25 ... +70 °C (-13 ... +158 °F)
Humidity range	Relative humidity 5 ... 95 %, non-condensing
Vibration	IEC 60068-2-6 (20 m/s <sup>2</sup> at 10 ... 150 Hz)
Shock	IEC 60068-2-27 (15 g/11 ms half-sine)
Safety standards, electromagnetic compatibility	
EMC	The product adheres to the electromagnetic compatibility (EMC) Directive 2004/108/EC (CE conform).
International	IEC 61326-1; IEC 61000-6-4; IEC 61000-3-2/3
USA	FCC Subpart B of Part 15 Class A
Safety	The product adheres to the low voltage Directive 2006/95/EC (CE conform).
International / USA	IEC 61010-1 / UL 61010-1
Canada	CAN/CSA-C22.2 No 61010-1-04

Miscellaneous	
Weight	13.1 kg (28.9 lbs)
Dimensions (W x H x D, without handle)	343 x 145 x 390 mm (13.6 x 5.7 x 15.4 in)
CMControl P connection	One PoE <sup>2</sup> Ethernet port: <ul style="list-style-type: none"> <li>• 10/100 Mbit/s (10/100 Base-TX, auto-crossover)</li> <li>• IEEE 802.3af compliant (Class 2, 6.49 W)</li> </ul>
Signal indication (LED)	> 42 V for voltage and current outputs and AUX DC
Connection to ground (earth)	4 mm (0.16 in) banana socket (rear side)
Hardware diagnostics	Self diagnostics upon each start-up
Galvanically separated groups	The following groups are galvanically separated from each other: mains, voltage amplifier output, current amplifier output, auxiliary DC supply, binary/analog input
Protection	All current and voltage outputs are fully overload and short circuit proof and protected against external high-voltage transient signals and over temperature
Certifications	
 	
Developed and manufactured under an ISO 9001 registered system	

## Ordering Information

CMC 310 with CMControl P	
VE003001	CMC 310 with CMControl P
CMC 310 for tablet control	
VE003002	CMC 310 with CMControl P App activation key (for tablet control)
Upgrade to CMC 353 with CMControl P	
VEHO3001	Upgrade from "CMC 310 with CMControl P" to "CMC 353 with CMControl P"
Upgrade to CMC 353 for tablet control	
VEHO3002	Upgrade from "CMC 310 with CMControl P App activation key" to "CMC 353 with CMControl P App activation key"
Upgrade to CMC 353 with Test Universe software	
VEHO3003	Upgrade from CMC 310 (with CMControl P or CMControl P App activation key) to CMC 353 + Test Universe software (Basic Package)

<sup>1</sup> For an operational temperature above +30 °C (+86 °F) a duty cycle of down to 50 % may apply.

<sup>2</sup> PoE = Power over Ethernet

## CMC 850: IEC 61850 Test Set



The CMC 850 is OMICRON's protection test set dedicated to IEC 61850. It focuses on the real-time communication methods of GOOSE and Sampled Values to interface with the devices under test. The test set works with the proven Test Universe software and offers even more useful functions embedded directly in the device.

Operation: PC

### Technical Data

IEC 61850 GOOSE	
Simulation	Mapping of binary outputs to data attributes in published GOOSE messages. Number of virtual binary outputs: 360 Number of GOOSEs to be published: 128
Subscription	Mapping of data attributes from subscribed GOOSE messages to binary inputs. Number of virtual binary inputs: 360 Number of GOOSEs to be subscribed: 128
Performance	Type 1A; Class P2/3 (IEC 61850-5). Processing time (application to network or vice versa): < 1 ms
VLAN support	Selectable priority and VLAN-ID
IEC 61850 Sampled Values (Publishing)	
Specification	According to the "Implementation Guideline for Digital Interface to Instrument Transformers Using IEC 61850-9-2" of the IEC International Users Group
Sampling rate	80 samples per cycle for nominal frequencies of 50 Hz and 60 Hz.
Synchronization	Synchronization attribute (smpSynch) is set when the CMC is in synchronized operation mode. Sample count (smpCnt) zero is aligned with top of the second Accuracy data see below
VLAN support	Selectable priority and VLAN-ID
Max. number of SV streams	3
Communications interfaces	
Ethernet	Two PoE <sup>1</sup> Ethernet ports: <ul style="list-style-type: none"> <li>10/100 Mbit/s (10/100 Base-TX, auto-crossover)</li> <li>IEEE 802.3af compliant</li> <li>Port capability limited to one Class 1 (3.84 W) and one Class 2 (6.49 W) powered device</li> </ul>
Time synchronization	
Timing accuracy	Error < 1 μs typ., < 5 μs guar.
IRIG-B synchronization with CMIRIG-B	Error < 1 μs typ., < 5 μs guar.
GPS synchronization with CMGPS 588	IEEE 1588-2008
Precision Time Protocol (PTP)	IEEE C37.238-2011 (Power Profile)
With the unique PermaSync functionality, analog and Sampled Values outputs stay permanently in sync with the internal CMC time reference. When a CMC is time-synchronized (IRIG-B, GPS, or PTP), the output quantities are continuously synchronized to the external time source. With CMIRIG-B it is also possible to transmit the internal PPS signal of the CMC to the device under test (e.g. PMUs or IEDs stimulated with a synchronized Sampled Values data stream).	

Low level outputs <sup>2</sup>	
Number of outputs	12
Setting range	0 ... ±10 Vpk
Max. output current	1 mA
Accuracy	Error < 0.025 % typ., < 0.07 % guar. at 1 ... 10 V
Resolution	250 μV
Distortion (THD+N) <sup>3</sup>	< 0.015 % typ., < 0.05 % guar.
Unconventional CT/VT simulation	Linear, Rogowski (transient and sine wave)
Overload indication	Yes
Isolation	SELV
Connection	2 x 16 pin combination socket
Binary outputs, transistor	
Type	Open collector transistor outputs
Number	4
Update rate	10 kHz
Imax	5 mA
Connection	16 pin combination socket
External power supply unit	
Nominal / permissible input voltage	100 – 240 VAC / 99 ... 264 VAC (50/60 Hz)
Output voltage	48 VDC (±6.25 %)
Rated current	1.66 A
Rated power	80 W
Environmental conditions	
Operation temperature	0 ... +50 °C (+32 ... +122 °F)
Storage temperature	-25 ... +70 °C (-13 ... +158 °F)
Humidity range	Relative humidity 5 ... 95 %, non-condensing
Vibration	IEC 60068-2-6 (20 m/s <sup>2</sup> at 10 ... 150 Hz)
Shock	IEC 60068-2-27 (15 g/11 ms half-sine)
Safety standards, electromagnetic compatibility	
EMC	The product adheres to the electromagnetic compatibility (EMC) Directive 2004/108/EC (CE conform).
International	IEC 61326-1; IEC 61000-6-4; IEC 61000-3-2/3
USA	FCC Subpart B of Part 15 Class A
Safety	The product adheres to the low voltage Directive 2006/95/EC (CE conform).
International / USA	IEC 61010-1 / UL 61010-1
Canada	CAN/CSA-C22.2 No 61010-1-04
Mechanical data	
Weight	1.7 kg (3.7 lbs)
Dimensions (W x H x D)	85 x 145 x 325 mm (3.3 x 5.7 x 12.8 in)
Certifications	
	
Developed and manufactured under an ISO 9001 registered system	

<sup>1</sup> PoE = Power over Ethernet

<sup>2</sup> For directly testing relays with low level inputs by simulating signals from non conventional CTs and VTs with low level interfaces and for controlling external voltage or current amplifiers

<sup>3</sup> THD+N: Values at 50/60 Hz, 20 kHz measurement bandwidth, nominal value, and nominal load

## CMControl: Front Panel Control for CMC Test Sets



The CMControl is a PC-independent control alternative for CMC test sets, specifically designed for quick manual testing in the field. The device can either be attached to the CMC test set or be detached and used as a flexible handheld control.

The CMControl supports the following applications:

- > Testing of protection and measurement devices (version P)
- > Testing of recloser and sectionalizer controls (version R)

The two versions differ in the software running on the CMControl. It is possible to cover both applications with the same device by ordering both versions in combination or by upgrading at a later stage. The CMControl is available in two variants: CMControl-6 for CMC 356, CMC 256plus, CMC 256-6 and CMControl-3 for CMC 353 and CMC 310 (version P).

### Technical Data

Display	
Size / Type	7" WVGA (800 x 480 px) / transfective (sunlight readable)
Brightness / Contrast	400 Cd/m <sup>2</sup> (max) / 900:1
Backlight	LED (adapts to ambient light)
Touchscreen	Capacitive with anti-glare glass
Communications interfaces	
Ethernet Connection	One rugged PoE <sup>1</sup> Ethernet port: <ul style="list-style-type: none"> <li>• 10/100 Mbit/s (10/100 Base-TX, auto-crossover)</li> <li>• IEEE 802.3af, Class 2 (6.49 W) powered device</li> </ul>
USB Connection	One USB 2.0 port: <ul style="list-style-type: none"> <li>• up to 480 Mbit/s</li> <li>• mass storage compliant</li> </ul>
External power supply unit <sup>2</sup>	
Device type	IEEE 802.3at, Power over Ethernet port injector
Nominal / permissible input voltage	100 – 240 VAC / 90 ... 264 VAC (50/60 Hz)
Max. output power	33.6 W
Environmental conditions	
Operation temperature	0 ... +50 °C (+32 ... +122 °F)
Storage temperature	-25 ... +70 °C (-13 ... +158 °F)
Humidity range	Relative humidity 5 ... 95 %, non-condensing
Vibration	IEC 60068-2-6 (20 m/s <sup>2</sup> at 10 ... 150 Hz)
Shock	IEC 60068-2-27 (15 g/11 ms half-sine)
Safety standards, electromagnetic compatibility	
EMC	The product adheres to the electromagnetic compatibility (EMC) Directive 2004/108/EC (CE conform).
International	IEC 61326-1; IEC 61000-6-4; IEC 61000-3-2/3
USA	FCC Subpart B of Part 15 Class A
Safety	The product adheres to the low voltage Directive 2006/95/EC (CE conform).
International / USA	IEC 61010-1 / UL 61010-1
Canada	CAN/CSA-C22.2 No 61010-1-04
Mechanical data	
Weight	CMControl-3: 1.8 kg (4.0 lbs) CMControl-6: 2.1 kg (4.6 lbs)
Dimensions (W x H x D)	CMControl-3: 345 x 140 x 43 mm (13.6 x 5.5 x 1.7 in) CMControl-6: 450 x 140 x 43 mm (17.7 x 5.5 x 1.7 in)
Certifications	
	TÜV-GS, TÜV-NRTL
	Developed and manufactured under an ISO 9001 registered system
Delivery contents	
	CMControl-3 or -6, USB flash drive 1 GB, Ethernet patch cable with rugged RJ45 connector 5 m (16.4 ft), Ethernet patch cable 0.75 m (2.5 ft), mounting material, soft bag

<sup>1</sup> PoE = Power over Ethernet

<sup>2</sup> For the operation with CMC 356, CMC 256plus, and CMC 256-6 test sets with NET-1 an external power supply unit is included in delivery. If Power over Ethernet is desired, a PoE-Upgrade for these test sets is available (VEHO1017)

<sup>3</sup> For test sets with parallel port a PoE-Upgrade is required

<sup>4</sup> With Test Universe Software

<sup>5</sup> Without Test Universe Software

### Ordering Information

#### Version P

CMControl P as add-on for new CMC <sup>4</sup>	CMControl P as add-on for existing CMC	CMC + CMControl P Package <sup>5</sup>	
VEHO2805	VEHO2806 <sup>2,3</sup>	VE002820	CMC 356
		VE002715	CMC 256plus
VEHO2901	VEHO2902	VE002908	CMC 353
-	-	VE003001	CMC 310

#### Version R

CMControl R as add-on for new CMC <sup>4</sup>	CMControl R as add-on for existing CMC	CMC + CMControl R Package <sup>5</sup>	
VEHO2807	VEHO2808 <sup>2,3</sup>	VE002824	CMC 356
		VE002719	CMC 256plus
VEHO2903	VEHO2904	VE002910	CMC 353

### Software-Upgrade

For using both versions (P + R) with a new or existing CMControl device, the following options are offered:

Upgrade from version P to the combination P + R	VESM2728
Upgrade from version R to the combination P + R	VESM2729

### CMControl P App



For testing of protection and measurement devices it is also possible to control a CMC with an Android tablet and the CMControl P App.

You can download the CMControl P App from the Google Play Store™ and familiarize yourself with all its features.

Learn more at [www.omicron.at/cmcontrol-p](http://www.omicron.at/cmcontrol-p)



Scan the QR code to get the App directly from the GOOGLE Play Store™.

## CMGPS 588 Synchronization Unit



The CMGPS 588 synchronization unit is an antenna-integrated GPS controlled time reference optimized for outdoor usage. It works as a Precision Time Protocol (PTP) Grandmaster Clock and does not require any configuration work. It is automatically ready for operation within a very short time after providing power supply via Power over Ethernet (PoE). The distance between the CMGPS 588 and the CMC can be extended up to 95 m (312 ft) by using extension cables.

### Compatible test sets

- > CMC 356, CMC 353, CMC 850, CMC 256plus and CMC 256-6 with NET-1B or NET-1C and Test Universe 3.0 or later
- > DANEO 400

### Applications

- > Synchronizing output signals to the atomic clocks of the GPS system for distributed synchronized tests
- > Starting distributed tests synchronously at a configurable time (for example, for performing end-to-end tests of line protection schemes)
- > UTC or TAI synchronized recordings

### Specifications

GPS data	
Timing accuracy	±100 ns to reference time (TAI/UTC)
Supported timing protocols	PTP Power Profile according to IEEE 1588-2008 and IEEE C37.238-2011
GPS performance	12 channel GPS receiver, Frequency: 1575.42 MHz, L1 band
Power supply	
Power supply	Power over Ethernet (PoE), class 1 powered device according to IEEE 802.3af
Power consumption	< 2 W
Environmental conditions	
Operating temperature	-40 °C ... +70 °C (-40 °F ... +158 °F)
Storage temperature	-40 °C ... +85 °C (-40 °F ... +185 °F)
Degree of protection	Robust and waterproof, IP67 according to IEC 60529
Vibration	IEC 60068-2-6, Test Fc, sinusoidal vibration, 6 mm at 5 – 9 Hz, 2 g at 9 – 200 Hz
Shock	IEC 60068-2-27, Test Ea, 15 g/11 ms half sine
Safety standards, electromagnetic compatibility	
EMC	The product adheres to the electromagnetic compatibility (EMC) Directive 2004/108/EC (CE conform).
Emission	EN 55022:2010 class B, EN 61326-1:2006
Immunity	EN 55024:2010, EN 61326-1:2006, EN 62305-4:2010
Safety	IEC 60950-1:2005 2 Ed. +A1:2009, IEC 60950-22:2005
General	
Weight	500 g (1.1 lbs)
Dimensions	Height (without connector and tripod): 106 mm (4.2 in) Diameter: 116 mm (4.6 in)
Ethernet port	Waterproof Ethernet connector according to IEC 61076-3-106 (variant 4), 10Base-T/100 Base-TX
Certifications	TÜV
Delivery contents	
CMGPS 588 synchronization unit with integrated antenna and timing receiver, hardtop case, 15 m (49 ft) rugged ethernet cable with waterproof connector, tripod	

### Ordering Information

Order number	Delivery contents
VEHZ3004	CMGPS 588 Synchronization Unit
VEHK0303	40 m (131 ft) rugged ethernet cable reel as extension (2 extensions possible)



CMIRIG-B is an interface box enabling the connection of devices sending or receiving the IRIG-B protocol or PPS signals with CMC test sets<sup>1</sup>. CMIRIG-B performs the level conversion between the CMC and the sources or receivers. The actual IRIG-B decoding and coding functionality is implemented in the CMC test set. CMGPS 588 can optionally be used as PTP Grandmaster Clock in order to establish a link to absolute UTC time.

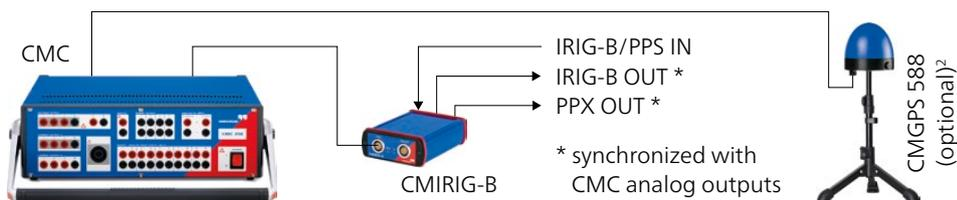

Typical applications for CMIRIG-B are:

- > Synchronization of the analog outputs of two or more CMC test sets with an external IRIG-B protocol or 1PPS signal. Example: End-to-end testing
- > Testing of wide area protection with IRIG-B functionality using the IRIG-B time protocol generated by the CMC test set. Example: Testing of phasor measurement units (PMU). Supported standard (IRIG-B extension): IEEE C37.118 (Synchrophasor standard)
- > Master/Slave Operation: A CMC test set (master) generates an IRIG-B protocol and synchronizes other CMC test sets (slaves) at the same location

Software modules supporting CMIRIG-B:

State Sequencer, Pulse Ramping, Advanced TransPlay, Advanced Differential, NetSim, PQ Signal Generator and EnerLyzer.

### Specifications

<b>IRIG-B output</b>	
IRIG-Standard	200-04
Data formats	B00x (demodulated, DC level-shift), B20x (Manchester modulated, DC level-shift)
Characteristic	5 V (TTL), 150 mA, for 50 Ω coaxial signal distribution
Synchrophasor (PMU) testing	Configurable with or without IEEE C37.118 extensions
<b>PPX output</b>	
Configurable pulse output, rising edge is in coincidence with the change of an UTC second. e.g. 1PPS (1 pulse per second: pulse rate = 1 s)	
Output characteristic	5 V (TTL), 150 mA, for 50 Ω coaxial signal distribution
Minimum pulse length	1 ms
Pulse rate	IRIG-B encoder: 1 s IRIG-B decoder: 0=single, 1 ... 65535 seconds
<b>IRIG-B input</b>	
IRIG-B input is used, if IRIG-B decoder is configured	
IRIG-Standard	200-04
Data formats	B00x (demodulated, DC level-shift)
Characteristic	5 V (TTL)
Synchrophasor (PMU) testing	Configurable with or without IEEE C37.118 extensions
<b>PPS input</b>	
PPS input is used if external PPS source is connected and IRIG-B encoder is configured	
<b>Timing</b>	
Delay time PPS source to PPX output	Typ. < 1 μs, max. 1.5 μs
Time skew PPX output to IRIG-B output	Typ. < 0.1 μs, max. 0.5 μs
Time error of time reference source to analog outputs <sup>3</sup>	Typ. < ±1 μs, max. ±5 μs <sup>4</sup>
<b>Mechanical data</b>	
Weight	260 g (0.57 lb)
Dimensions (W x H x D)	83 x 35 x 130 mm (3.3 x 1.4 x 5.1 in)
<b>Delivery contents</b>	
CMIRIG-B interface box, 16-pole LEMO cable [VEHK0003]	

<sup>1</sup> CMC 356, CMC 353, CMC 256plus, CMC 256-6 with any NET-1 hardware option, CMC 850

<sup>2</sup> CMC 356, CMC 353, CMC 256plus, CMC 850

<sup>3</sup> Valid for CMC output frequencies < 100 Hz and re-synchronized analog output signals

<sup>4</sup> CMC 356 and CMC 353: typ. < ±5 μs, max. ±20 μs

## SEM Scanning Equipment for Meters



### SEM 1 Scanning Equipment for Meters

SEM 1 [VEHZ1158] contains the OSH 256 passive optical scanning head to detect the status of optical pulse LEDs of electronic energy meters.

This lightweight scanning head can be attached to smooth surfaces by means of its suction cup or by a re-usable adhesive rubber compound in case of a non-planar surface. The adhesive rubber compound additionally screens the sensor from ambient light.

An adapter cable for direct connection to the external interface (EXIF) connector on the rear of a CMC 256, CMC 356 or CMC 353 is included in delivery.



### SEM 2 Scanning Equipment for Meters

SEM 2 [VEHZ1157] contains the photoelectric scanning head TK 326 which is suitable for scanning of all known rotor marks of Ferraris meters and for scanning of optical pulse outputs of electronic meters up to the infrared wavelength range.

An adapter cable for direct connection to the external interface (EXIF) connector on the rear of a CMC 256, CMC 356, or CMC 353 is included in delivery.



### SEM 3 Scanning Equipment for Meters

SEM 3 [VEHZ1156] contains the photoelectric scanning head SH 2015 to detect pulses from electronic meters. This scanning head provides a ring magnet to attach the unit to solid-state meters.

An adapter cable for direct connection to the external interface (EXIF) connector on the rear of a CMC 256, CMC 356, or CMC 353 is included in delivery.



### CMLIB B Set

A CMLIB B set [VEHZ1102] supports specific tests beyond the simple set-up with the adapter cable. The CMLIB B comprises the CMLIB B Box, the 16-pole connection cable to CMCs and a power supply.

Cases where the adapter cable cannot replace a CMLIB B:

- > if the scanning head is used in conjunction with a CMC 156 (EP) test set
- > in cases where reference meters are used where two pulse inputs are needed
- > for accessing the binary transistor outputs of a CMC

## SER Scanning Equipment for Relays

VEHZ1155



### SER 1 Scanning Equipment for Relays

SER 1 contains the OSH 256R passive optical scanning head which is specially designed for reading the status indication LEDs of protection relays. Any timing tests including pick-up / drop-out can be carried out. For connecting its binary output signal to one of the binary inputs of a CMC 356, or CMC 353, or CMC 256plus test set, the interface box IFB 256 is included in delivery.

The lightweight scanning head can be attached to smooth surfaces by means of its suction cup or by a re-usable adhesive rubber compound in case of a non-planar surface. The adhesive rubber compound additionally screens the sensor from ambient light.

Power supply to the scanning head is provided by direct connection to the external interface (EXIF) socket of the CMC test set by means of its 16-pole LEMO connector.

## CMLIB A Low Level Signal Connector

VEHZ1105



CMLIB A is used for connecting the low level signal outputs of a CMC for measurement or controlling purposes. It can also be used to connect the inputs of a CMA 156 or CMS 156 with third party signal sources.

The CMLIB A Set [VEHZ1105] includes the CMLIB A Box [VEHZ1101] and the 16-pole-LEMO cable [VEHK0003].

Connection cables can be ordered separately

- > BNC to BNC cable [VEHK0008]
- > BNC to 4 mm (0.16 in) banana cable [VEHK0005]

## Cable Connector for REF 54x

VEHK0120



This connection cable with Twin-BNC clamp plugs type AMPHENOL 31-224 is tailored to connect ABB relays of the REF 54x series (with AMPHENOL Twin-BNC bulkhead receptacles type 31-223) to the low level outputs of a CMC test set (16-pole LEMO connector). Cable length: approx. 2.5 m (8.2 ft). The six cable tails with the AMP connectors are labeled.

The CMC test set in such applications simulates unconventional transformers and/or Rogowski coils (supported by CMC 356, CMC 353, CMC 256plus, and CMC 850).

## CMLIB REF6xx Interface Adapter

VEHZ1113



The CMLIB REF6xx is an interface adapter for connecting ABB feeder protection relays fitted with sensor inputs (e.g. REF615 or REF601) to the low level outputs of CMC test sets. For Rogowski sensor simulation, CMLIB REF6xx converts the low-level output signals of the CMC into differential (balanced) signals. In addition, the adapter also provides the simulated voltage system. CMLIB REF6xx can be used in combination with CMC 356, CMC 353, CMC 256plus, CMC 256-6, and CMC 850 test sets.

## CMLIB 7Sx8 Interface Adapter

VEHZ1115



The CMLIB 7Sx8 is an interface adapter for connecting SIEMENS protection relays fitted with sensor inputs (e.g. SIPROTEC 7SJ81) to the low level outputs of CMC test sets. CMLIB 7Sx8 converts the low-level output signals of the CMC into differential (balanced) signals. In addition, the adapter also provides the simulated voltage system. CMLIB 7Sx8 can be used in combination with CMC 356, CMC 353, CMC 256plus, CMC 256-6, and CMC 850 test sets.

## RIB1 Low Level Isolation Box

VEHZ1160



RIB1 is used to isolate the SELV low voltage signals from CMC test sets. It is connected between the low level outputs of the test set and the device under test and provides a reinforced insulation to the low level outputs of a CMC test set.

## RXB1 Binary Output Extension

VEHZ1159



RXB1 is used to extend OMICRON test sets with binary relay outputs 5 to 8. Each extended binary output channel consists of a normally open (N.O.) and a normally closed (N.C.) contact.

## CPOL Polarity Checker

VEHZ0650



Polarity Checker checks a series of terminals for correct wiring (replacement for battery checking method). In conjunction with a CMC test set the signal can be injected into the primary side of a CT. Thus, the correct polarity of CT wiring can be included in the test.

A special continuous test signal is injected at one point with the CMC. Then the polarity at all terminals can be checked with CPOL. This procedure is much faster than the conventional method and can easily be performed by a single person.

CPOL can be used with the polarity checker software of Test Universe and the Wiring Check tool of CMControl P.

## C-Probe 1 Current Clamp

VEHZ4000



C-Probe 1 is an active AC and DC current probe with voltage output. It is the recommended accessory for measuring currents with the CMC 356 with ELT-1 hardware option or CMC 256-6, CMC 256plus and EnerLyzer software license. C-Probe 1 can also be used with the Multimeter tool of CMControl P.

Two measuring ranges	10 A and 80 A
Frequency range	DC to 10 kHz
Accuracy	Error < 2 % for currents up to 40 A and frequencies up to 1 kHz
Phase error	< 0.5° at 50/60 Hz
Length	230 mm (9.1 in)

## C-Shunt



C-Shunt is a precision shunt for current measurements. It can be directly inserted into the binary/analog inputs of a CMC 356 with ELT-1 hardware option, a CMC 256plus, or a CMC 256-6.

	<b>C-Shunt 1</b>	<b>C-Shunt 10</b>
Electrical resistance	0.001 $\Omega$	0.01 $\Omega$
Resistance tolerance	0.1 %	0.1 %
Temperature coefficient	$\leq 30$ ppm/K in the range 0 ... +70 °C (+32 ... +158 °F)	$\leq 15$ ppm/K in the range 0 ... +70 °C (+32 ... +158 °F)
Maximum current	32 A continuous	12.5 A continuous
Order number	VEHZ0080	VEHZ0081

## CMTAC 1 AC to DC Trigger Rectifier

VEHZ0091



Renewable energy systems such as wind energy plants often do not have battery arrangements for the provision of an auxiliary DC supply. In these installations the use of 230 V AC signals for the binary outputs has become an alternative.

By means of a CMTAC 1 the AC signal is converted to DC in order to connect such an output to a binary input of a CMC test set. Compared to the direct connection of the AC signal, this significantly reduces the maximum time error (maximum 3.5 ms).

A meaningful setting of the deglitch time for the binary inputs is essential for proper functioning. The maximum delay time is a function of the set deglitch time. The CMTAC 1 is delivered with a detailed instruction leaflet.

CMTAC 1 can be used with CMC 256-6, CMC 256 plus, CMC 356, CMC 353, and CMC 310 test sets.

## ARC 256x Arc Flash Initiator

VEHZ0092



For testing arc flash protection systems, the ARC 256x simulates an arc flash by means of a xenon flash tube. This CMC accessory is positioned close to the arc flash sensor during testing. It is connected to the external interface socket of the CMC test set, which provides both the supply voltage as well as the trigger signal. The protection system is then automatically tested using the State Sequencer module of the Test Universe software. This module controls the trigger signal of the flash tube and measures the time to operation.

The ARC 256x can be used in combination with CMC 356, CMC 353, CMC 256plus and CMC 256-6 test sets. It can be attached to a point or linear sensor by a re-usable adhesive rubber compound (1 pack rubber compound included).

## 100TX to 100FX-SC Converter

VEHZ0021



This converter connects a CMC or a DANEO 400 to a network via fiber optics. The 100TX to 100FX-SC Converter transfers data from a 10/100Base-TX copper to a fiber interface. It is designed to receive both data and power from PoE networks, and to pass on the data to a fiber optics connection.

Compliant to	IEEE 802.3/IEEE 802.3u, IEEE 802.3af Power over Ethernet
Connector	10/100 Base-TX: RJ45, 100 Base-FX: SC
LED indicators	Power, PoE, TP Link/Act, 100FX Link/Act, FDX/COL
Power supply	PoE Class 2 or power supply unit (not included)
Dimensions (W x H x D)	70 x 26 x 94 mm (2.8 x 1.0 x 3.7 in)

## PoE Injector

VEHZ0082



PoE Injector 33.6 W for electric energy supply to a CMControl attached to an older CMC (NET-1) or to the copper/fiber optic converter 100TX to 100FX-SC [VEHZ0021] or similar applications in networks without PoE.

Compliant to	IEEE802.3at
DC Output	56 V, 0.6 A
AC Input Range	90 ... 264 VAC / 47 ... 63 Hz
Dimensions (W x H x D)	65 x 36 x 140 mm (2.6 x 1.4 x 5.5 in)

## CMUSB-P USB to Parallel Converter

VEHZ2007



USB to Parallel Converter for controlling CMC test sets with a parallel port.

Compliant to	Connector type A, Full speed (12 MBit/s)
Power supply	Over USB (Power consumption: typ. < 100 mA)
Cable length	2.4 m (7.9 ft)
CMUSB-P firmware	Upgrades automatically done
Supported devices	CMC 156 (EP), CMC 256-6 <sup>1</sup> , CMC 256plus (PAR-1) <sup>1</sup> , CMB IO-7 <sup>1</sup>
Required software	Test Universe 2.30 or higher

## Generator Combination Cable

VEHK0103



Connection between the Generator-Combination-Plug of the CMC test set to the test object.

- CMC test set: Generator-Combination Plug 8-Pole
- Test object site: Safety Plug (4 mm/0.16 in) black
- 8 x 2.5 mm<sup>2</sup>, 3 m (9.8 ft)
- 3 x 25 A max continuously

## CMC Wiring Accessory Package

VEHZ0060

	Description	Specs.	Quantity
	Flexible test lead adapters with retractable sleeve (5 cm/2 in long) for connections to non-safety sockets in combination with the 2 m (6.6 ft) leads	600 V, 32 A	6 red, 6 black
	Flexible jumpers for paralleling current triples up to 32 A or shorting neutrals of binary inputs	1000 V, 32 A	4 black
	Crocodile clips for contacting pins or screw bolts	1000 V, 32 A	4 red, 4 black
	Flexible terminal adapters for screw-type terminals	1000 V, 32 A	12
	Cable lug adapters for M4 (0.15 in) screws	1000 V, 20 A	20
	Cable lug adapters for M5 (0.2 in) screws	1000 V, 20 A	10
	Cable ties (velcro fastener) black, 150 mm (5.9 in) long		10
	Accessory bag		1

<sup>1</sup> Existing connection cable VEHK0108 is still needed

## Standard Test Set Accessories

The following accessories are part of the CMx and DANEO 400 standard delivery but can also be ordered separately.

Description		CMC 356	CMC 256plus	CMC 353	CMC 310	CMC 850	DANEO 400
	Ethernet patch cable 1.5 m (4.9 ft), RJ45 To connect CMC test sets with Ethernet connection to PC or network [VEHK0022]	1	1	1	1	2	
	Ethernet patch cable 3 m (9.8 ft), RJ45 To connect CMC test sets with Ethernet connection to PC or network [VEHK0622]	1	1	1		2	1
	USB connection cable, 2 m (6.6 ft), A/B To connect CMC test sets with USB connection to a PC [VEHK0025]	1	1	1			1
	Leads with 4 mm (0.16 in) safety plugs 2 m (6.6 ft) long, 600 V (6 x red, 6 x black) [VEHK0112]	1	1	1	1		1
	Flexible terminal adapters (12 x black) [VEHS0009]	1	1	1	1		1
	Jumper, flexible, 6 cm (2.4 in) long (4 x black) for paralleling current triple A and B [VEHZ0009]	1	1				
	Flexible test lead adapters with retractable sleeve 5 cm (2.0 in) long, 600 V (6 x red, 6 x black) [VEHK0024]	1	1	1	1		
	C-Probe 1 Active AC and DC current probe with voltage output [VEHZ4000]						1
	Soft bag for CMC 356 / CMC 256plus size device without CMControl-6 [VEHP0012]	1	1				
	Soft bag for CMC 356 / CMC 256plus size device with CMControl-6 [VEHP0014]	or 1	or 1				
	Soft bag for CMC 353 / CMC 310 size device without CMControl-3 or DANEO 400 [VEHP0023]			1	1		1
	Soft bag for CMC 353 / CMC 310 size device with CMControl-3 [VEHP0013]			or 1	or 1		
	Bag for CMC 850 (black) [VEHP0017]					1	

# Accessories

## Transport Cases

	VEHP0021	VEHP0022
	Heavy-duty transport case with wheels and extendable handle for CMC 356, CMC 256plus with or without CMControl-6, CMA or CMS units	Heavy-duty transport case with wheels and extendable handle for CMC 353, CMC 310 with or without CMControl-3, DANEO 400
Dimension	660 x 570 x 415 mm (26 x 22.4 x 16.3 in)	570 x 490 x 415 mm (22.4 x 19.3 x 16.3 in)
Weight	10.8 kg (23.8 lbs)	8.9 kg (19.6 lbs)
Capacity	Test unit, CMControl, manual, test leads, current clamps, accessories	Test unit, CMControl, manual, test leads, accessories
Recommended use	The sturdy transport cases with hard-foam interior are designed for heavy transport stress and save shipping. The cases are watertight, airtight, dustproof, chemical resistant and corrosion proof.	

## Foldable Stand

	Description
	Foldable stand to place test sets in upright position [VEHZ0070]

## Recloser and Sectionalizer Control Test Cables



OMICRON offers a comprehensive range of cable packages for testing various recloser and sectionalizer controls as an accessory to CMC test sets.<sup>1</sup> After a simple change of the plug connected to the control to be tested, the CMC simulates the behavior of the recloser or sectionalizer in normal operation and provides all voltages, currents and status signals required for testing.

CMC recloser and sectionalizer control cable packages are offered for testing of:<sup>2</sup>

	Cable	RVP1	RST1	RCP1	ROV1	RGS1	RCS1	RVT1	RTO1	RSI1	H1	RSM1
	<b>Cable Pin Counts</b>	10	14	19	24	24	26	32	32	40	-	24
	<b>Article Number</b>	VEHK0218	VEHK0194	VEHK0193	VEHK0197	VEHZ1164	VEHZ1163	VEHZ1162	VEHZ1161	VEHZ0219	VEHZ1153	VEHK0222
	<b>Switch Type<sup>3</sup></b>	T&B Elastimold MVR G&W Viper SP	Cooper NOVA G&W Viper S	T&B Elastimold MVR Cooper NOVA G&W Viper S	ABB OVR/VR3S	ABB GridShield	Cooper NOVA-TS/STS	G&W Viper ST/LT T&B Elastimold MVR	Tavrda OSM_AI_2	Siemens SDR T/S	S&C IntelliRupter	S&C ScadaMate
<b>Controller</b>	ABB PCD				•							
	ABB RER620					•						
	Cooper Form 4C		•	•								
	Cooper Form 4D		•	•								
	Cooper Form 5		•	•			•					
	Cooper Form 6		•	•			•					
	Cooper FXB		•									
	GE URC		•									
	ICMI URC II		•	•	•				•			
	S&C 5800 Series											•
	S&C 6800 Series											•
	S&C IntelliRupter Controller										•	
	Schweitzer – SEL351R			•								
	Schweitzer – SEL351R Falcon			•								
	Schweitzer – SEL351RS Kestrel	•										
	Schweitzer – SEL651R		•	•	•	•	•	•	•	•	•	
	Siemens 7SR224										•	

For quick manual testing in the field, CMControl is the ideal choice for operating the CMC test sets. Its new touch screen applications and specific tools for testing recloser and sectionalizer controls are particularly easy to work with.

For highly automated testing a CMC test set can also be controlled via the Test Universe software running on a Windows PC. For this kind of application OMICRON offers free sample test plans<sup>4</sup> which can be downloaded from the OMICRON website.

<sup>1</sup> CMC 356, CMC 256plus, CMC 353

<sup>2</sup> Non-exhaustive list of supported controllers. For the complete list please visit our website

<sup>3</sup> Non-exhaustive list of switches using the respective interface

<sup>4</sup> OMICRON Control Center (OCC) required



ISIO 200 is a simple and versatile binary I/O terminal for Substation Automation Systems (SAS). It communicates via IEC 61850 GOOSE messages and, therefore, interoperates with CMC test sets supporting GOOSE and a wide range of intelligent electronic devices (IED). ISIO 200 is configured via a built-in web interface and no special configuration software needs to be installed.

Use ISIO 200 in combination with a CMC test set to extend its binary I/O capability or integrate it as a component in a SAS to handle additional binary signals. Due to its compact design, additional binary I/O terminals can be placed wherever necessary.

### Testing in Substation Automation Systems with CMC Test Sets<sup>1</sup>

#### Access to remote binary I/O terminals

Connecting to binary I/Os that are more than just a few meters away from the test set is often cumbersome. The ISIO 200 can be conveniently placed close to remote access points to keep the conventional wiring as short as possible. The longer distance to the test set is simply bridged with an Ethernet cable.

#### Permanently installed terminal for testing

The binary I/Os of a protection relay are permanently wired to an ISIO 200. For testing, the binary wiring of the test set is reduced to connecting the Ethernet cable.

#### Testing sophisticated protection schemes with CMC test sets and ISIO 200

When testing protection schemes with main and backup protection and telecommunication, the setup can easily get so complex that more than 10 binary inputs and 4 binary outputs are required. In such cases, the ISIO 200 is the ideal extension of the CMC's binary I/O capabilities.

### Operating ISIO 200 in Substation Automation Systems

#### I/O terminal for SAS utilizing GOOSE

The frequent need for a few additional binary I/Os in a substation automation system is easily and efficiently facilitated with the ISIO 200. If the I/O capabilities of an IED are exhausted but more binary I/Os are still needed, an ISIO 200 "connected" via GOOSE delivers this.

#### Back-to-back binary I/O forwarding via Ethernet

By using two ISIO 200 "back-to-back", binary status information is tunneled over the substation network. If ordered in matched pairs, the two ISIO 200s are preconfigured to subscribe to each other.

### Ordering Information

Order number	Delivery contents
VESC1600	ISIO 200 (single unit)
VESC1601	ISIO 200 matched pair (2 preconfigured devices)

For further information about ISIO 200 please visit our website.

<sup>1</sup> The GOOSE functionality of the CMC requires software licences for the GOOSE configuration module

## DANEO 400: Distributed Hybrid Signal Analyzer



DANEO 400 is a hybrid measurement system that records and analyzes all conventional signals (voltages, currents, hard wired binary status signals) and messages on the communication network in a substation. It measures signals from both of these worlds and can provide information to assess their proper coordination. With this device it is easy to keep track of what is going on in the substation by obtaining information on the operational status and communication.

Easily configure and control one or more DANEO 400 with the PC software DANEO Control. For controlling a single device, a selected feature set is also available via the built-in DANEO 400 web interface.

### DANEO 400 covers a wide range of tasks in different applications

#### FAT or SAT scenarios in local substations

It is relevant to save recorded data and document measurement results at both factory and site acceptance tests (FAT, SAT). DANEO 400 verifies substation configuration language (SCL) information with the actual configuration "as found". It checks, if all GOOSE messages and Sampled Values streams are present on the network as defined in the substation configuration description (SCD). The SCD file serves as basis for the test.

#### Distributed testing in substation-to-substation scenarios

To verify proper inter-substation communication, it is possible to measure and assess the transfer of status information between substations with DANEO 400. The remote test sets are configured and controlled over the WAN.

#### Troubleshooting

The occurrence of malfunctions in substation automation systems is often not predictable. For this reason, DANEO 400 works autonomously and detects trigger conditions on its own for recording signals.

#### Commissioning

DANEO 400 is a valuable tool in the field of commissioning and helps to verify and document that all the commissioned protection and control devices are working and communicating properly.

### Ordering Information

Order number	Delivery contents
VESC1700	<b>DANEO 400 Basic</b> Signal Analyzer for Power Utility Automation Systems. Measuring and recording conventional (analog and binary) signals
VESC1701	<b>DANEO 400 Standard</b> Hybrid Signal Analyzer for Power Utility Automation Systems. Measuring and recording conventional (analog and binary) signals and traffic from power utility communication networks (GOOSE, Sampled Values,...).
VESC1711	<b>Upgrade</b> From DANEO 400 Basic to DANEO 400 Standard

For further information about DANEO 400 please visit our website.

## Maintenance Management Solution for Protection Systems

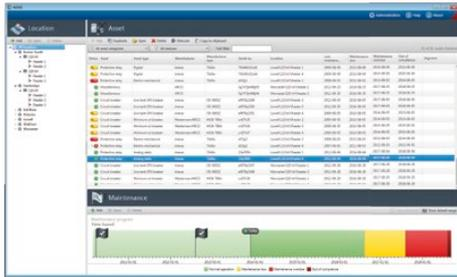

User interface

The testing and maintenance status of each individual component of protection systems significantly impacts the reliability of bulk electric systems. Therefore, proper testing of assets and regular maintenance are essential to keep the system in good working order. In addition, quick access to relevant test documentation is indispensable.

ADMO is an easy-to-use database software for central planning and management of all testing and maintenance activities for protection systems in the power industry. It supports users to manage protective relays, communication systems, control circuitry, current and voltage transformers, circuit breakers, station DC supplies, and energy meters.

For all assets managed with ADMO, the asset data, location, maintenance cycles and all associated test documents are stored. It provides an overview of all maintenance events that are currently due as well as the current maintenance status of the various assets.

### Central document management

When performing tests it is often important that manuals or other documents are easily accessible. ADMO supports storing of OMICRON Test Universe test data, third-party test documents and documents individually created in Microsoft Excel, asfsa Word or Adobe Acrobat (PDF) file formats. Graphic files (e.g., photos of tsfsafsafaup, screenshots) can also be attached. All allocated documents appear at the specific assets and are available at all the time.

### Location

Interaction between three levels are essential for ADMO: Location – Asset – Maintenance. Once a location is defined, assets can be added by entering the component-specific data and the appropriate maintenance cycles.

The hierarchically structured location management allows a clear representation of all relevant power stations and substations with their voltage levels and feeders. When a location is selected, ADMO gives an overview of the maintenance status of all assigned assets.

### Asset

System components to be added are assigned to a location and defined. The definition includes the precise data of the asset and its maintenance cycle. For the maintenance intervals individual settings can be selected. On completion of the input, the component appears in the overview with its current maintenance status.



Maintenance status

### Maintenance

The maintenance program view offers a time-related summary where users can see which tests were completed, scheduled or due. Everything is well-organized, recorded and easily visible at a glance, from commissioning to scheduled and performed maintenance events. Associated test reports and measurement results can be retrieved quickly and easily.

### Import/Export

For an initial data migration ADMO supports importing XML files from Microsoft Excel and OMICRON Primary Test Manager. Exporting asset data works into applications like Microsoft Word or Microsoft Excel.

### Multi-User access

The ADMO multi-user functionality allows users to work with ADMO from different locations simultaneously. The data is stored on a central SQL server and shared within the network.

### Ordering Information

Order number	Delivery contents
VESM2053	ADMO – Stand-Alone edition
VESM2054	ADMO – Client-Server edition (2 users) Further editions available on request

For further information about ADMO please visit our website.



OMICRON has a worldwide customer base which continues to grow. Direct customer contact is essential in developing and building lasting relationships around the world. To achieve this, OMICRON has an extensive network of more than 100 representatives, distributors and local offices.

To identify the contact for your area please visit the Contact section of our website at

**[www.omicron.at](http://www.omicron.at)** or  
**[www.omicronusa.com](http://www.omicronusa.com)**

OMICRON is an international company serving the electrical power industry with innovative testing and diagnostic solutions. The application of OMICRON products allows users to assess the condition of the primary and secondary equipment on their systems with complete confidence. Services offered in the area of consulting, commissioning, testing, diagnosis and training make the product range complete.

Customers in more than 140 countries rely on the company's ability to supply leading-edge technology of excellent quality. Service centers on all continents provide a broad base of knowledge and extraordinary customer support. All of this together with our strong network of sales partners is what has made our company a market leader in the electrical power industry.

The following publications provide further information on the protection testing solutions described in this catalog and on other secondary applications:



Testing Solutions for Protection Systems



Testing Solutions for Measurement Equipment

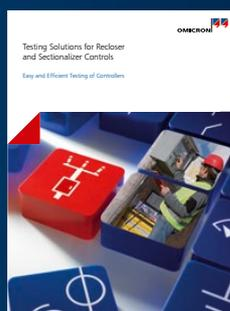

Testing Solutions for Reclosers and Sectionalizers

For more information, additional literature, and detailed contact information of our worldwide offices please visit our website.