

User Guide

**PFL22M1500**  
**PFL22M1500INV**  
**Megger Portable Cable Fault Locator**

**Note:** This User Guide is to be used in conjunction with  
MTDR300/100 User Guide ref: AVTMMTDR300

HIGH VOLTAGE EQUIPMENT  
Read this entire manual before operating.



**Megger.**

Valley Forge Corporate Center  
2621 Van Buren Avenue  
Norristown, PA 19403-2329  
U.S.A.

610-676-8500

*www.megger.com*



**Megger**

**PFL22M1500**  
FAULT LOCATING SYSTEM

**Megger**

**PFL22M1500-xx**  
**PFL22M1500INV-xx**

(xx is used to indicate Language specific model)

**Megger Portable Cable Fault Locator**

**Note: This User Guide is to be used in conjunction  
with  
MTDR300/100 User Guide ref: AVTMMTDR300**

**Copyright©2011 by Megger. All rights reserved.**

The information presented in this manual is believed to be adequate for the intended use of the product.  
The products described herein should not be used for purposes other than as specified herein.  
Specifications are subject to change without notice.

## WARRANTY

Products supplied by Megger are warranted against defects in material and workmanship for a period of one year following shipment. Our liability is specifically limited to replacing or repairing, at our option, defective equipment. Equipment returned for repair must be shipped prepaid and insured. Contact your local MEGGER representative for instructions and a return authorization (RA) number. Please indicate all pertinent information, including problem symptoms. Also specify the serial number and the catalog number of the unit. This warranty does not include batteries, lamps or other expendable items, where the original manufacturer's warranty shall apply. We make no other warranty. The warranty is void in the event of abuse (failure to follow recommended operating procedures) or failure by the customer to perform specific maintenance as indicated in this manual.

<b>Local Megger Offices</b>		
<b>Australia</b>	<b>Canada</b>	<b>France</b>
Megger Pty Limited Unit 1, 11-21 Underwood Road Homebush NSW 2140 T: +61 (0)2 9397 5900 F: +61 (0)2 9397 5911	110 Milner Avenue Unit 1 Scarborough Ontario M1S 3R2 Canada  T: 1 416 298 6770 F: 416 298 0848	23 rue Eugène Henaff ZA du Buisson de la Couldre 78190 TRAPPES T: 01 30 16 08 90 F: 01 34 61 23 77
<b>Germany</b>	<b>India</b>	<b>Kingdom of Bahrain</b>
Megger GmbH Obere Zeil 2 61440 Oberursel Deutschland  T: 06171-92987-0 F: 06171-92987-19	Megger (India) Pvt Limited 501 Crystal Paradise Mall Off. Veera Desai Road Andheri (W) Mumbai 400053 T: +91 22 26740468 F: +91 22 26740465	P.O. Box 15777 Office 81, Building 298 Road 3306, Block 333 Manama Kingdom of Bahrain. T: +973 177 40 620 F: + 973 177 20 975 mesales@megger.com
<b>Kingdom of Saudi Arabia</b>	<b>South Africa</b>	<b>Sweden</b>
PO Box 1168 Khobar 31952  T: +966 3889 4407 F: +966 3889 4077 mesales@megger.com	PO Box 22300 Glen Ashley 4022 Durban South Africa  T: +27 (031) 5646578 F: +27 (031) 5637990	Megger Sweden AB Eldarvägen 4 Box 2970 SE-187 29 TÄBY SWEDEN T: +46 8 510 195 00 F: +46 8 510 195 95
<b>Switzerland</b>	<b>United Kingdom (Dover)</b>	
Megger Schweiz AG Ob. Haselweg 630 5727 Oberkulm Aargau T: +41 62 768 20 30 F: +41 62 768 20 33	Megger Limited Archcliffe Road Dover CT17 9EN  T: 01304 502101 F: 01304 207342	
<b>United States (Dallas)</b>	<b>United States (Valley Forge)</b>	<b>United States (College Station)</b>
4271 Bronze Way, Dallas, Texas 75237-1019 USA  T: 1-800-723-2861 F: 1-214-331-7399	Valley Forge Corporate Centre 2621 Van Buren Avenue Norristown, PA 19403 USA T: 610 676 8500 F: 610-676-8610	4064 State Highway 6 South College Station, TX 77845 USA T: 979-690-7925 F: 979-690-0276

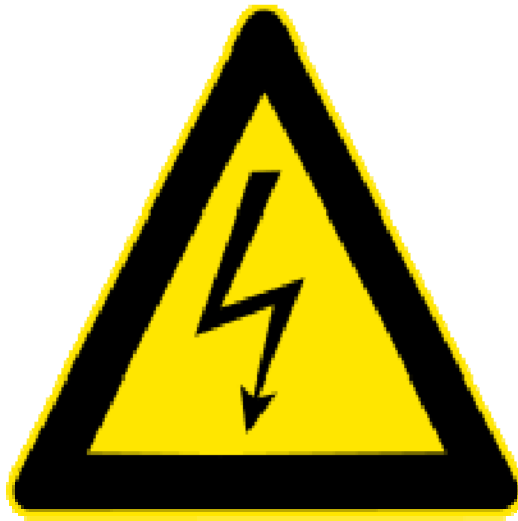

## **Safety**

Voltages of greater than 50 V applied across dry unbroken human skin are capable of producing heart fibrillation if they produce electric currents in body tissues which happen to pass through the chest area.[citation needed] The electrocution danger is mostly determined by the low conductivity of dry human skin. If skin is wet, or if there are wounds, or if the voltage is applied to electrodes which penetrate the skin, then even voltage sources below 40 V can be lethal if contacted. Additionally research has shown that where the skin has been compromised, very small voltage of up to 3V can kill.

Accidental contact with high voltage supplying sufficient energy will usually result in severe injury or death. This can occur as a person's body provides a path for current flow causing tissue damage and heart failure. Other injuries can include burns from the arc generated by the accidental contact. These can be especially dangerous if the victim's airways are affected. Injuries may also be suffered as a result of the physical forces exerted as people may fall from height or be thrown a considerable distance.

Low-energy exposure to high voltage may be harmless, such as the spark produced in a dry climate when touching a doorknob after walking across a carpeted floor.

# Table of Contents

1 SPECIFICATIONS .....	1
Supply.....	1
Input Voltage source .....	1
High Voltage .....	1
Proof / Burn Output.....	1
Surge Impulse (Voltage Impulse).....	2
Arc Reflection & Arc Reflection Plus .....	2
Modes of Operation .....	2
Low Voltage.....	2
MTDR 100 (Time Domain Reflectometer).....	2
Metering.....	3
Environmental.....	3
Dimensions & Weights .....	4
Accessories .....	4
Standard (supplied with instrument) .....	4
Optional (not supplied as standard) .....	5
2 GETTING TO KNOW YOUR PFF22M.....	7
Overview of Methods available on the PFL22M1500.....	7
TDR / Pulse Reflection .....	7
Arc Reflection.....	7
Arc Reflection Plus .....	7
Differential Arc Reflection (DART) .....	7
Impulse Current (ICE or Current Impulse) .....	7
Top Panel Controls.....	9
Metering.....	11
Controls .....	12
External Connections .....	14
External Connections .....	15
Integrated MTDR.....	16
3 SAFETY .....	17
General Safety Precautions .....	17
Handling Guidance .....	17
Safety in Using the PFL.....	20
4 PREPARING FOR TEST.....	21
Important Safety Warnings.....	21
Site Preparation.....	22
Making Connections .....	22
Earth (Ground) the Instrument .....	22
Incoming Supply Lead/Cord .....	23
HV Interlock blanking plug.....	23
Connection HV Cable .....	23
Sheath / Concentric connection .....	23
High Voltage Cable connection .....	23

Safety Zone .....	24
Switching On .....	24
Connection Diagram.....	24
<b>5 OPERATION OF THE PFL22M.....</b>	<b>25</b>
Test Modes .....	25
Connections .....	25
Switching on the unit.....	26
Test Procedures .....	26
D.C. Dielectric withstand (Proof) Test.....	26
D.C. Dielectric Proof/Burn.....	27
Arc Reflection : High Voltage Pre-location.....	28
Current Impulse (Surge Impulse, I.C.E.) : High Voltage Pre-location.....	30
Surge Generation (Surge Impulse): High Voltage pinpoint location.....	31
<b>6 MAINTENANCE .....</b>	<b>33</b>
<b>ADDENDUM 1 .....</b>	<b>35</b>
Specification .....	37
Protection .....	38
Operation .....	40
Determine Battery Capacity.....	40
Connect the Battery Cables .....	40
Cabling Guidelines .....	40
<b>ADDENDUM 2 .....</b>	<b>43</b>
Cable Fault Location Applications Guide .....	43
Typical Fault Locating Strategy .....	45
Overview of Fault Pre-location Methods.....	47
Description of TDR or Pulse Echo techniques.....	47
Description of Arc Reflection .....	48
Description of Impulse Current.....	49
Description of Voltage Decay .....	50



## UPON RECEIPT OF YOUR DELIVERY

Prior to operation, check for loosened hardware or damage incurred during transit. If these conditions are found, a safety hazard is likely, DO NOT attempt to operate equipment.

Please contact Megger as soon as possible.

Please check your delivery against:

- a) your order
- b) our advice note
- c) the item delivered, and
- d) the parts list

**Any shortages must be reported immediately.**

## **STANDARD MANUAL CONVENTIONS**

This manual uses the following conventions:

**Bold** indicates emphasis or a heading.

***NOTE:** is used to set off important information from the rest of the text.*



**A WARNING symbol alerts you to a hazard that may result in equipment damage, personal injury, or death. Carefully read the instructions provided and follow all safety precautions.**



**A CAUTION symbol alerts you that the system may not operate as expected if instructions are not followed.**

# 1

## SPECIFICATIONS

### *Supply*

#### **Input Voltage source**

- PFL22M1500-xxis fitted with automatic voltage switching and as such can be supplied from either, a) 108 to 135Volts or b) 208 to 265Volts supplies.
- The PFL22M1500-xx, maximum power requirement is 1500 VA when used with AC input. Two-pole three-terminal grounding type connector must be used.
- The PFL22M1500INV-xx has a 12V inverter installed allowing operation from a suitable 12V Supply, connected to the auxiliary connection on the side of the unit.
- The PFL22M1500INV-xx maximum power requirement of a 12V.d.c. power source is 1900 VA (160A), when used with the authorized inverter unit.

### *High Voltage*

#### **Proof / Burn Output**

<b>Output voltage</b>	0 to 10kV dc -ve
	0 to 20kV dc -ve
<b>Proof Current</b>	0 to 115mA (10V range)
	0 to 55mA (20kV range)
<b>Burn Current</b>	0 to 115mA (10V range)
	0 to 55mA (20kV range)

## Surge Impulse (Voltage Impulse)

Ranges	Two (2)
Impulse voltage	0 to 8kV 0 to 16kV
Impulse Energy @ 100% of range	1500joule @ 0 to 8kV 1500joule @ 0 to 16kV
Impulse Repetition Rate	Single Shot 5 to 30seconds

## Arc Reflection & Arc Reflection Plus

Voltage	0 to 8kV 0 to 16kV
Energy @ 100% of range	1500joule @ 0 to 8kV 1500joule @ 0 to 6kV
Traces:	1024 to 16 (Dependent on range selected)

## Modes of Operation

Low Voltage	Pulse Echo ; Direct; Comparison
High Voltage	Arc Reflection , Arc Reflection Plus (ARP), Differential Arc Reflection (DART) , Impulse Current

## Low Voltage

### MTDR 100 (Time Domain Reflectometer)

Operation	Single Jog-Dial
Modes	Pulse Echo, Direct, Comparison, Arc Reflection, Arc Reflection Plus (ARP), Differential Arc Reflection (DART) Impulse Current
Ranges	10 ranges: 100m, to 55km ; 328ft to 180,445ft

## SPECIFICATIONS

---

<b>Pulse Width</b>	50ns, 100ns, 200ns, 500ns 1 $\mu$ s, 2 $\mu$ s, 5 $\mu$ s, 10 $\mu$ s
<b>Pulse Amplitude</b>	25V into 50 Ohms
<b>Sampling Rate</b>	100Megasamples/sec
<b>Resolution (VP=55%)</b>	0.82m / 2.7ft
<b>Timebase accuracy</b>	200 ppm
<b>Output impedance</b>	50 Ohms
<b>Gain</b>	Variable over 60dB in 5dB steps
<b>Display</b>	XGA 1024 x 768 : 26.5mm (10.4")
<b>Storage</b>	On-board and USB

### Metering

<b>Voltmeter</b>	Analogue 0 to 20kV Accuracy 5%
<b>Ammeter</b>	Analogue 0 to 300mA Accuracy 5%

### Environmental

<b>Operating Temp</b>	-20 to 50° C / -4 to 120 °F
<b>Storage Temperature</b>	-30 to 55° C / -22 to 131°F
<b>Humidity</b>	5 to 95% RH non-condensing (operating)
<b>Elevation</b>	1600m (De-rate voltages at higher altitudes)

## ***Dimensions & Weights***

Height	965 mm / 38 inch
Width	536 mm / 21inch
Depth	503 mm / 20 inch
Weight (Total)	131kgs / 290lbs

## ***Accessories***

### **Standard (supplied with instrument)**

<b>High Voltage Cable</b>	15m flexible, lightweight,40kV single core HV cable	1001-123:
<b>Safety Ground Cable</b>	15m flexible ground cable with ferrules,	19265-15:
<b>Input/supply Cable</b>	line cord/ supply cable (1 x ea)	17032-4 ; North American 17032-5 ; International 17032-12; BS 170032-13; EU SHUKO
<b>Shorting plug</b>	Interlock shorting plug qty 1 supplied	10226-1
<b>Cable Bag/Satchel</b>	Cable bag to take all cables	2001-813:
<b>Documentation</b>	User Guide	AVTMPFL22:
<b>Software</b>	Cable Analysis Software	CAS-1:

**Optional (not supplied as standard)**

<b>HV Vice Groups</b>	Adjustable HV Vice Grips	18944-2
<b>PFL22M Transit Case</b>	Transit Case	2001-289
<b>HV Discharge stick</b>	70kV Discharge stick	222070-62
<b>12 V External Battery</b>	12V/92Ah Battery	1001-690
<b>Discharge Receiver:</b>	Acoustic and Electromagnetic pinpoint receiver	MPP2000

**Cable Drums**

Megger have several cable drums and cable drum assemblies which need to be specified dependent on installation and possible combination with other instruments. Another consideration is where the equipment is installed into a vehicle or trailer the available payload must be taken into consideration.

It is recommend that the factory is contacted prior to ordering the optional cable drums or cable drum assemblies

**Megger.**



# 2

## GETTING TO KNOW YOUR PFF22M

### *Overview of Methods available on the PFL22M1500*

#### TDR / Pulse Reflection

**Reminder:** TDR or Pulse Echo is a low voltage method of fault pre-location suitable for locating short and open circuits and other faults below about 300Ohm. It is not suitable for high impedance or flashing faults, where HV method should be used.

#### Arc Reflection

**Reminder:** Arc Reflection is the most widely HV method of fault Pre-location used. It is suitable for high resistance, flashing and other faults that can be ignited by a surge generator. A reference trace is taken without the arc, and then a real-time trace is taken during the arc and recorded and compared to the reference trace. The point of divergence is the fault position.

#### Arc Reflection Plus

**Reminder:** As Arc Reflection but with the added advantage of being able to view multiple traces, all of which have been captured during the period of the arc. This removes the need to adjust the triggering time, as all stages of the arc can be interrogated.

#### Differential Arc Reflection (DART)

**Reminder:** In Differential Arc Reflection mode unwanted and confusing reflection are removed leaving a clean trace with only the fault position being displayed by a positive pulse. This method is especially suited in locating high-resistance faults in complex cable systems”.

#### Impulse Current (ICE or Current Impulse)

**Reminder:** Impulse current whilst being suitable for long or wet cables, it is by far the most difficult requiring the most interpretation. The fault is ignited and the resultant transients are recorded on a transient recorder. The trace displays

## Megger.

---

negative impulse both at the point of fault (low impedance) and also where the surge generator is connected to the cable. Do not use the first displayed impulse as this includes the “ionization delay” i.e. the time needed for the fault to flashover. The distance between the negative going impulses is the distance to fault. For added accuracy try using more than one measurement and different voltages!

## Top Panel Controls

### Safety

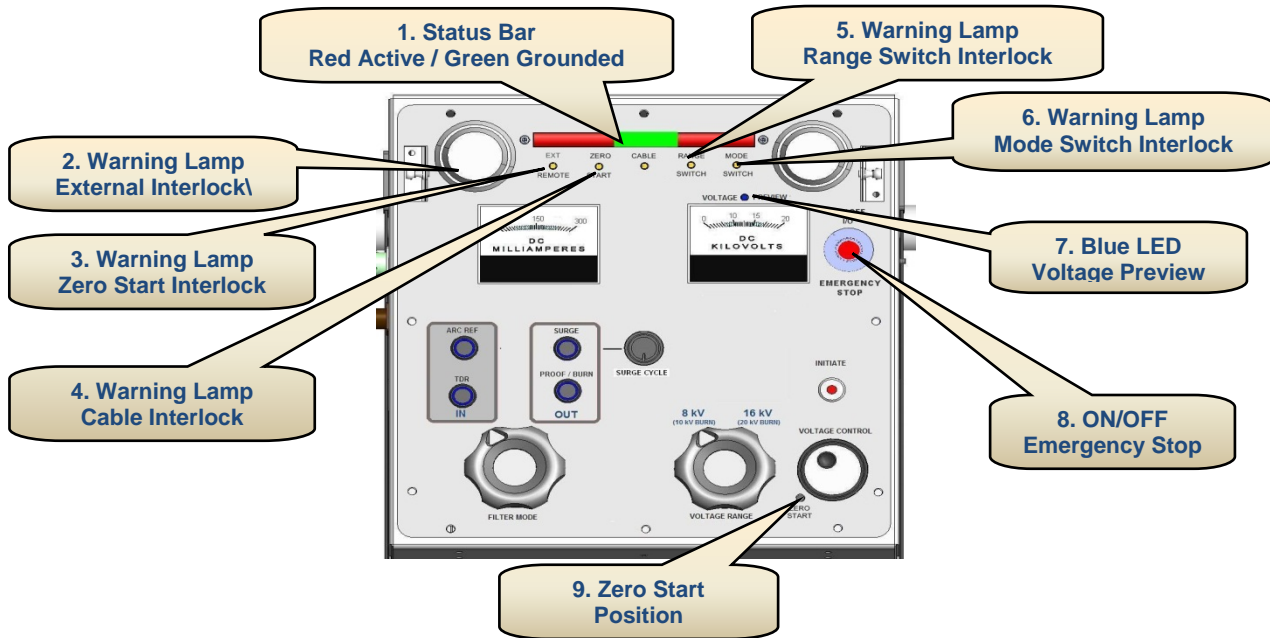

- |  |  |
|--|--|
| <p><b>1. Status Bar:</b> Indicates HV On / HV Off</p>  | <p>High visibility status bar Indicates Operating status of the PFL22.</p> <p>Ungrounded / HV On: Two outer segments glow Red indicating earth/ground off and HV active.</p> <div style="border: 1px solid black; padding: 5px; margin: 10px 0;"> <p><i>Note: HV not active in TDR mode</i></p> </div> <p>Grounded / HV Off: Single inner segment glows Green indicating Earths are on with no HV present.</p> |
| <p><b>2. External Interlock LED (Yellow):</b> Indicates if External Interlock activated</p>  | <p>When illuminated indicates that the optional external interlock has been activated, or interlock blanking-plug not in place.</p>  |
| <p><b>3. Zero Start Interlock LED (Yellow):</b> Indicates of voltage control not at zero</p> | <p>When illuminated indicates that the voltage control knob is not at zero, Voltage control must be at zero before commencing any voltage changes. Only active for dc operations.</p>  |

# Megger.

---

- |  |   |
|--|---|
| <b>4. HV Cable Interlock LED</b><br><u>(Yellow)</u> : Indicates HV Cable not connected         | When illuminated indicates that the HV cable connection to the PFL has not been made correctly.   |
| <b>5. Range Switch Interlock LED</b><br><u>(Yellow)</u> : Indicates if Range Switch not seated | Illuminates if the Range switch is not properly seated, and a range correctly selected.   |
| <b>6. Mode Switch Interlock LED</b><br><u>(Yellow)</u> : Indicates if Mode Switch not seated   | Illuminates if the Mode selector switch is not properly seated, and a mode correctly selected.  |
| <b>7. Voltage Preview LED</b><br><u>(Blue)</u> : Preview of voltage to be applied              | When illuminated this indicates that the voltage shown on the Kilovolt meter is a preview only, prior to it being applied to the cable under test. (No HV activated)                              |
| <b>8. Emergency Stop</b>   | This switch acts as an Emergency Stop and also an On/Off switch. To disengage and turn on the instrument pull this switch. To turn off either in an emergency or when operation complete depress. |
| <b>9. Zero Start</b>   | Voltage control must be at zero before commencing any voltage changes. Only active for dc operations.   |

## Metering

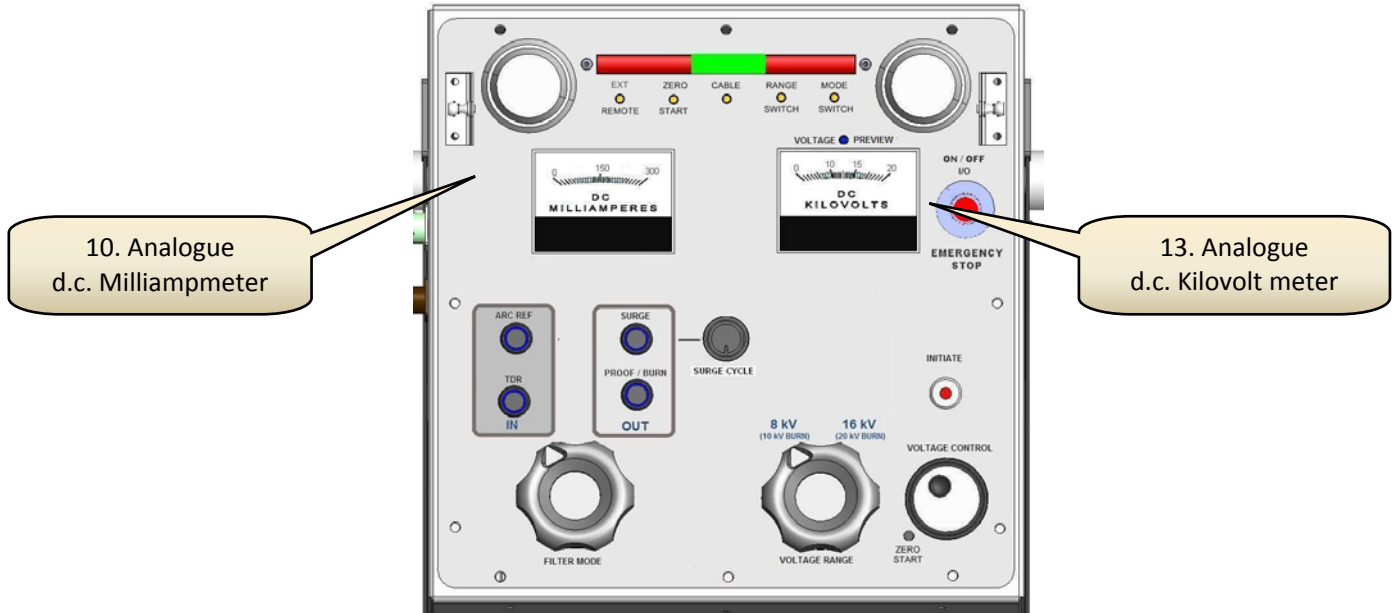

**10. Milliampmeter:**

0 to 300mA analogue Mili-Amp meter. Indicates the charging current being applied (leakage current).

**11. NOT USED**

**12. NOT USED**

**13. d.c. KiloVolt meter:**

0 to 20 kV analogue kilovolt meter. Indicates applied voltage (or voltage preview) in Proof/Burn, Surge, Arc Reflection modes.

## Controls

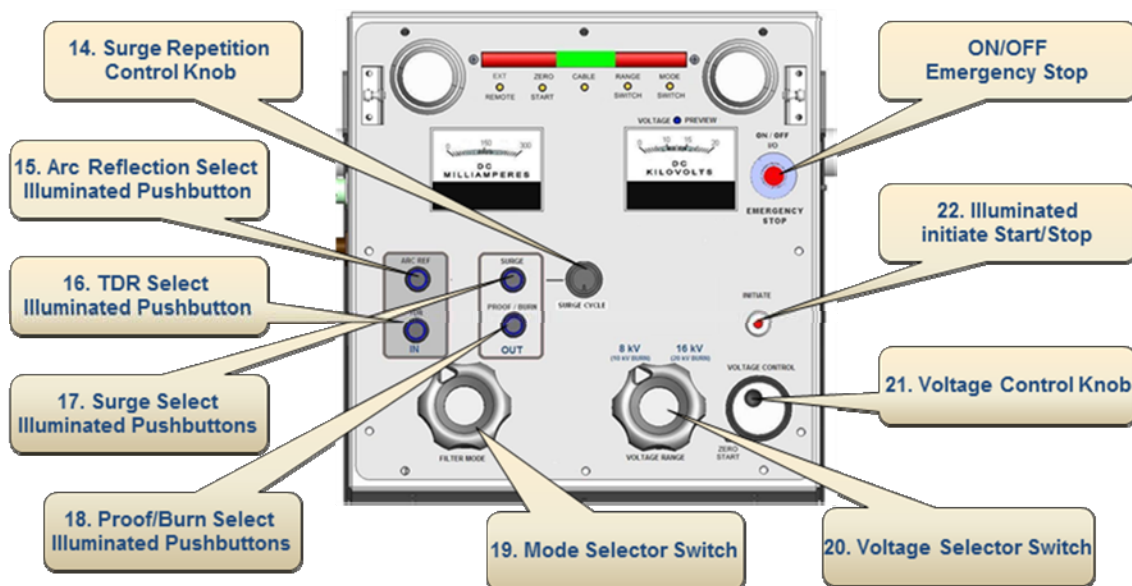

- 14. Surge Repetition Control Knob:** Select either single shot or set the desired surge repetition rate.
- 15. Arc Reflection Mode Pushbutton (switch/indicator):** To selected Arc Reflection mode depress the push button switch. The switch will illuminate indicating Arc Reflection mode selected and active.
- 16. TDR Mode Pushbutton switch/indicator:** To select TDR (Pulse Echo) depress the push button switch. The switch will illuminate indicating TDR mode selected and active.
- 17. Surge Mode Pushbutton (switch/indicator):** To select Surge or Impulse Current depress the switch. The switch will illuminate indicating Surge mode selected and active.
- 18. Proof/Burn Mode Pushbutton (switch/indicator):** To select Proof/Burn depress the switch. The switch will illuminate indicating Proof/Burn mode selected and active.
- 19. Mode Switch**  
Two position rotary selector switch. Switch between the mode groups: Arc Reflection & TDR and Surge & Proof/Burn.

- 20. Voltage Range Switch:** Two position rotary selector switch that switches between the proof/burn ranges of 10 & 20 kV and the surge voltage ranges of 8 & 16 kV.
- 21. Voltage Control Knob:** Rotary Voltage control knob, controlling the applied voltage in Proof/Burn, Surge or Arc Reflection modes. Control is via a zero start, hence before selecting knob must be at zero. Only active for dc operations.
- 22. Initiate pushbutton:** Push button whereby the HV is activated
- a) In Proof/Burn. When the pushbutton is depressed it will flash on and off (green) indicating that the HV is active.
  - b) In Surge or Arc Reflection modes. When the pushbutton is depressed the output will be initiated. i.e. there will be a surge..

## **External Connections**

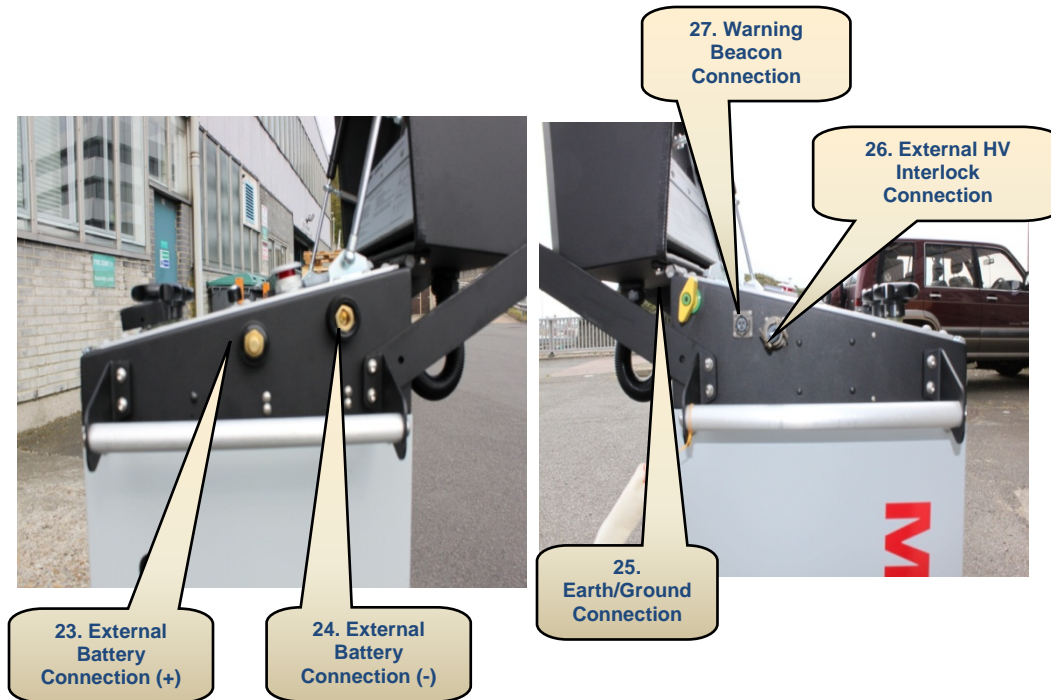

**23. External Battery connection  
Positive (+):**

The positive connection point when using the PFL22M from an external 12V supply.

**24. External Battery connection  
Negative (-):**

The negative connection point when using the PFL22M from an external 12V supply.

**25. Earth/Ground connection:**

Note: When external battery is used the only earth/ground is via the external Earth/Grounding connection (item 25)

The instrument Earthing/Grounding point. For operator safety it is mandatory that the PFL22M is efficiently earthed/grounded. Failure to do so could result in serious injury or in the extreme circumstances death.

**26. External HV interlock:**

To provide additional operator safety an external HV interlock (optional accessory) can be fitted.

**27. Warning Beacon connection:  
(Removed on later models)**

Through this connection an external warning beacon (optional accessory) can be fitted. Connection rated at 3A, 220V dc and 250V ac, exceeding this limit will damage the unit.



## External Connections

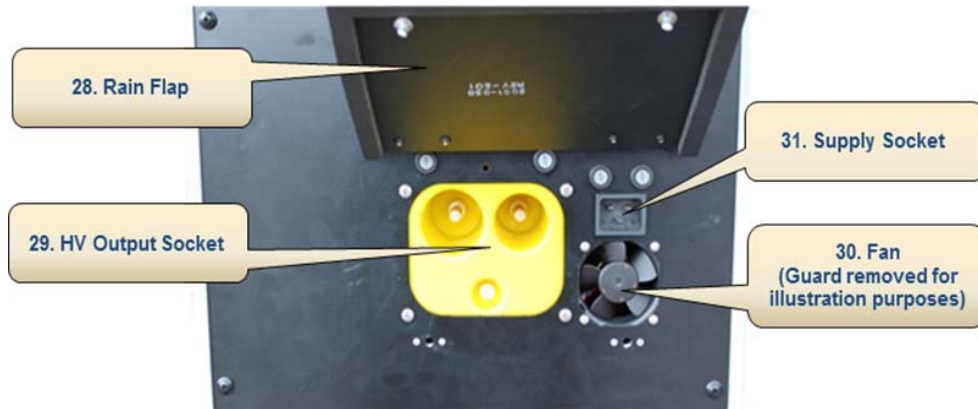

### 28. Rain Flap

Closed and secured during transportation to maintain Instrument IP rating.

### 29. HV Output Socket

The PFL22M is supplied with a 5m detachable 40kV HV cable. Interlocks built into the receptacle inhibit the use of the unit unless the HV cable is securely fitted.

### 30. Fan

(Guard/Cover removed for illustration purposes)

### 31. Supply Socket

PFL22M1500 is fitted with automatic voltage switching and as such can be supplied from either 108 to 135Volts or 210 to 265Volts.

## ***Integrated MTDR***

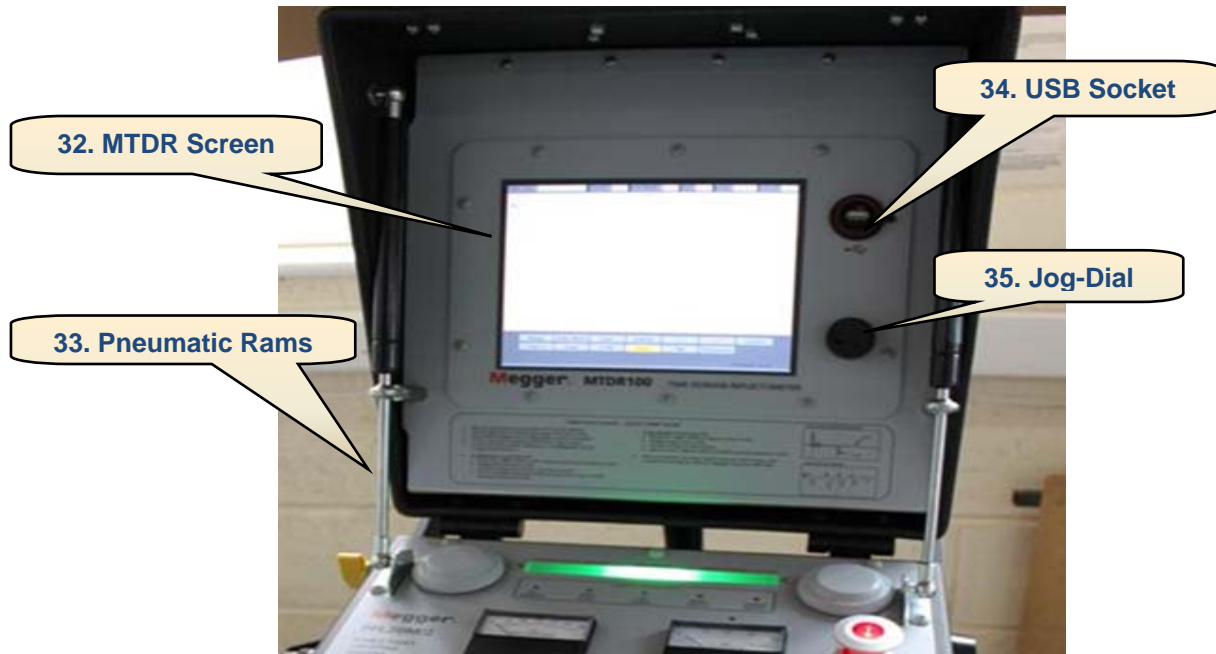

- 32. MTDR Display**      Large 21cm (10.4”) LCD display. Displaying all parameters and the necessary information and traces to achieve rapid accurate fault location.
  
- 33. Pneumatic Lid Rams:**      Pneumatic support rams provide safe support whilst opening and closing the lid of the PFL22M.
  
- 34. USB Port:**      USB port to download/upload memorized traces including all parameters.
  
- 35. MTDR Jog Dial:**      One-button operation of the MTDR is achieved using the Rotary Jog-Dial control knob. With this jog-dial the operator sets all the preferences, selects modes of operation and undertakes the fault analysis and fault pre-location.

# 3

## **SAFETY**

***Safety is the responsibility of the user***

### ***General Safety Precautions***

Local Operating Company Safety Standards and Instructions should always be followed, the following are for guidance only.

#### **Handling Guidance**

##### ***IMPORTANT***

*Due to the overall weight and size of the PFL22M1500, it is not designed for manual lifting or carrying. Any lifting should be undertaken with appropriate mechanical equipment, preferably on a level, stable secure platform that can accommodate the wheels and the base of the unit.*

*For manoeuvrability the PFL22M1500 is supplied on a robust wheel-kit with a large handle. These wheels and handle allows the instrument to be pushed or pulled onto site. For uneven or un-level ground, where pushing could become difficult, additional handles are fitted to the top and bottom side panels, whereby additional persons may assist moving the PFL22M1500 onto its required operating position.*

*These guidelines do not take precedence over the operator Companies own guidelines on handling heavy equipment, which must take precedence.*

The PFL22M1500 should only be used for its stated application. Any other application may render the safety features inoperative and expose the operator to dangerous levels of energy.

In the event of equipment malfunction, the unit should immediately be de-energized and returned to Megger for repair.

This equipment generates High Voltages and high Current, which can be lethal.

Operators must read and understand this entire User Guide prior to operating the equipment. Operator must follow the instructions of this User Guide and attend the equipment while the equipment is in use.

Only “**Competent**” or “**Authorized**” personal should operate the PFL22M1500 system.

**Authorized Person:** means a person recognized by an Authorizing Officer as having sufficient technical knowledge to perform certain duties in respect of defined electrical systems and equipment. An Authorized Person is normally appointed in writing by an Authorizing Officer.

Authorized Persons are those individuals who manage the Code and then ensure compliance with the Rules. The limit of responsibility may in general be different for each Authorized Person and must be detailed in writing. The level of responsibility will depend on the ability, experience, and on the extent and nature of the equipment under the control of the Authorized Person.

**Competent Person:** means a person having:-

- Adequate knowledge of electricity
- Adequate experience of electrical work
- An understanding of the system to be worked on and practical experience of that class of system
- An understanding of the hazards which may arise during the work, and the precautions which need to be taken
- The ability to recognise at all times whether it is safe for work to continue

<p><i>Note: If persons are not competent to undertake particular work on their own, for example those who have not completed their training, then they must be accompanied and supervised by a competent person.</i></p>
--

- Observe all safety warnings on the equipment, and provided in this manual.
- Use this equipment only for the purposes described in this manual.

- Do not use the equipment in rain or snow unless in sheltered position.
- Do not operate the equipment whilst standing in water.
- All terminals of H.V. equipment are potential electric shock hazards. Use all safety precautions to prevent contact with energized parts of the equipment and related circuits.
- Use suitable barriers, barricades, or warnings to keep persons not directly involved with the work away from test activities.
- Never connect the test equipment to energized cables or use in explosive atmosphere.
- Use the grounding and connection procedures recommended in this manual.
- Personnel using heart pacemakers should obtain expert advice on the possible risks before operating this equipment or being close to the equipment during operation.

## ***Safety in Using the PFL***

**Never assume that either the PFL22M1500 High Voltage Output Cable or the Cable Specimen is de-energized. Always treat exposed conductors and connections as potential electric shock hazards.**

**The PFL22M1500 and the Cable under test are both sources of instantaneously lethal levels of electrical energy.**

- Do not use this equipment to locate faults on any cable that may be close enough to an energized cable to allow a burn-through of the insulation of the energized cable.
- Do not operate the PFL if it has not first been stabilized and in an upright position.
- Remain a safe distance from all parts of the High-Voltage circuit, including all connections, unless the equipment is de-energised and all parts of the test circuit are earthed/grounded. Be aware that any voltage applied to the Cable Specimen will be present at the remote end(s) and at any other exposed part of the cable, often out of sight of the operator.
- Use the grounding and connection procedures. If other manufacturers' equipment is used with the PFL, the user is responsible for verifying that the grounding and interconnections between the systems comply with each Manufacturer's Instructions.
- Use Industry Accepted practices for making reliable, low-impedance connections, capable of carrying large surge currents.
- Maintain adequate air clearances between the exposed High-Voltage conductor and any adjacent grounds to prevent spark-over. An uncontrolled spark-over can create a safety hazard.
- Megger recommends the use of appropriately rated rubber gloves when connecting and disconnecting to the High-Voltage terminals.
- An Interlock circuit is provided (and its use is highly recommended) to enable the operator to safely control access to the complete high-voltage circuit.

# 4

## PREPARING FOR TEST

### **IMPORTANT SAFETY WARNINGS**

#### WARNING



The surge return is isolated from chassis ground by a 2000ohm resistor. This limits current in the case of a failed concentric neutral.

The surge return cannot be used as a substitute system ground.

Failure to follow this procedure can result in serious injury or in the extreme, death of the operator and/or the destruction of the equipment.

#### WARNING



The operator is isolated from transient voltages along the surge return by the insulation system in the PFL and by the insulated jacket of the high voltage output cable. Tears or breaks in the insulating jacket of the High-Voltage output cable expose the Surge Return to the operator and poses a safety hazard and the cable should be replaced.

#### WARNING



**DO NOT EXTEND** the Surge Return lead of the HV Output Cable because this introduces excessive impedance in the Surge Return and could result in exposed hazardous voltages.

## ***Site Preparation***

Choose a location that meets the following conditions:

- The vehicle (if used) can be safely parked. Set the brakes or block the wheels.
- The location is as dry as possible.
- There is no flammable material stored in the vicinity.
- The test area is adequately ventilated.
- Both the High-Voltage conductor and the Shield of the Cable Specimen are accessible. Be sure all equipment is de-energized. Identify the faulted cable, obtain access to both ends, and erect safety barriers to protect the operator from traffic hazards and to prevent intrusion by unauthorized personnel. Beacon Warning lights are recommended.
- Verify that the station ground is intact and presents an impedance of **LESS** than 100 milliohms to earth/ground.

## ***Making Connections***

Before operating the PFL22M1500 the following connections and safety procedures need to be followed.

- Ensure the cable to be tested is Earthed/Grounded and de-energized.
- Connect the Earthing/Grounding cable of the PFL22M1500 to a suitable Earth/Ground point and the Earth/Ground stud on the PFL22M1500.
- Connect the supply cord to the PFL22M1500 and suitable supply.
- Connect the HV Interlock blanking plug (unless using external interlock).
- Connect the detachable HV cable to the PFL22M1500.
- Connect the Sheath of the HV cable to the cable under test.
- Connect the HV connection of the HV cable to the cable under test.
- Cordon off a safety zone around instrument and all exposed cable terminations.

## **Earth (Ground) the Instrument**

Prior to operating the PFL22M1500 or making any other connections the instrument has to be Earthed/Grounded. This is achieved by connecting the supplied Green & Yellow Earth /Ground lead to the Earth/Ground terminal on the side of the instrument directly to a clean metallic Earth/Ground. If in doubt use an Earth/Ground Tester to confirm status of Earth/Ground. It is not sufficient just to rely on the supply earth/ground as this may not exist.



### **Incoming Supply Lead/Cord**

The appropriate (Country specific) PFL22M1500 supplied supply lead/cord should be inserted into the receptacle at the rear of the instrument (under the protective rain flap) and connected to a suitable stable supply in the range of a) 108 to 135Volts or b) 210 to 265Volts. Do not use extension leads, unless suitably rated.

The maximum power consumption for the PFL22M1500 is 1500 VA when used with AC input. Power consumption is approximately 1900 VA (160A) of 12 VDC power when used with the authorized inverter unit.

### **HV Interlock blanking plug**

Attach the HV interlock blanking plug to the external HV interlock connection on the right hand side of the instrument. Not required when optional HV switch used.

### **Connection HV Cable**

The Large Yellow HV cable termination of the HV Cable is inserted into the HV Output socket at the rear of the PFL22M1500. Care should be taken to ensure that the HV cable connection interlock (part of HV output socket) is engaged. It is impossible to turn on the HV if no HV cable is connected.

### **Sheath / Concentric connection**

Before undertaking this connection you should check to ensure that the cable under test is Earthed/Grounded, if unable to do so it is dangerous to make any connection to it.

The Sheath / Concentric connection of the HV Cable is connected to the sheath/concentric connection of the cable under test with the supplied HV Clip.

### **High Voltage Cable connection**

Before undertaking this connection you should check to ensure that the cable under test is Earthed/Grounded, if unable to do so it is dangerous to make any connection to it.

The HV Core connection of the HV Cable is connected to the core of the cable under test with the supplied HV Clip.

## Safety Zone

As High Voltages are present when undertaking cable testing and cable fault location any area of potential danger needs to be cordoned off to protect people from possible “electrical shock”. This includes the cable terminations, point of connection and other areas of potential hazard.

## Switching On

Once all connections have been made and a safety zone established the PFL22M1500 can be turned-on, by pulling out the emergency stop button which also acts as an on/off switch.

During turn-on all lamps will illuminate for a short period (self check), but no High Voltage is present or available until selected.

## Connection Diagram

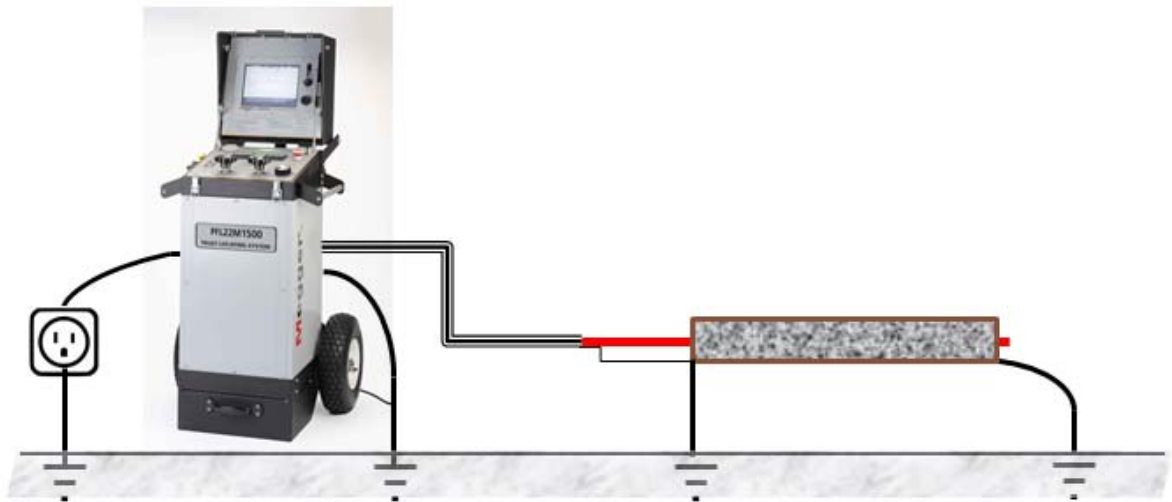

*Note: If the PFL22M1500 is mounted in a vehicle or trailer the vehicle or trailer should be grounded/earthed. The PFL22M1500 should then be grounded to the vehicle. You must not ground the PFL22M1500 directly, if it is mounted in a vehicle.*

# 5

## OPERATION OF THE PFL22M

### *Test Modes*

The PFL22M1500 system provides the User with the following testing and cable fault locating modes:

- D.C. Dielectric Withstand (Proof)
- D.C. Proof/Burn
- Pulse Echo (Time Domain Reflectometer, TDR) Low Voltage Pre-location
- Arc Reflection - High Voltage Pre-location
- Arc Reflection Plus (ARP) - High Voltage Pre-location
- Differential Arc Reflection (DART) - High Voltage Pre-location
- Impulse Current (Surge Impulse, I.C.E.) - High Voltage Pre-location
- Surge (Surge Impulse) - High Voltage pinpoint location

### *Connections*

All connections shall be made and safety procedures followed as per Sections 2 and 3.

## Switching on the unit

1. Turn on the PFL22M1500 by pulling out the yellow Emergency Stop button (item 8) which also acts as an on/off switch. At turn-on all lamps will illuminate for a short period of time, during self test.

<i>Note:</i> <i>The Voltage and Mode selector switches are locked in position during transportation to help avoid miss-handling. Therefore they cannot be moved or turned until the unit is turned on. Additionally once a mode has been selected these switches are locked.</i>
--

2. Assuming all interlocks are satisfied the Status Bar (item 1) will glow “Green” and all Interlock lamps will remain off. If any of the interlocks are not satisfied the lamps will glow yellow.

## Test Procedures

### D.C. Dielectric withstand (Proof) Test

The PFL22M1500 generates a dc test voltage of 0 to 20 kV –ve with a current of 0 to 115 mA (10kV range) and is used to test the integrity of cable installations. The test voltage is defined by the user and local regulations.

1. Set the rotary Voltage Control knob (item 21) to the “Zero Start” (item 9) position.

<i>Note:</i> <i>Range and function switch cannot be moved if a mode is active.</i>
--

2. Set the Voltage Range switch (item 20) to the desired range either 10 or 20kV. At this stage the Status Bar (item 1) will glow “Red”
3. Set the Mode selector switch (item 19) to Proof-Burn & Surge. Both lamps will illuminate, advising that either of these modes are available.
4. Depress the pushbutton of the desired mode, in this case Proof/Burn. Selection is confirmed by the pushbutton remaining illuminated and other pushbutton extinguishing.

Initiate button Illuminates.

5. The required test voltage is set by using the Voltage Control knob (item 21). This voltage is displayed on the d.c Kilovolt meter (item 13) and the voltage Preview Lamp (item 7) is illuminated indicating that the displayed voltage is a “preview only” with no HV being applied at this time.

6. Depress the Initiate button (item 22) and the selected test voltage will be applied to the cable under test. Whilst active the pushbutton will flash.

The integrity of the cable under test can now be assessed by reviewing a) breakdown voltage and b) leakage current.

7. To deselect, depress the Proof/Burn pushbutton (item 18), which also engages the internal earthing/grounding and removes any High Voltage.
8. At this stage the Status Bar (item 1) will glow “Green”.

### D.C. Dielectric Proof/Burn

1. Set the Voltage Control Knob (item 21) to the “Zero Start” position (item 9).

<i>Note: Range and function switch cannot be moved if a mode is active.</i>
---

2. Set the Voltage Range switch (item 19) to the desired range either 10 or 20kV. At this stage the Status Bar (item 1) will glow “Red”
3. Set the Mode selector switch (item 19) to Proof-Burn & Surge group. Both lamps will illuminate, advising that either of these modes are available.
4. Depress the pushbutton of the desired mode, in this case Proof/Burn. Selection is confirmed by the pushbutton remaining illuminated and other pushbutton extinguishing.  
  
Initiate button Illuminates.
5. The required test voltage is set by using the Voltage Control knob (item 21). This voltage is displayed on the d.c Kilovolt meter (item 13) and the Voltage Preview Lamp (item 7) is illuminated indicating that the displayed voltage is a “preview only” with no HV being applied at this time.
6. Depress the Initiate button (item 22) and the selected Proof/Burn voltage will be applied to the cable under test. When active the pushbutton will flash
7. If the fault needs conditioning (burning) then the operator leaves the proof/burn voltage applied, rather than removing it which would be the normal practise when checking the integrity of the cable. Following a suitable period as defined by the operator the voltage is removed.
8. To deselect, depress the Proof/Burn pushbutton (item 18), which also engages the internal earthing/grounding and removes any High Voltage.
9. The Status Bar (item 1) will glow “green” when all HV is removed and the instrument and test piece has been earthed/grounded.

## Pulse Echo (Time Domain Reflectometer, TDR) : Low Voltage Pre-location

The PFL22M1500 has an integrated T.D.R.

1. Set the rotary Voltage Control Knob (item 21) to the “Zero Start” position (item 9).

**NOTE:** *Range and function switch cannot be moved if a mode is active.*

2. Ensure that the Voltage Range switch (item 20) is fully depressed. As we are using TDR (low voltage pre-location) no HV voltage is required. At this stage the Status Bar (item 1) will glow “Red”
3. Set the Mode selector switch (item 20) to the TDR and Arc Reflection group. Both lamps will illuminate, advising that either of these modes are available.
4. Depress the pushbutton of the desired mode, in this case TDR. Selection is confirmed by the pushbutton remaining illuminated and the other pushbutton extinguishing.
5. **For instructions on the use of the TDR refer to Addendum \*\*\* MTDR100 User Guide**
6. To deselect, and terminate operation depress the TDR pushbutton (item 16), which also engages the internal earthing/grounding.
7. The Status Bar (item 1) will glow “Green”.

## Arc Reflection : High Voltage Pre-location

**Also Arc Reflection Plus (ARP) and Differential Arc Reflection (DART)**

1. Set the rotary Voltage Control Knob (item 21) to the “Zero Start” position (item 9).

**NOTE::** *Range and function switch cannot be moved if a mode is active.*

2. Set the Voltage Range switch (item 20) to the desired “surge” range either 8 or 16kV. At this stage the Status Bar (item 1) will glow “Red”.
3. Set the Mode selector switch (item 19) to the TDR and Arc Reflection group. Both lamps will illuminate, advising that either of these modes are available.
4. Depress the pushbutton of the desired mode, in this case Arc Reflection. Selection is confirmed by the pushbutton remaining illuminated and the other pushbutton extinguishing.

5. On the MTDR select the Arc Reflection method and a standard Pulse Echo measurement is made, with the trace being automatically stored in the internal memory. This is your reference trace.
6. The MTDR is armed (made ready) by selecting “ARM” from the menu buttons. The word “armed” is displayed on the MTDR.
7. **For FULL instructions on the use of the TDR refer to Addendum \*\*\* MTDR100 User Guide.**
8. The required “Impulse or Surge” voltage is set by rotating the Voltage Control knob (item 21) to the required voltage, which is normally slightly higher than the voltage that the fault broke down at. The selected voltage is displayed on the d.c Kilovolt meter (item 13) the Voltage Preview lamp (item 7) is illuminated indicating that the displayed voltage is a “preview” with no HV being applied.
9. Depress the Initiate button (item 22) and the impulse or surge voltage is applied to the cable under test.

By observing the Voltmeter and Ammeter the operator can confirm that there has been a full discharge.

Normally in Arc Reflection only one discharge is required; hence the Surge Repetition Control knob (item14) is set to single shot.
10. The resultant trace on the MTDR is recorded and overlaid with the original (reference) pulse echo trace. The point of divergence of the two traces, with the arc reflection trace going negative of the two traces indicates the location of the fault.

If operation “fails to trigger”, increase voltage and repeat operation

If operation fails and no point of divergence can be found, repeat operation.

<p><i>NOTE     The features; Arc Reflection Plus (ARP) and Differential Arc Reflection (DART), how to configure and there benefits are contained in the <b>MTDR100 User Guide</b> .</i></p>
---

11. To deselect depress the arc reflection pushbutton. The Status Bar (item1) will glow “green” when all HV is removed and the instrument and test piece has been earthed/grounded.

## Current Impulse (Surge Impulse, I.C.E.) : High Voltage Pre-location

1. Set the rotary Voltage Control Knob (item 21) to the “Zero Start” position (item 9).
2. Set the Voltage Range switch (item 20) to the desired “surge” range either 8 or 16kV. At this stage the Status Bar (item 1) will glow “Red”.

*NOTE: Range and function switch cannot be moved if a mode is active.*

3. Set the Mode selector switch (item 19) to the Surge and Proof Burn group. Both lamps will illuminate, advising that either of these modes are available.
4. Depress the Surge Mode pushbutton of the desired mode. Selection is confirmed by the pushbutton remaining illuminated and the other pushbutton extinguishing.
5. On the MTDR, select Current Impulse.
6. The MTDR is armed (made ready) by selecting “ARM” from the menu buttons. The word “armed” is displayed on the MTDR.

### **For FULL instructions on the use of the TDR refer to MTDR300/100 User Guide AVTMMTDR300**

7. The required “Impulse or Surge” voltage is set by rotating the Voltage Control knob (item 21) to the required voltage, which is normally slightly higher than the voltage that the fault broke down at. The selected voltage is displayed on the d.c Kilovolt meter (item 13) the Voltage Preview lamp (item 12) is illuminated indicating that the displayed voltage is a “preview” with no HV being applied.
8. Set the Surge Repetition control (item 14) to the desired repetition rate from single shot or 3secs to 30sec.
9. Depress the Initiate button (item 22) and the impulse or surge voltage is applied to the cable under test, and the resultant waveform on the MTDR can be analysed to determine the fault position.

*Note: By observing the Voltmeter and Ammeter the operator can confirm that there has been a full discharge.*

If operation “fails to trigger”, increase voltage and repeat operation.

To deselect depress the Surge pushbutton (item 17), which also engages the internal earthing/grounding and removes any High Voltage.

The Status Bar (item 1) will glow “green” when all HV removed and the instrument and test piece has been earthed/grounded.



---

**Surge Generation (Surge Impulse): High Voltage pinpoint location**

1. Set the rotary Voltage Control knob (item 21) to the “Zero Start” position (item 9).
2. Set the Voltage Range switch (item 20) to the desired “surge” range either 8 or 16kV. At this stage the Status Bar (item 1) will glow “Red”.

**NOTE:** *Range and function switch cannot be moved if a mode is active.*

3. Set the Mode selector switch (item 19) to the Surge and Proof Burn group. Both lamps will illuminate, advising that either of these modes are available.
4. Depress the Surge Mode pushbutton (item 17). Selection is confirmed by the pushbutton remaining illuminated and the other pushbutton extinguishing.
5. Set the Surge Repetition Control (item 14) to the desired repetition rate from 3secs to 30sec. The rate selected is decided by the operator based on conditions i.e. external noise and ease of hearing the discharges via the ground microphone.
6. Select the required voltage using the rotary Voltage Control knob (item 21). The selected voltage being displayed on the d.c Kilovolt meter (item 13) the Voltage Preview lamp (item 7) is illuminated indicating that the displayed voltage is a “preview” with no HV being applied.
7. Depress the Initiate button (item 22) and the selected impulse voltage is applied to the cable under test at the required rate as set by the surge cycle control.

The fault is then located using the acoustic method and a suitable impulse receiver (MPP2000).

8. To deselect depress the Surge Mode pushbutton (item 17), which also engages the internal earthing/grounding and removes any High Voltage.
9. The Status Bar (item 1) will glow “green” when all HV removed and the instrument and test piece has been earthed/grounded.

**Megger.**

# 6

## MAINTENANCE

Due to the nature of the PFL and the high voltages and energy levels present in the instrument, it is recommended that any maintenance is undertaken by a Megger Authorized Service Center.

Operators should inspect all connections and cables prior to operation, and in the event of damage should either make-good locally or repair them for repair via the Megger Authorized Service Center route.

In the event that Service is required, contact your Megger representative or local Megger Authorized Service Center for instructions, a product Return Authorization (RMA) number, and shipping instructions.

When reporting any failures or issues please have available all pertinent information, including catalogue number, serial number, and symptoms of problem.

Typical Information that will assist us:-

1. Model Number and Serial Number of the equipment?
2. Voltage and frequency of supply.
3. Was the unit connected via an extension lead/cord?
4. Was there an earth/ground connection in the supply?
5. Was the unit correctly earthed/grounded?
6. What was the type of test being undertaken when unit failed?
7. What was being tested, including length and voltage rating?
8. Any other information on what was being tested that you think will help us.
9. What was the first indication of the failure? (smoke, smell warning message)
10. Any other unusual signs or indications?

## **Megger.**

---

11. How long had the unit been operating before it failed?
12. Local conditions: i.e. weather, temperature, humidity, dust, etc.
13. Contact details of operator, or who to contact to follow-up.

# Addendum 1

## **PFL22M1500INV-XX**

(PFL22M1500INV Inverter Option only)

**Megger.**

---

## This section applies to PFL22M1500's fitted with *optional* Inverter Only

### Caution



The installed inverter “must only be connected” to a battery that has a nominal output of 12V, it will not operate if connected to a 6V battery and will be damaged if connected to a 24V battery

### Specification

#### DC Input

Input power:	2400VA (max at full load)
Input Current:	200A (max at full load)
Input voltage range:	10.5 – 15.5V d.c.
Low battery alarm:	Audible, 11V
Low battery cut-out:	10.5V

#### AC Output

Peak Power:	2000W (5-mins)
Continuous Power:	1800W
Surge Power:	2000W
Output Current:	15A continuous 19.2A (max)
Output Voltage	120V a.c. RMS $\pm 5\%$
Output Voltage Range:	104 – 127V a.c.
Output Waveform:	True Sinewave
Output Frequency:	60Hz $\pm 5$ Hz

## ***Protection***

The Inverter is equipped with the following protection features:

<b>GFCI Protection:</b>	De-energizes the AC circuits and thereby protects the user and equipment if a ground fault occurs. The Ground Fault Interrupter (GFCI) protects against hazardous electrical shocks that could be caused by dampness, faulty mechanism worn insulation and similar phenomena.
<b>Low Battery alarm:</b>	Alerts the operator if the battery has become discharged to 11V or lower.
<b>Low Battery shutdown:</b>	Automatically shuts the inverter down if the battery voltage drops below 10.5V.
<b>High Battery shutdown:</b>	Automatically shuts down the inverter if the input voltage rises to more than 15.5V
<b>AC Output overload:</b>	Shuts down the inverter automatically if a short circuit occurs or if the load exceeds the operating limits.
<b>Over temperature:</b>	Turns the inverter off if its temperature rises above an acceptable level.



---

**In the event of any of the protection circuits operating use the following procedures:**

1. Remove batteries cables from the batteries, short together the batter cable clips, and then re-connect the batteries to the PFL.

In the event this does not work, it is highly likely that the GFCI protection has tripped

2. **GFCI tripped:** To re-set the GFCI control take a long screwdriver and push the reset button which is accessed through the hole in the side of the PFL's wheel kit.

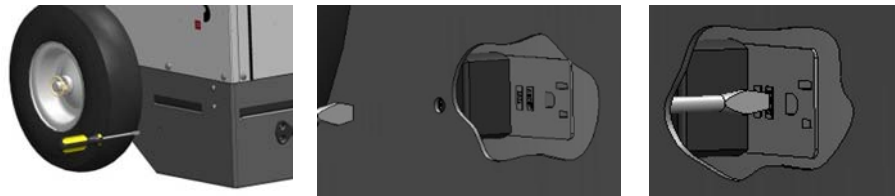

3. **Low Battery alarm:** Turn-off the unit, replace or re-charge batteries
4. **Low Battery shutdown:** If the voltage has recovered above 11.5V the unit will switch on.

If it doesn't recover, after five minutes the system will shut down.

Replace or re-charge batteries up to correct operating voltage

5. **High Battery shutdown:** If the voltage falls to below 15.5V the unit will switch on.

If it doesn't recover, after five minutes the system will shut down.

Use batteries of correct rating.

6. **AC Output overload:** Shuts down the inverter automatically if a short circuit occurs or if the load exceeds the operating limits.

Remove batteries cables from either the batteries or PFL and re-connect

7. **Over temperature:** Allow the unit to cool down and re-energise. If after five minutes of operating in high temperature, the unit turns itself off.

## Operation

### CAUTION



**A reverse polarity connection (positive to negative) will blow a fuse in the inverter and may permanently damage the unit. Damage caused by a reverse polarity connection is not covered by warranty.**

### Determine Battery Capacity

Battery type and size affects the performance of the inverter and PFL. We recommend that for optimum power as much battery capacity as possible is used.

### Connect the Battery Cables

To operate safely and effectively the inverter needs proper DC cables to be used between the battery and battery connection posts on the PFL. Because the inverter has low-voltage and high-current input, low resistance wiring between the battery and the inverter is essential to deliver the maximum amount of usable energy to the PFL.

### Cabling Guidelines

- Use 4AWG copper (90°C insulation rating) as the smallest battery cable size. This will minimise the voltage drop between the battery and the PFL. If the cable causes an excessive voltage drop, the inverter will shut down when drawing higher currents because the inverter input drops below 10.5V.
- Keep all cables as short as possible, and ensure that each cable between the battery and PFL is no longer than 6ft (1.8m).
- Ensure all wires and cables are terminated correctly, with appropriate sized connectors.
- Do not use aluminium as it has about 1/3 more resistance than copper cable of the same size. Additionally it is difficult to make good low-resistance connections to aluminium wire.

### WARNING



#### **Do not complete the next step if:**

- a) **inflammable fumes are present, explosion or fire may results.**
- b) **the PFL is connected to mains supply.**

- 
1. Connect the cable from the positive terminal on the PFL to positive terminal of the battery. Make a secure connection, loose connectors cause excessive voltage drop, may cause overheated wires and melted insulation.
  2. Attached the cable from the negative terminal on the PFL to the negative terminal of the battery. You may observe a spark when making this connection.
  3. Turn-on the PFL in the normal way.

**Megger.**

## **Addendum 2**

### ***Cable Fault Location Applications Guide***

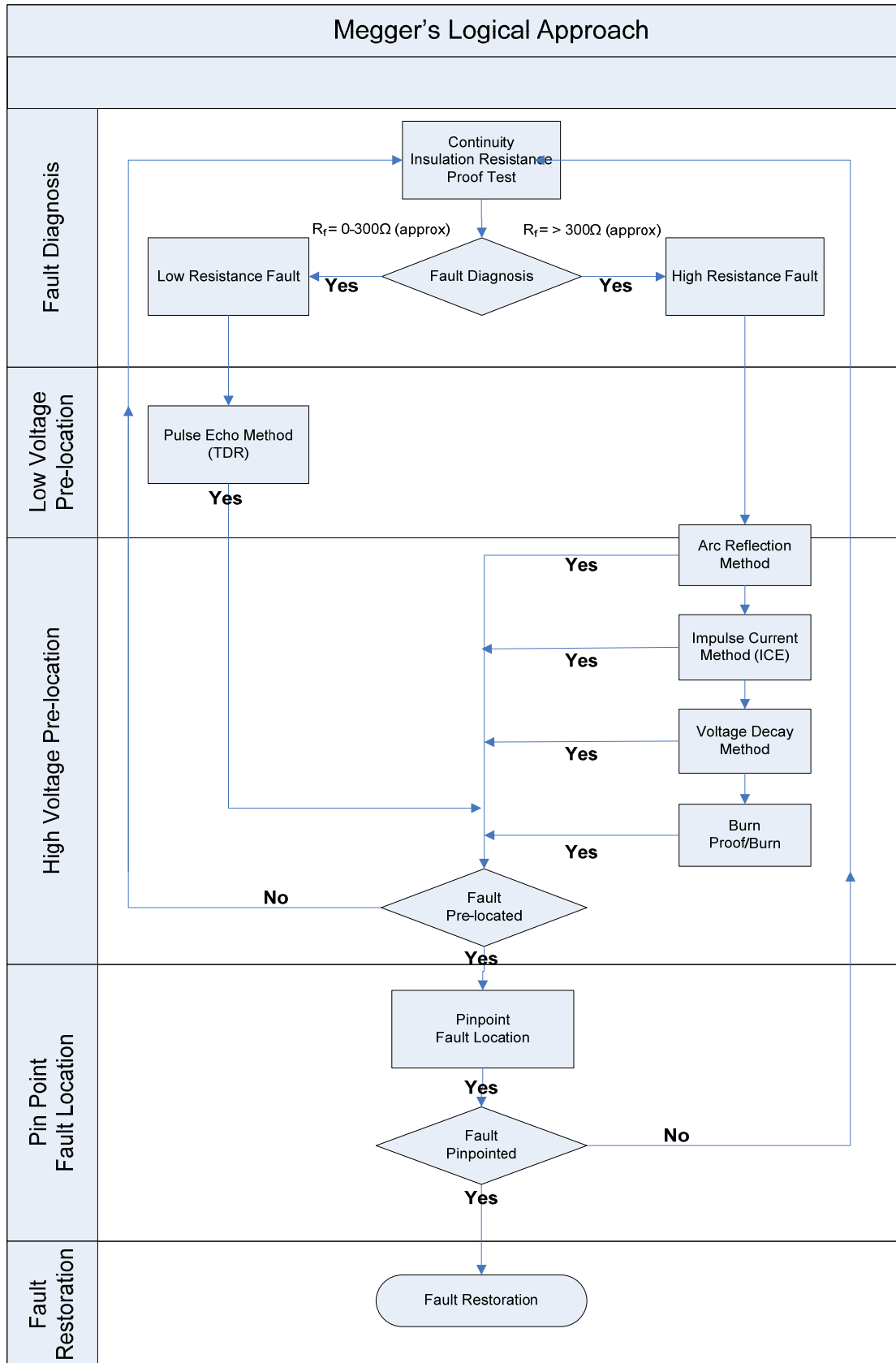

# A2

## Remember !

**“It’s your fault if you don’t find the fault”**

**and**

**“It’s your Fault if you do”**

## Typical Fault Locating Strategy

The most important aspect of locating a cable fault is the development of a strategy that will allow the fault location to be safely and positively identified.

This is achieved by following the Megger **“Logical Approach to Fault Location”** See previous flowchart.

1. Use only suitably rated, equipment, making sure that all company and equipment manufacturers' safety guidelines are followed.
2. Positively identify the faulted cable. Following isolation and Earthing/Grounding of all of the suspect cables and cores, this can be done by either using an Insulation Continuity Tester, to determine the condition of each of the cables and cable cores, or by using a TDR to see if all of the cores appear to have the same characteristics, i.e. (splices, joins, transformers, etc., at approximately the same distance.
3. If all circuit elements appear to be equal, determine if the electrical length of the circuit elements agree with the known physical length of the circuit. If it does not verify, then adjust the TDR propagation velocity accordingly.
4. If the TDR data is inconclusive, use the d.c. (Proof/Dielectric Test) function to positively identify the faulted phase. Separately bring each phase up to a test voltage as agreed by “local” conditions or regulations. Note the breakdown voltage from the faulty phase or phases.
  - a. After the faulted phase (or phases) has been positively identified, begin pre-location by engaging the Arc Reflection method and configuring the MTDR and PFL for Arc Reflection. Apply a test

voltage as defined by the breakdown voltage noted during the previous step. Increase the test voltage slowly, noting that the longer the cable, the greater the cable capacitance, hence the Arc Reflection breakdown voltage can be higher than the breakdown voltage. If the fault appears to be unstable, try increasing the discharge voltage slightly.

- b. If the fault does not consistently breakdown, or is unstable, at the maximum allowable voltage, select the Proof/Burn function on the PFL. Raise the voltage to either the maximum allowable voltage or until the fault breaks down in a relatively stable manner as indicated by stable current and voltage. Continue this proof/burn function until the discharge current is stable, after a few minutes of stable discharge, return to Arc Reflection. Do not use proof/burn excessively as you could create a “dead short” to earth/ground that would be extremely difficult, if not impossible to pinpoint using acoustic methods.
- c. Another effective method of HV Pre-location is the Impulse Current method also known as Impulse Surge, or Voltage Surge. This method is effective for pre-locating high-resistance faults (arc resistance greater than 200 $\Omega$ ) where the Arc Reflection method does not work effectively. The Impulse Current method is similar to the Arc Reflection method in that both methods send high energy pulses down the cable which are used to break down the fault. When using the Impulse Current method, a current coupler is switched into the surge return circuit and is used to measure the high frequencies transients, seen as a series of spikes each separated by the time taken for the transients to travel time from the fault back to the PFL.

It should be noted that the first displayed pulse includes the “ionisation delay” and should not be used for measurement. In general, the second or third pulses can be used. Later pulses can distort the measurement as they have been attenuated by the cable during the multiple reflections.

- d. Once the fault has been pre-located by using any of the above methods, the fault can be pinpointed either by acoustic or electro-acoustic methods. Set the PFL to Impulse Current and set the discharge voltage to a voltage similar to that used previously. Note: The lowest possible voltage should be used (as long as it is high enough to ignite the fault and create a flashover) as this ensures that the maximum energy is available, making pinpoint location easier. Set the discharge rate as desired and use the MPP2000 pinpoint receiver to pinpoint the exact location of the fault.



---

## Overview of Fault Pre-location Methods

### Description of TDR or Pulse Echo techniques

TDR also known as Pulse Echo or radar methods of fault location use low-voltage pulses to locate changes in impedance along the length of the cable.

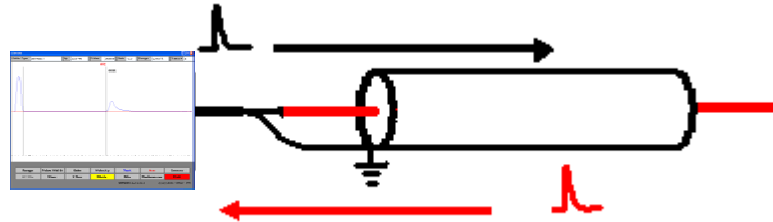

From these low-voltage pulses, a small amount of energy is reflected back to the TDR from a change of impedance and is displayed on the MTDR screen, as either a positive going or negative going pulse, depending on the impedance characteristic (negative pulse for low impedance to shield faults and positive pulse for high resistance faults).

With Pulse Echo, the time which the pulse needs to travel from the Instrument to the end of cable and back is measured by means of a cursor which is positioned at the beginning of the reflection.

Mathematical representation:  $L = v \cdot t$

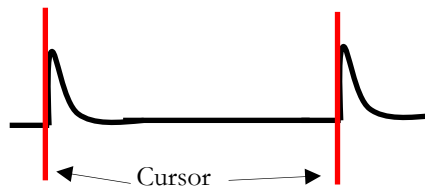

With Pulse Echo, the output pulse travels twice the distance of the cable. i.e. from the output of the TDR to the change of impedance and the returning reflection back to the TDR.,

so the length to the impedance change is shown as:  $L_x = v \cdot t / 2 = v / 2 \cdot t$

Where:  $v$  = Propagation velocity;  $L$  = Measured length;  $t$  = time measured

## Description of Arc Reflection

The Arc Reflection method uses standard pulse echo techniques to prelocate high resistance faults, which are not identifiable using pulse echo.

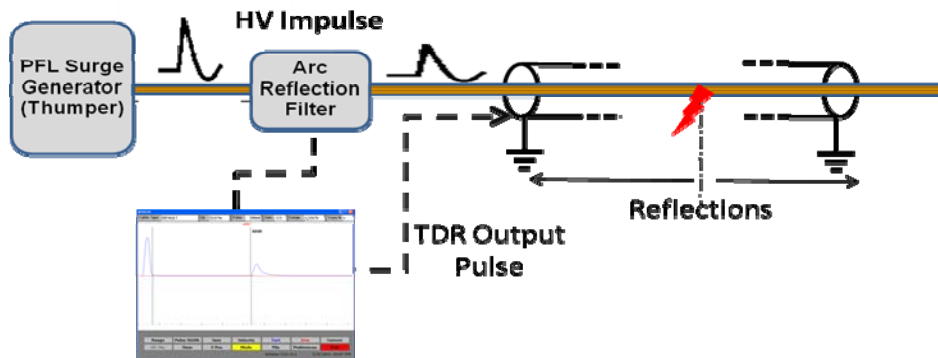

In Arc Reflection we use an Impulse Generator, Arc Reflection Filter and the MTDR100. The operator takes a standard pulse echo trace which is automatically saved as a reference file. Then a HV impulse is applied to the cable, the impulse going through the Arc reflection filter. This arc reflection filter “stretches” in time, the outgoing pulse which then ignites the fault, creating a temporary bridge to earth/ground. During this period the MTDR sends out LV TDR pulses into what is in effect a short circuit. This trace is then memorised and compared to the original trace. The point of divergence is the point of fault.

### Typical Traces

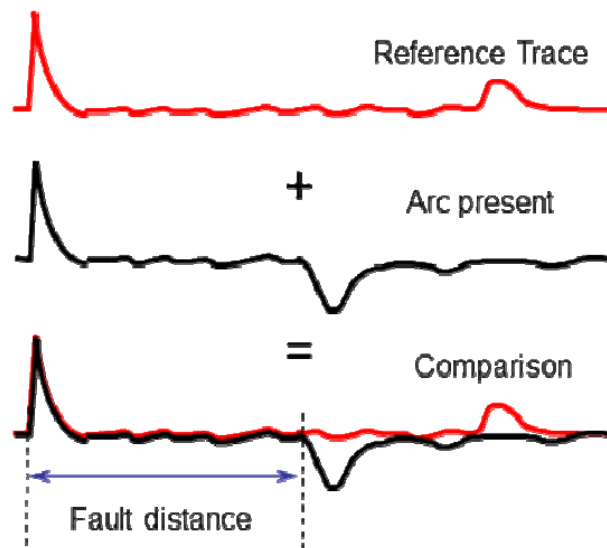

This method is extremely effective and easy to interpretation.

---

## Description of Impulse Current

Impulse current also known as ICE is probably one of the oldest methods of fault Pre-location using “transient analysis”. This method allows the pre-location of high resistance and flashing faults.

In Impulse Current we use an Impulse Generator, Inductive Coupler (C.T.) and the MTDR100 which acts like a transient recorder. The surge generator creates a flashover at the point of fault and the resultant transients are reflected back and forward between the fault and the impulse generator. These transients are picked-up by the Inductive couple and fed to the MTDR where they are subsequently displayed.

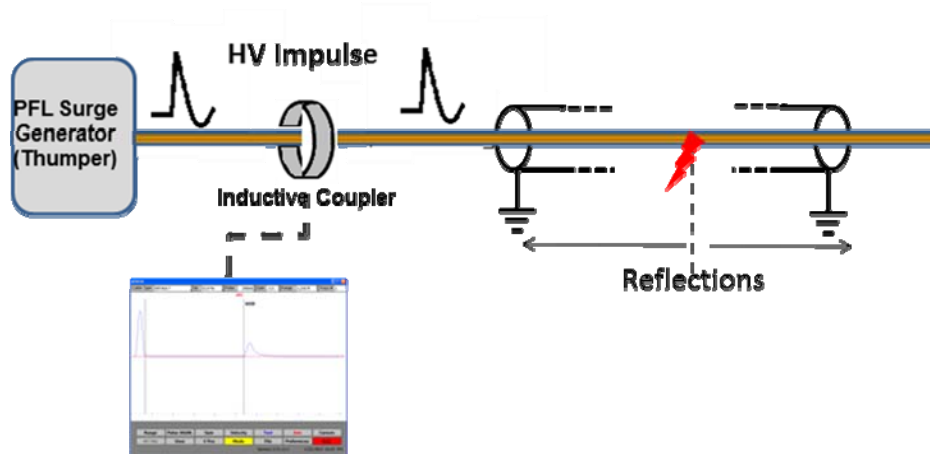

### Typical Trace

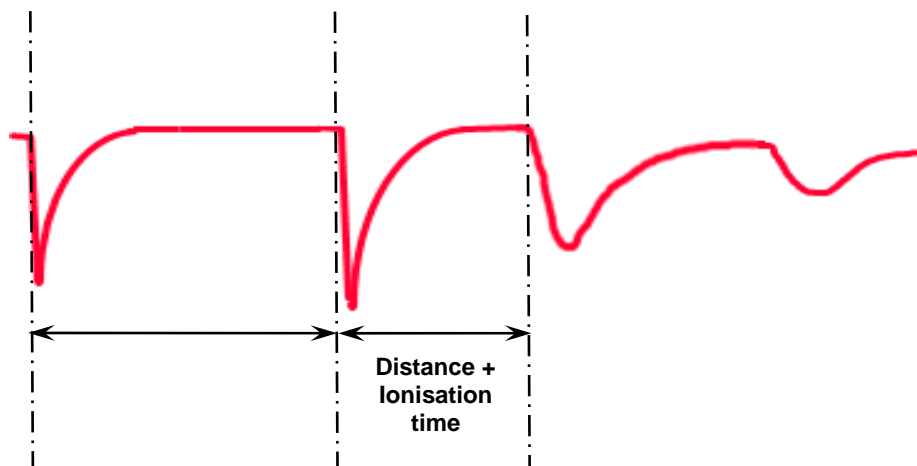

## Description of Voltage Decay

Voltage Decay is probably only used around 8% of the time, but it is especially useful when a fault breaks down and then reseals itself. This can be termed a “flashing or pecking” fault. Voltage decay can also be used where the voltage required to breakdown the fault cannot be achieved with the surge generator.

In Voltage Decay we typically use a High Voltage d.c. source, a voltage divider and the MTDR100 which is operating as a transient recorder.

HV DC is applied and the voltage increased until the fault breaks down, and a flashover occurs. During this flashover (the point of fault) the resultant transients are reflected back and forward between the fault and the dc source. These transients are detected by the voltage divider and fed to the MTDR where they are subsequently displayed.

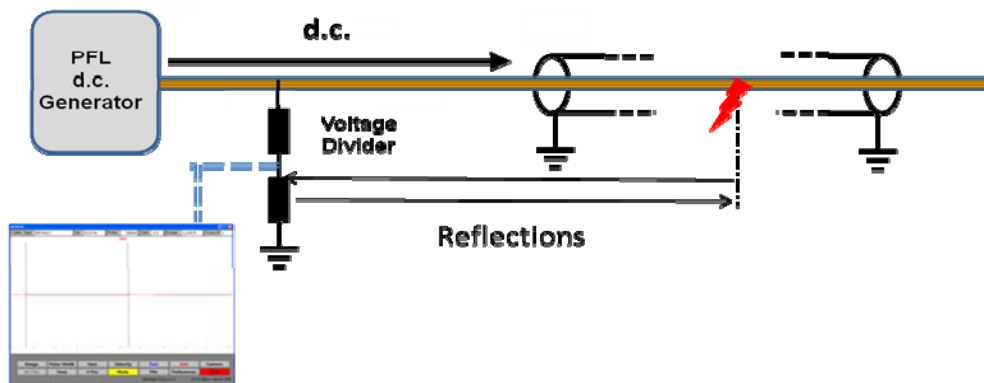

Typical Trace

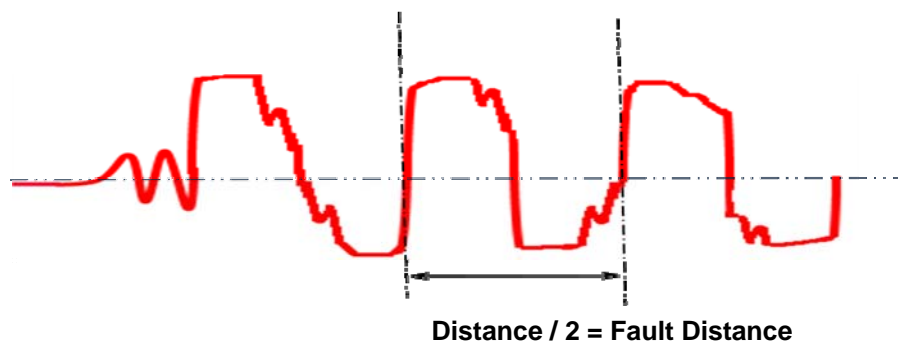

---

# Megger PFL22M1500-xx Certificate



## EC Declaration of Conformity

We certify and declare the listed product and found that it conforms to the applicable portions of the EMC Directive 2004/108/EC based on the following specifications applied:

- Standards** ▶ EN55011:2009/A1:2010  
Group 1, Class A
- EN61326-1:2006 Table 2  
For use in Industrial Locations
- Product Approved** ▶ Power Cable Fault Locator, 0-20kV DC, 1.5kJ max.  
PFL22M1500-EN 120V/230V @ 50/60 Hz  
PFL22M1500INV-EN 12 V DC
- Date of Approval** ▶ April 12, 2012
- Authorized manufacturer representatives:
- Quality Assurance Manager** ▶   
Robert Runta
- Engineering Manager** ▶   
George Esmet
- Certificate No** ▶ EMC22M

Valley Forge Corporate Center  
2621 Van Buren Avenue  
Norristown, PA 19383-2329 USA  
T 610-675-8500  
[www.megger.com](http://www.megger.com)  
Registered to ISO 9001:2008

---

---

**Megger Quality System Certificate**



Affiliate with the N.V. KEMA in The Netherlands



**CERTIFICATE**

Certificate Number: 110006.01

The Quality System of:

**Megger®**  
**2621 Van Buren Ave**  
**Norristown, PA 19403**  
**United States**

Including its implementation, meets the requirements of the standard:

**ISO 9001:2000**

Scope:

Design, manufacturing and marketing of electrical, electronic and mechanical measuring instruments and systems.

This Certificate is valid until: February 13, 2013  
This Certificate is valid as of: February 13, 2010  
Certified for the first time: January 1, 1995

H. Pierre Sallé  
President  
KEMA-Registered Quality

The method of operation for quality certification is defined in the KEMA General Terms And Conditions For Quality And Environmental Management Systems Certifications. Integral publication of this certificate is allowed.

---

KEMA-Registered Quality, Inc.  
4377 County Line Road  
Chalfont, PA 18914  
Ph: (215)997-4519  
Fax: (215)997-3809  
CERT 001 042 004

Accredited By:  
ANAB



Experience you can trust.



Affiliate with the N.V. KEMA in The Netherlands



# CERTIFICATE

Certificate Number: 110006.01

The Quality System of:

**Megger®**  
**2621 Van Buren Ave**  
**Norristown, PA 19403**  
**United States**

Including its implementation, meets the requirements of the standard:

## ISO 9001:2008

Scope:

Design, manufacturing and marketing of electrical, electronic and mechanical measuring instruments and systems.

This Certificate is valid until:	February 13, 2013
This Certificate is valid as of:	February 13, 2010
Certified for the first time:	January 1, 1995

H. Pierre Sallé  
President  
KEMA-Registered Quality

The method of operation for quality certification is defined in the KEMA General Terms And Conditions For Quality And Environmental Management Systems Certifications. Integral publication of this certificate is allowed.

**KEMA-Registered Quality, Inc.**  
4377 County Line Road  
Chalfont, PA 18914  
Ph: (215)997-4519  
Fax: (215)997-3809  
CR1601 04/08

Accredited By:  
ANAB



Experience you can trust.

**Megger.**