User's Manual

CW240 Clamp-on Power Meter

IM CW240E

Index

Introduction	1
Checking the Contents of the Package	2
Precautions for Safe Use of the Instrument	6
Utilisation en Toute Securite	9
Chapter 1 Product Overview	1-1
1.1 Product Overview	1-2
1.2 System Configuration Diagram	1-4
Chapter 2 Part Names and How to Use Parts	2-1
2.1 Front Panel and Connector Block	2-2
2.2 Operation Keys	2-3
2.3 Side Faces	2-4
2.4 Screen Configuration	2-5
2.5 Overrange/Error Indication during Measurement	2-6
2.6 Description of Mark Indication	2-11
Chapter 3 Preparation for Safe Measurements	3-1
3.1 Precautions for Use	3-2
3.2 Connecting a Power Supply	3-4
3.3 Connecting Voltage Probes	3-14
3.4 Connecting Clamp-on Probes	3-15
3.5 Connection Diagrams of Voltage Probes and Clamp-on Probes	3-17
3.6 Turning ON the Power Switch	3-22
3.7 Performing Measurements with Greater Precision	3-24

Chapter 4	Wiring	4-1
4.1	Precautions for Wiring to the Measurement Circuit	4-2
4.2	Installing the CW240	4-3
4.3	Setting up Wiring	4-5
4.4	Setting up the Number of Loads	4-6
4.5	Carrying out Wiring	4-7
4.6	Wiring the Measurement Circuit	
	Using External VT/CT	4-23
4.7	Checking Wiring	4-24
Chapter 5	Setting Ranges Using the Direct Keys... 5-1	
5.1	Setting the Voltage Range	5-2
5.2	Setting the Current Range	5-4
5.3	Ranges and Number of Digits	5-6
Chapter 6	Configuring Settings	6-1
6.1	Settings	6-2
6.2	General Settings 1/2	6-6
6.3	General Settings 2/2	6-21
6.4	Save Data Settings 1/2	6-46
6.5	Save Data Settings 2/2	6-62
6.6	Communication Settings	6-67
6.7	Voltage Quality Settings	6-72
6.8	Hardware Settings	6-76
6.9	Analog I/O Settings	6-88

Chapter 7	Measurements	7-1
7.1	Measurements	7-2
7.2	Measure Screens	7-3
7.3	Measuring Electric Energy	7-13
7.4	Measuring Demand	7-17
7.5	Displaying Zoom (Expanded View)	7-21
7.6	Measuring Harmonics	7-24
7.7	Displaying Waveform	7-34
7.8	Measuring Voltage Quality (Voltage Dip, Voltage Swell, or Instantaneous Interruption)	7-40
7.9	Checking Settings	7-43
7.10	Clearing Integrated Data	7-45
7.11	Measurement Data	7-46
Chapter 8	Saving Measured Data	8-1
8.1	Data Save	8-2
8.2	Saving Measured Data	8-6
8.3	Memory (Reference)	8-11
8.4	Backup Memory	8-13
8.5	Copying Screen Data (Hard copy)	8-15
Chapter 9	Processing File(s)	9-1
9.1	File Processing	9-2
9.2	Changing a File Name	9-4
9.3	Deleting a File	9-6
9.4	Formatting	9-9
9.5	Data Copy	9-10
9.6	Setting Files (Load/Save/Delete/Name Change)	9-14
9.7	Backup Memory Copy	9-24
9.8	Backup Memory Delete	9-25
Chapter 10	Using the Communication Function (RS-232)	10-1
10.1	Description of the Communication Function	10-2
10.2	Using a Personal Computer	10-4
10.3	Using a Printer	10-6

Chapter 11	PC Card	11-1
11.1	PC Card Specifications	11-2
11.2	Inserting and Removing the PC Card	11-3
11.3	Formatting the PC Card	11-4
11.4	Saving in the PC Card	11-5
Chapter 12	Using External Control Input/Output ...	12-1
12.1	External Control Input/Output	12-2
12.2	Connecting External Control Terminals.....	12-3
12.3	Using Multiple CW240 Units in Synchronization	12-4
Chapter 13	Using Analog Input/Output (Optional)	13-1
13.1	Analog Output (DA Output)	13-2
13.2	Analog Input	13-6
13.3	Connecting Analog Input/Output Terminals	13-8
Chapter 14	Power Failure Processing Function	14-1
Chapter 15	Other Functions	15-1
15.1	Holding the Display Value	15-2
15.2	Turning the LCD Backlight ON and OFF	15-3
15.3	Locking the Keys	15-4
15.4	Resetting the System	15-5
Chapter 16	Maintenance Troubleshooting	16-1
16.1	Things to Check When There is a Malfunction	16-2
16.2	Error Message Content and Actions	16-4
Chapter 17	CW 240 Specifications	17-1
17.1	CW 240 Specifications	17-2
17.2	Specifications of Current Clamps (Clamp-on Probe)	17-17

Appendix 1 Block Diagram App.1-1

Appendix 2 File/Print Item Descriptions App.2-1

**Appendix 3 Polarity (Active Power, Reactive Power,
Power Factor, Phase Angle) App.3-1**

**Appendix 4 Polarity
(Harmonic Measurement) App.4-1**

Appendix 5 Reactive Power Method App.5-1

Appendix 6 Sampling Method App.6-1

Appendix 7 Terminolo App.7-1

Introduction

Thank you for purchasing our CW240 Clamp-on Power Meter. This User's Manual describes the functions of the CW240 as well as its operating methods and handling precautions. Read this manual thoroughly before using the CW240, to ensure correct use.

In addition to this manual, the Quick Setup Manual and Communication Function Manual (CD-ROM) are available separately. The Quick Setup Manual briefly describes the basic procedures for performing such tasks as setup and measurement operations. Use the Quick Setup Manual together with this in-depth User's Manual. For more information on the communication functions, see the Communication Function Manual (CD-ROM).

After reading this manual, always keep it in an easily accessible convenient place for later reference. This manual will come in handy when you are unsure of how to operate the product.

Notices

The contents of this manual are subject to change without prior notice. In addition, figures and illustrations representing display views in this manual may differ from actual views.

Every effort has been made to ensure accuracy in the preparation of this manual. However, should any doubts arise or errors come to your attention, please contact one of the Yokogawa M&C sales offices listed on the back cover of this manual, or the sales representative from whom you purchased the product.

The contents of this manual may not be transcribed or reproduced, in part or in their entirety, without prior permission.

Trademark Acknowledgments

The company and product names referred to in this document are either trademarks or registered trademarks of their respective holders.

Revision Information

First Edition: June, 2004

Checking the Contents of the Package

After opening the package, be sure to check the product as instructed below before use. Should the product you have received be the wrong model, lack any items, or show any problems in its appearance, contact the vendor from whom you purchased the product.

Instrument Main Unit

Check the model name where MODEL is printed on the nameplate located at the back of the CW240 to ensure that the CW240 is exactly as specified in your purchase order.

Model and Suffix Codes

Model	Suffix Code	Specifications
CW240		
AC adapter	-D -F -R -S	Power cord: UL/CSA standard VDE standard SAA standard BS standard
Option codes	/DA /C1 /C2 /C3 /C4 /C5 /C6 /C7 /C8 /C9 /C10 /C11 /C12 /C13 /C14 /PM1	D/A output and analog input Clamp-on current probe for 96030, 2 pcs./set Clamp-on current probe for 96030, 4 pcs./set Clamp-on current probe for 96031, 2 pcs./set Clamp-on current probe for 96031, 4 pcs./set Clamp-on current probe for 96032, 2 pcs./set Clamp-on current probe for 96032, 4 pcs./set Clamp-on current probe for 96033, 2 pcs./set Clamp-on current probe for 96033, 4 pcs./set Clamp-on current probe for 96036, 2 pcs./set Clamp-on current probe for 96036, 4 pcs./set Clamp-on current probe for 96034, 2 pcs./set Clamp-on current probe for 96034, 4 pcs./set Clamp-on current probe for 96035, 2 pcs./set Clamp-on current probe for 96035, 4 pcs./set NiMH battery pack + carrying case

No. field: denotes the product number.

Refer to this number when inquiring about the product to the vendor.

Checking the Contents of the Package

Accessories

Make sure that the package contains all the accessories listed below and that they are all free from any damage.

Product Name	Part No.	Q'ty	Remarks
1. AC adapter for power supply	788011	1set	Yokogawa's AC adapter
2. AA-size alkaline batteries	-	6	
3. Voltage probes	91007	4	Color: black, red, yellow, blue
4. User's Manual	IM CW240	1	
5. Quick Setup Manual	IM CW240P	1	
6. CD-ROM		1	

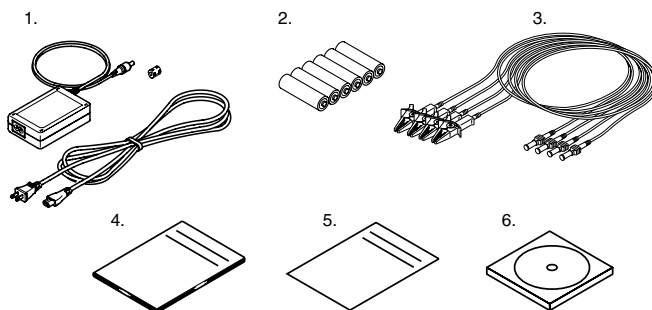

Checking the Contents of the Package

Peripherals (Optional)

The products listed below are available as optional peripherals. For technical and ordering inquiries concerning peripherals, contact the vendor from whom you purchased the product. If the product you purchased includes any one of the optional peripherals, make sure it is free from any damage.

Product Name	Part No.	Min.	Order Q'ty	Remarks
Clamp-on Probe				
for 200 A	96030	1		
for 500 A	96031	1		
for 700 A	96032	1		
for 50 A	96033	1		
for 3000 A	96034	1		Large-diameter type Selectable from 3000 A, 2000 A, and 1000 A
for 3000 A	96035	1		Flexible type Selectable from 3000 A and 300 A
for 2 A	96036	1		
Voltage probe	91007	1 set	4	
Carrying case	93020	1		
AC adapter	788011	1 set		Yokogawa's AC adapter
NiMH battery pack	94004			
AC adapter for 96035	A1020UP	1		For clamp-on Probes
Printer	97010	1		
AC adapter (for printer, Europe)	94006	1		
AC adapter (for printer, USA)	94007	1		
Thermal paper for printer	97080	10 rolls		
Memory card (with a PC card adapter)				
16 MB	97030	1		
32 MB	97031	1		
128 MB	97033	1		
256 MB	97034	1		
512 MB	97035	1		

TIP

It is advisable that the packing box be saved, as it is useful when you transport the product.

Housing the CW240 Main Unit and Accessories

An optional carrying case can accommodate the CW240 main unit with its clamp-on probes and voltage probes connected to the unit. The case can also house such accessories as the memory card, AC adapter, and User's Manual. As such, it comes in handy for transporting a complete kit of tools necessary for making measurements.

● **Example of Housing:**

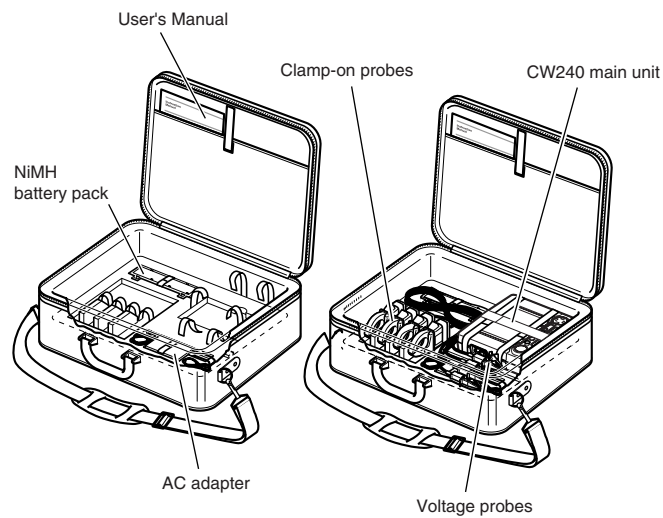

Precautions for Safe Use of the Instrument

When operating the instrument, be sure to observe the cautionary notes given below to ensure correct and safe use of the instrument. If you use the instrument in any way other than as instructed in this manual, the instrument's protective measures may be impaired. Yokogawa M&C Corporation is by no means liable for any damage resulting from use of the instrument in contradiction to these cautionary notes. The following safety symbols are used on the instrument and in this manual.



Danger! Handle with Care.

This symbol indicates that the operator must refer to an explanation in the User's Manual in order to avoid risk of injury or death of personnel or damage to the instrument.



Hazardous Voltage

The operator must never attempt to touch equipment or parts marked with this symbol.



Direct Current

This symbol indicates DC voltage/current.



Alternating Current

This symbol indicates AC voltage/current.



ON

This symbol indicates On (power).



OFF

This symbol indicates Off (power).



Double insulation

This symbol indicates double insulation.



WARNING

Indicates a hazard that may result in the loss of life or serious injury of the user unless the described instruction is abided by.



CAUTION

Indicates a hazard that may result in an injury to the user and/or physical damage to the product or other equipment unless the described instruction is abided by.

 **NOTE**

Indicates information that is essential for handling the instrument or, should be noted in order to familiarize yourself with the instrument's operating procedures and/or functions.

TIP

Indicates information that complements the present topic.

SEE ALSO

Indicates the reference location(s) for further information on the present topic.

Strictly observe the following cautionary notes in order to avoid the risk of injury or death of personnel or damage to the instrument due to hazards such as electrical shock.

 **WARNING**

-
- **Removal of the Case from the Instrument**
 - Do not remove the case from the instrument or disassemble/modify the instrument itself.
 - Some parts of the inside of the instrument contain high voltage and, therefore, access to the internal assembly is extremely hazardous. For inspection and/or adjustment of the internal assembly, contact the vendor from which you purchased the instrument.

 - **Use of the Instrument in a Gaseous Atmosphere**

Do not operate the instrument in a location where any flammable or explosive gas/vapor is present. It is extremely hazardous to operate it in such an atmosphere.

 - **Inspection of Power Source**
 - Before turning on the instrument, always make sure the voltage of the power source to be applied matches the instrument's supply voltage.
 - When using alkaline batteries or an NiMH battery pack, carefully read the cautionary notes on battery handling later in this manual.
-

 **WARNING**

- **Use of Clamp-on Current Probes**
 - When using clamp-on current probes, keep the circuit voltage below operating circuit voltage in order to avoid possible shorts or accidents resulting in an injury or death.
 - Ensure that the rated current of the circuit you measure matches the rating of the current probe.
 - Avoid using the instrument if it has been exposed to rain or moisture, or if your hands are wet.
 - Do not use clamp-on current probes with any non-insulated conductors.

 - **Handling of Power Cord**
 - Use only the cord supplied from Yokogawa M&C to prevent electric shocks and fire.
 - Do not place any load on the power cord or allow the power cord to come into accidental contact with any heat source. When unplugging the power cord from the outlet, hold its plug, rather than holding and pulling the cord itself.
 - If the power cord is damaged, contact the vendor from which you purchased the instrument.

 - **Measures in Case of Anomalies**

If the instrument begins to emit smoke, becomes too hot, or gives off an unusual smell, immediately turn it off and disconnect the power cord from the outlet. Also turn off power to the object under measurement that is connected to the instrument's input terminals. Never attempt to use the instrument again. If any such anomalies as noted above occurs, contact the vendor from which you purchased the instrument. Do not attempt to repair the instrument yourself, as doing so is extremely dangerous.
-

Utilisation en Toute Securite

Les précautions suivantes doivent être prises pendant l'exploitation, la maintenance et les réparations. YOKOGAWA M&C ne pourra en rien être déclaré responsable si ces précautions ne sont pas respectées par l'utilisateur.

- Symboles utilisés sur les appareils et dans les Manuels d'instruction.



Explication: ce symbole indique que l'opérateur doit se reporter à une explication donnée par le manuel d'instruction afin d'éviter un accident au personnel ou de protéger l'appareil.



Haute tension: Ne pas toucher!



Courant continu: Ce symbole indique une tension/intensité C.C.



Courant alternatif: Ce symbole indique une tension/intensité C.A.



MARCHE: Ce symbole indique la mise sous tension.



ARRET: Ce symbole indique la mise hors tension.



Double isolation: Ce symbole indique une double isolation.

AVERTISSEMENT

Indique un danger. Attire l'attention sur une utilisation, sur une procédure qui pourrait être dangereuse pour le personnel.

ATTENTION

Indique un danger. Attire l'attention sur une utilisation, sur une procédure qui pourrait être préjudiciable au produit.

AVERTISSEMENT

- **Retrait du boîtier de l'instrument**
 - Ne pas retirer le boîtier de l'instrument et ne pas essayer non plus de démonter/modifier l'instrument lui-même.
 - L'instrument renferme des composants parcourus par des tensions élevées. Il est donc extrêmement dangereux d'accéder à ses circuits internes. Pour vérifier et/ou régler les circuits internes, contacter le revendeur auprès duquel a été acheté l'instrument.

 - **Utilisation de l'instrument dans une atmosphère gazeuse**

Ne pas utiliser l'instrument dans un endroit qui renferme des gaz/vapeurs inflammables ou explosifs. Il est extrêmement dangereux d'utiliser l'instrument dans une telle atmosphère.

 - **Vérification de la source d'alimentation**
 - Avant de mettre l'instrument sous tension, toujours s'assurer que sa tension correspond à celle de la source d'alimentation.
 - En cas d'utilisation de piles alcalines ou d'un accumulateur NiMH, lire attentivement les mises en garde relatives à la manipulation des piles/accumulateurs, plus loin dans ce manuel.

 - **Utilisation des sondes d'intensité à pince**
 - Lors de l'utilisation des sondes d'intensité à pince, maintenir la tension du circuit au-dessous de operating circuit voltage afin d'écartier tout risque de court-circuit ou d'accident susceptible de provoquer des blessures qui peuvent éventuellement s'avérer mortelles.
 - Assurez-vous d'utiliser un capteur de courant dont le calibre correspond au niveau d'intensité à mesurer.
 - Éviter d'utiliser l'instrument si celui-ci a été exposé à la pluie ou à l'humidité, ou encore si vos mains sont humides.
 - Ne pas utiliser les sondes d'intensité à pince avec des conducteurs non isolés.
-
-

 **AVERTISSEMENT**

- **Manipulation du cordon d'alimentation**
 - Afin de prévenir tout feu ou choc électrique, n'utilisez que le cordon fourni par Yokogawa M&C.
 - Ne déposer aucune charge sur le cordon d'alimentation et éviter tout contact fortuit entre celui-ci et une source de chaleur. Pour débrancher le cordon de la prise secteur, tirer sur sa fiche, mais jamais sur le fil proprement dit. Si le cordon d'alimentation est endommagé, contacter le revendeur auprès duquel a été acheté l'instrument.

 - **Mesures à prendre en cas d'anomalies**

Si l'instrument est brûlant, dégage de la fumée ou une odeur inhabituelle, le mettre immédiatement hors tension et débrancher le cordon d'alimentation de la prise secteur. Mettre également hors tension le circuit sur lequel est effectuée la mesure et qui est raccordé aux bornes d'entrée de l'instrument. Ne surtout pas essayer d'utiliser l'instrument à nouveau. Si l'une de ces anomalies est détectée, contacter le revendeur auprès duquel a été acheté l'instrument. Ne pas essayer de le réparer soi-même, car cela est extrêmement dangereux.
-
-

Chapter 1 Product Overview

1.1	Product Overview	1-2
1.2	System Configuration Diagram	1-4

- **Wide measurement range**

Voltage range: 150 V, 300 V, 600 V, and 1000 V

Current range: compatible with 7 types of clamp-on current probes
From 200 mA to 3000 A maximum

- **Power quality analysis measurement**

Power quality analysis can be made using harmonics (1st to 50th order), voltage dip/swell/momentary interruption, and waveform measurement functions.

- **Wiring check and setup check**

- The wiring check function allows you to check a voltage phase sequence or reverse connection of clamp-on current probes.
- The setup check function allows you to check settings for integration measurements.

- **Data management and communication**

- Data can be saved using a personal computer (PC) card.
- Data can be transferred to a PC and setup can be made from the PC through communications.

- **Equipped with 4CH DA outputs and 2CH analog inputs (DC V) (optional)**

- Measured values can be converted into DC voltage and then analog-output to a recorder or other devices.
- Analog outputs from a thermometer or illuminometer can be connected to the analog input terminals of the CW240 to measure power data and environmental data together.

1.2 System Configuration Diagram

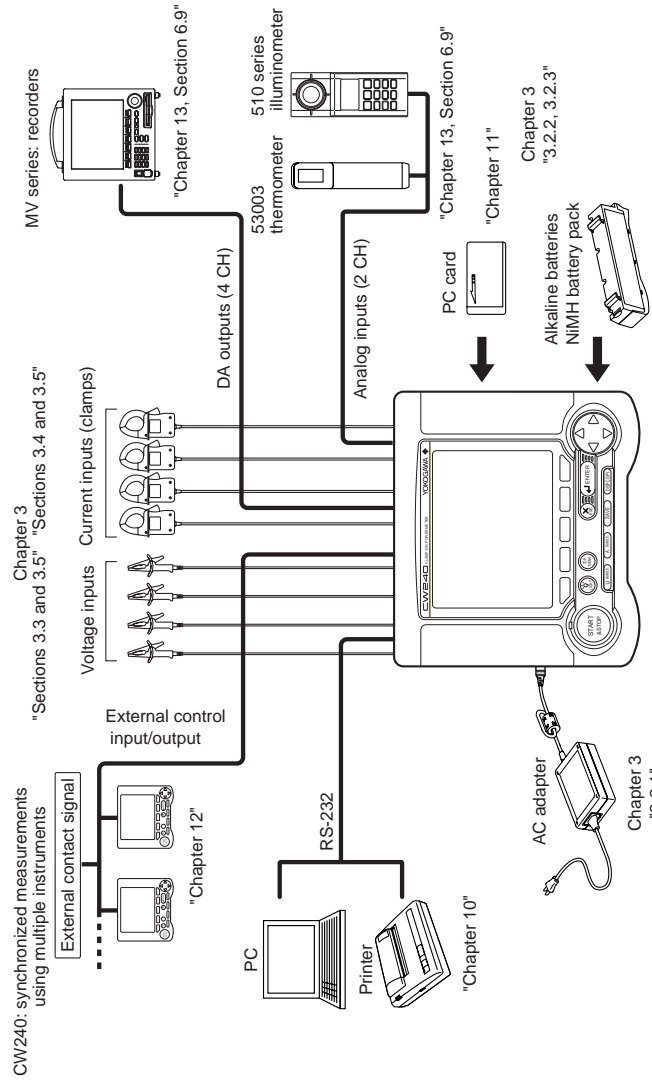

Chapter 2 Part Names and How to Use Parts

2.1	Front Panel and Connector Block	2-2
2.2	Operation Keys	2-3
2.3	Side Faces	2-4
2.4	Screen Configuration	2-5
2.5	Overrange/Error Indication during Measurement	2-6
2.6	Description of Mark Indication	2-11

2.1 Front Panel and Connector Block

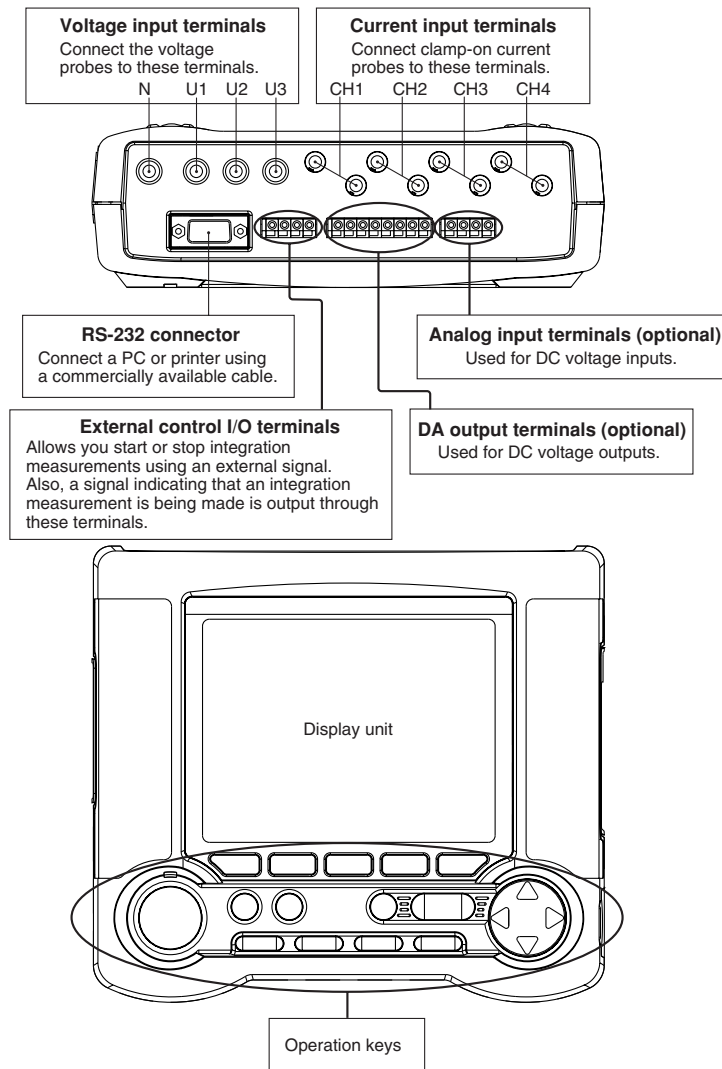

2.2 Operation Keys

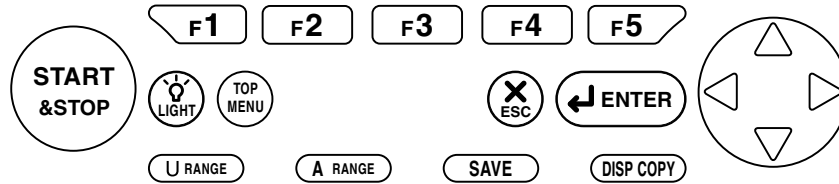

Key Name	Functional Description
Function keys F1 to F5	These are setting keys corresponding to the information displayed in the bottom of the screen.
START & STOP key	Starts/stops integration measurements.
LIGHT key	Turns the backlight ON/OFF. When held down for more than 3 seconds, it locks or unlocks the operation keys.
TOP MENU key	Switches the display screen to the Top Menu.
ESC key	Cancels setup conditions or other data.
ENTER key	Confirms setup conditions or other data.
Cursor key 	Moves the cursor to the item you wish to select.
U RANGE key	Changes the voltage range.
A RANGE key	Changes the current range.
SAVE key	Manually save or print measured data.
DISP COPY key	Hard-copies information displayed on the screen. Copy destination setting: PC card, internal memory, or printer

2.3 Side Faces

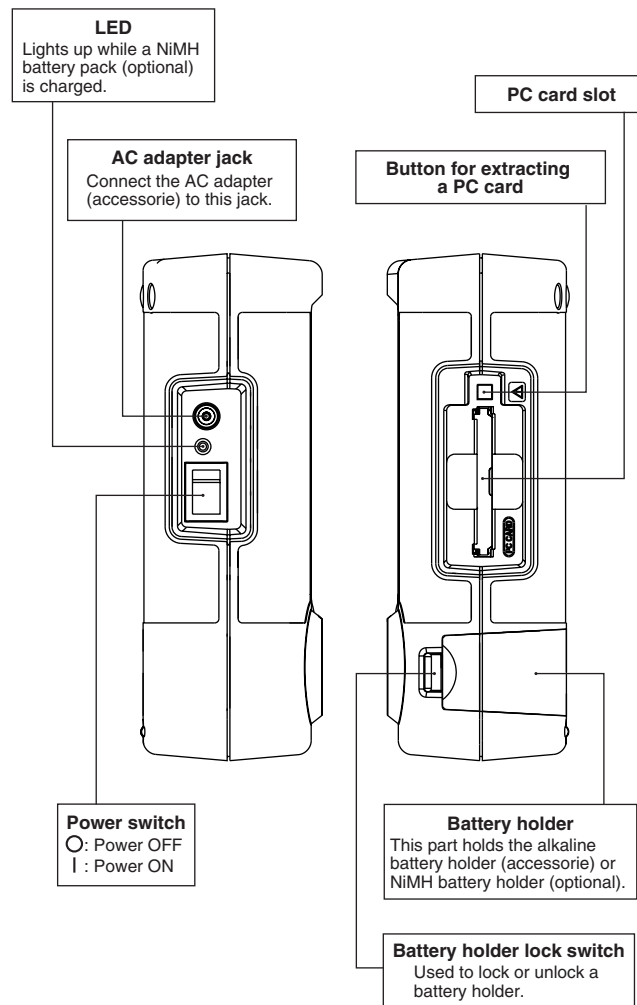

2.4 Screen Configuration

● Basic Screen Configuration

2

Part Names and How to Use Parts

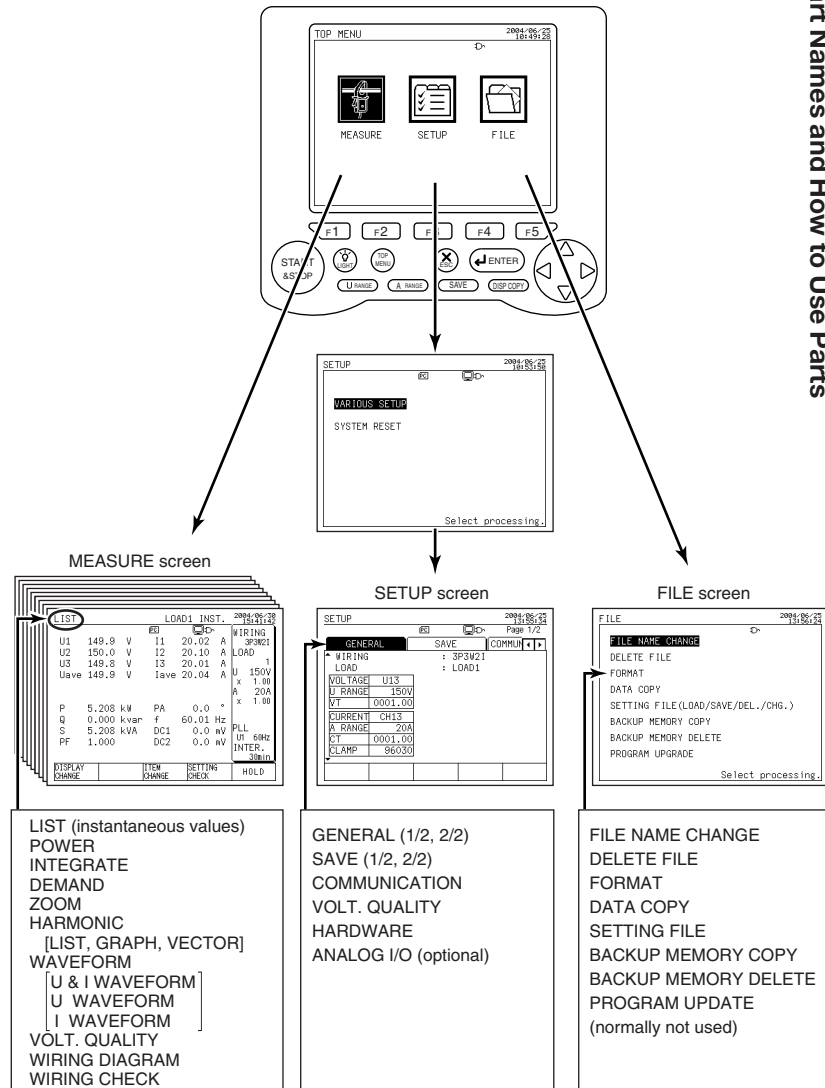

2.5 Overrange/Error Indication during Measurement

● Overrange Indication during Measurement



Conditions for voltage overrange indication

This mark appears if the peak value of an input signal exceeds 300% (180% for a 1000 V range) of the rated voltage range or if the rms value of measured voltage exceeds 110% of the rated range.

Conditions for current overrange indication

This mark appears if the peak value of an input signal exceeds 400% of the rated current range or if the rms value of measured current exceeds 110% of the rated range.

TIP

- Voltage overrange mark  appears if an input signal to one of terminals U1 to U3 satisfied the noted conditions.
 - Current overrange mark  appears if an input signal to one of terminals CH1 to CH4 satisfies the noted conditions.
-

Indication of "OR" or "----" symbol

The CW240 indicates "OR" or "----" symbol instead of a usual four-digit value if the measured value meets the noted conditions.

WARNING

The CW240 shows an overrange mark in the maximum range only if the input level exceeds the maximum allowable level. Do not apply any input level higher than the maximum allowable level.

CAUTION

To measure an input signal level exceeding the rated range, use a voltage transformer (VT) or current transformer (CT).

When using a VT or CT, carefully read section 4.5, Wiring the Measurement Circuit Using External VT/CT.

2.5 Overrange/Error Indication during Measurement

• Instantaneous value, electric energy, demand

Measurement Item	Conditions and Indications
Voltage rms	If the peak value of an input signal exceeds 300% (180% for the 1000 V range) of the measurement range, or if the rms value of measured voltage exceeds 130% of the rated range, "OR" appears.
Current rms	If the peak value of an input signal exceeds 400% of the measurement range, or if the rms value of measured current exceeds 130% of the rated range, "OR" appears.
Active power Reactive power Apparent power	If power input (active, reactive, or apparent) exceeds 130% of the rated range, "OR" appears. Also, if the measured value exceeds the maximum displayable digits, 9999, "OR" appears.
Power factor Phase angle	If the peak value of a voltage input signal exceeds 300% (180% for a 1000 V range) of the measurement range; if the rms value of measured voltage exceeds 130% of the rated range; if the peak value of a current input signal exceeds 400% of the measurement range; or if the rms value of measured current exceeds 130% of the rated range; "----" appears.
Frequency	If frequency exceeds 70 Hz, the fixed clock is selected.
Interval electric energy Electric energy Reactive energy	Even if power input exceeds 130% of the rated range, an excessive power value (active power, reactive power) will be integrated. In this case, however, the accuracy of an integrated value is not specified.
Power demand Reactive power demand	If a demand input exceeds 130% of the rated range, "OR" appears. Also, if the measured value exceeds the maximum displayable digits, 9999, "OR" appears.
Analog input (optional)	If an input exceeds 130% of the rated range, "OR" appears.

2.5 Overrange/Error Indication during Measurement

• Harmonics

Measurement Item	Conditions and Indications
Voltage rms	If the peak value of an input signal exceeds 300% (180% for a 1000 V range) of the measurement range, or if the rms value of measured voltage exceeds 130% of the rated range, "OR" appears.
Voltage content Voltage phase angle	If the peak value of an input signal exceeds 300% (180% for the 1000 V range) of the measurement range, or if the rms value of measured voltage exceeds 130% of the rated range, "----" appears.
Current rms	If the peak value of an input signal exceeds 400% of the measurement range or if the rms value of measured current exceeds 130% of the rated range, "OR" appears.
Current content Current phase angle	If the peak value of an input signal exceeds 400% of the measurement range, or if the rms value of measured current exceeds 130% of the rated range, "----" appears.
Power value	If a power input exceeds 130% of the rated range, "OR" appears. Also, if the measured value exceeds the maximum displayable digits, 9999, "OR" appears.
Power content Power phase angle	If the peak value of a voltage input signal exceeds 300% (180% for a 1000 V range) of the measurement range; if the rms value of measured voltage exceeds 130% of the rated range; if the peak value of a current input signal exceeds 400% of the measurement range; or if the rms value of measured current exceeds 130% of the rated range; "----" appears. Also, if the power value exceeds the maximum displayable digits, 9999, "----" appears.
Total harmonic distortion of voltage	If the peak value of a voltage input signal exceeds 300% (180% for a 1000 V range) of the measurement range, or if the rms value of measured voltage exceeds 130% of the rated range, "----" appears.
Total harmonic distortion of current	If the peak value of a current input signal exceeds 400% of the measurement range or if the rms value of measured current exceeds 130% of the rated range, "----" appears.

2.5 Overrange/Error Indication during Measurement

- Indication Provided if a Measured Value is Too Small
- Instantaneous value, electric energy, demand

Measurement Item	Conditions and Indications
Voltage	If an input level is below 0.4% of the rated range, the reading becomes "0 V".
Current	If an input level is below 0.4% of the rated range, the reading becomes "0 A".
Active power	If an input level is 0.17% or less of the rated range, the reading becomes "0 W".
Reactive power	If an input level is 0.17% or less of the rated range, the reading becomes "0 Var".
Apparent power	If an input level is 0.17% or less of the rated range, the reading becomes "0 VA".
Electric energy	If power input is 0.17% or less of the rated range, integration stops.
Reactive energy	If reactive power input is 0.17% or less of the rated range, integration stops.
Power factor Phase angle	If the input level of either voltage or current is below 0.4% of the rated range, "----" appears.
Frequency	If frequency is 40 Hz or less or if the input level of a frequency source is 10% or less of the rated range, the fixed clock is selected, displaying the set fixed-clock frequency.
Interval electric energy	If power input is 0.17% or less of the rated range, integration stops.
Power demand	If power demand is 0.17% or less of the rated range, the reading becomes "0 W".
Reactive power demand	If reactive power demand is 0.17% or less of the rated range, the reading becomes "0 Var".
Analog input (optional)	If an input level is below 0.4% of the rated range, the reading becomes "0 V".

2.5 Overrange/Error Indication during Measurement

● Indications on the basis of other input conditions















Measurement Item	Conditions and Indications
Electric energy Reactive energy	<ul style="list-style-type: none"> When the display setting is any item other than AUTO, if the integrated value exceeds "999999", the reading is reset to "0", letting integration continue. When the display setting is AUTO, the position of a decimal point or the unit of measurement is shifted by one digit to continue integration.
Power factor	Because of a computation error, if the power factor: <ul style="list-style-type: none"> Exceeds 1.0, the reading becomes "1.0." Is less than -1.0, the reading becomes "-1.0." Is $S < P$, the reading becomes "1.0."
Power factor demand Total power factor	Because of a computation error, if the power factor: <ul style="list-style-type: none"> Exceeds 1.0, the reading becomes "1.0." Is less than -1.0, the reading becomes "-1.0."
Phase angle	If the power factor exceeds 1.0 or is less than -1.0 due to a computation error, the reading becomes "0°."
Power phase angle	If the total power factor exceeds 1.0 or is less than -1.0 due to a computation error, the reading becomes "0°."
Reactive power	Because of a computation error, if <ul style="list-style-type: none"> A value in $\sqrt{\quad}$ is negative, the reading becomes "0." $S < P$, the reading becomes "0."
Apparent power	If $S < P $ due to a computation error, $S = P $.

Legend

P : active power value

S : apparent power value

2.6 Description of Mark Indication

	Appears if a voltage overrange occurs.
	Appears if a current overrange occurs.
	Appears when integration measurement is made by external input control.
	Appears in the event of loss of PLL synchronization. This automatically selects the fixed clock.
	Appears when a reactive power meter method is used.
	Appears when display hold is enabled.
	Appears if the amount of data exceeds the capacity of a PC card or the internal memory.
	Appears when the CW240 is configured so that data is saved in a PC card. Also, this mark flashes during an access to the PC card.
	Appears when data has been saved in the backup memory.
	Appears when the CW240 is configured so that data is saved in the internal memory. Also, this mark flashes during an access to the internal memory.
	Appears if the CW240 is in a key lock state.
	Appears when the CW240 is configured so that the RS-232 connection destination is a PC. Also, this mark flashes during communication with the PC.
	Appears if the CW240 is configured so that the RS-232 connection destination is a printer. Also, this mark flashes during communication with the printer.
	Appears if the CW240 is powered through the AC adapter.
	Appears when the CW240 is powered through alkaline batteries or a NiMH battery pack. This mark indicates a battery voltage decrease (remaining capacity) in four steps.

Chapter 3 Preparation for Safe Measurements

3.1	Precautions for Use	3-2
3.2	Connecting a Power Supply	3-4
3.3	Connecting Voltage Probes	3-14
3.4	Connecting Clamp-on Probes	3-15
3.5	Connection Diagrams of Voltage Probes and Clamp-on Probes	3-17
3.6	Turning ON the Power Switch	3-22
3.7	Performing Measurements with Greater Precision	3-24

3.1 Precautions for Use

If you are a first-time user, always read the "Precautions for Safe Use of the CW240" on pages 6 through 11.

- **Do not place any objects on the instrument.**

Do not place another device or a container filled with water on the instrument, otherwise, the instrument may become defective.

- **Moving the Instrument**

Before moving the instrument, check that the power cord and all other cables are disconnected. Hold the instrument with both hands when moving it.

- **Input terminals**

Do not bring a charged substance close to the signal terminals, otherwise the internal circuitry may be destroyed. Do not apply any mechanical shock to the signal terminals because it might be transformed into an electrical noise and input into the instrument.

- **Protection of the case or operation panel**

Do not pour volatile chemicals on the case or operation panel or leave any rubber or PVC product in contact with the case or operation panel for a prolonged period, otherwise the case and/or operation panel may be discolored or deformed.

- **Cleaning**

When cleaning the case and/or operation panel, disconnect the power cord from the outlet and gently wipe the external surfaces with a soft clean cloth. Do not use chemicals such as benzine or thinner, otherwise the instrument may be discolored or deformed.

- **Display screen**

When the instrument is shipped from the factory, the LCD display screen is covered with a protective film. Remove it before using the instrument.

- **After use**

Disconnect the power cord from the wall outlet after use.

- **Long absence of use**

If the instrument will not be used for a prolonged period, remove the batteries (AA-size alkaline batteries or NiMH battery pack).

Precautions for Using Clamp-on Probes

 **CAUTION**

-
- The clamping CT (current transformer) is precision assembled to ensure high performance. When using a clamp, do not apply any intense mechanical shock, vibration, or force to the clamping CT.
 - If dust or any other foreign matter gets in the clamping CT, do not shut the clamping cores tight. First remove dust and then make sure the clamping cores on both sides close smoothly
-

3.2 Connecting a Power Supply

To connect the instrument to a power supply, use the AC adapter(accessorie).

As backup power supply against a power failure, one of the following batteries can be used. Use them together with the AC adapter.

- Alkaline batteries (accessorie)
See 3.2.2, Using Alkaline Batteries.
- NiMH battery pack (optional)
See 3.2.3, Using a NiMH (Nickel-Hydrogen) Battery Pack.

3.2.1 Connecting the AC Adapter

● Before Connecting a Power Supply

There is a danger of electrical shock or damage to the instrument. Observe the following cautionary notes when handling the AC adapter.

WARNING

-
-
- Use only the Yokogawa-supplied dedicated power cord.
 - Check that the power source voltage matches the supply voltage rating of the AC adapter, and then connect the power cord to the outlet.
 - Check that the power switch of the CW240 is turned OFF and then connect the power cord.
 - If the CW240 is not used for a prolonged period, disconnect the AC adapter power cord from the outlet.
 - Do not use any AC adapter other than the one (part number: 788011) dedicated to the CW240.
 - Do not place any objects on the AC adapter or power cord, and do not let the power cord come into contact with a heating element.
 - Always hold the plug of the power cord rather than holding and pulling the cord itself when disconnecting it from the outlet.
-
-

3.2 Connecting a Power Supply

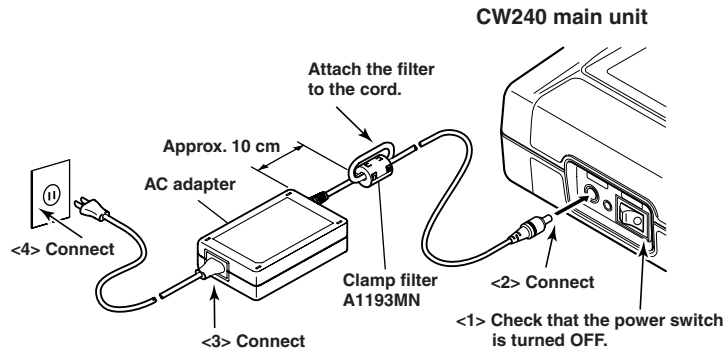

● Procedure for Connecting the AC Adapter

Follow the steps below to connect the AC adapter.

<1> Check that the power switch of the CW240 is turned OFF.

(Attach the clamp filter to the output-side cable of the AC adapter.)

<2> Connect the AC adapter plug to the CW240's AC adapter jack.

<3> Connect the plug of the power cord supplied with the AC adapter to the power connector of the AC adapter.

<4> Connect the other end of the power cord to the power outlet that meets the power rating (requirements):

● AC adapter's Power Rating

Supply voltage rating	100 to 240 V AC
Allowable supply voltage range	90 to 264 V AC
Power supply frequency rating	50/60 Hz
Allowable power supply frequency range	48 to 62 Hz
Maximum power consumption	70 to 90 VA
Output voltage rating of AC adapter	12 V DC
Maximum output current rating of AC adapter	2.6 A

3.2 Connecting a Power Supply

3.2.2 Using Alkaline Batteries

NOTE

Alkaline batteries are the backup power for the AC adapter. Use them together with the AC adapter.

Type of alkaline batteries LR6 AA-type, 1.5 V

● Handling Precautions

Observe the following cautionary notes when handling alkaline batteries.

WARNING

- Install the alkaline batteries so that the positive and negative polarities are correctly positioned. Otherwise, the battery fluid may leak or the batteries may explode.
 - Do not attempt to disassemble the batteries, heat them up, or dispose of them in a fire.
 - Do not short the batteries.
 - Do not attempt to recharge the batteries.
 - Do not solder the batteries.
 - When replacing the batteries, replace all six units at the same time with new ones (of the same manufacturer).
(Do not use manganese batteries as replacements.)
 - If the CW240 will not be used for a prolonged period, remove the batteries.
-

● Backup Hours by Alkaline Batteries

The number of backup hours available using alkaline batteries varies with the operating environment and conditions. Refer to the table below.

Operating Conditions	Backup Hours Available
LCD backlight OFF No access to a PC card	Approx. 30 minutes

3.2 Connecting a Power Supply

● Indication of a Battery Voltage Decrease

When the CW240 is operated using alkaline batteries, the following mark appears. A decrease in the battery voltage (remaining capacity) is indicated in the following four steps:

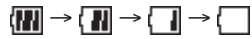

NOTE



If you continue to operate the CW240 with this mark displayed, the CW240 will be turned OFF automatically. Replace the alkaline batteries with new ones before this mark appears.

3.2 Connecting a Power Supply

● Procedure for Replacing Alkaline Batteries

Follow the steps below to replace alkaline batteries.

- <1> Check that the power switch is OFF and no AC adapter has been connected.
- <2> Raise the battery holder lock switch at the back of the CW240 to remove the alkaline battery holder.
- <3> Remove the old batteries from the battery holder and insert six new alkaline batteries.
- <4> Place the battery holder into the holder inlet of the CW240. Then slide the battery holder into the slot, so that the battery holder connector connects properly with the battery connector.
- <5> Lower the lock switch on the side of the CW240 to fix the holder.
(The indication changes to "△FREE".)

CAUTION

Place alkaline batteries into the holder with the positive (+) and negative (-) polarities of the batteries agreeing with the polarity indications in the holder.

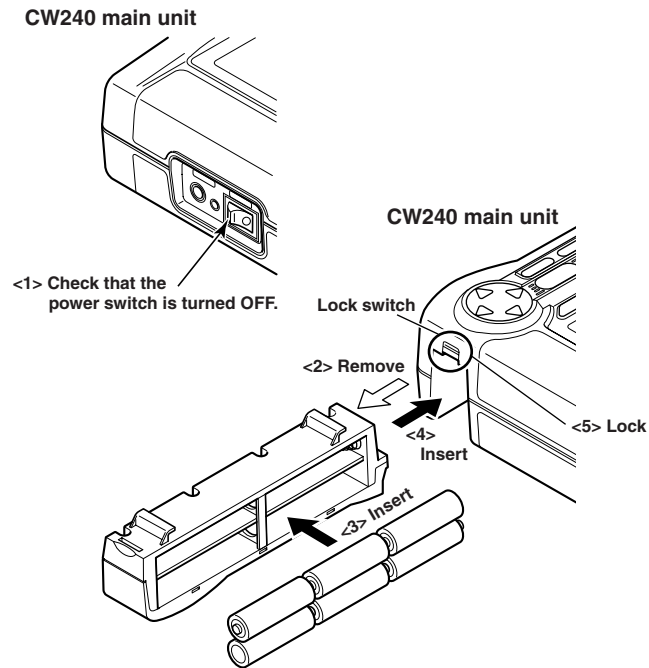

3.2.3 Using a NiMH (Nickel-Hydrogen) Battery Pack

NOTE

A NiMH battery pack is backup power for the AC adapter. Use it together with the AC adapter.

Charging type	NiMH battery pack (optional)	model: 94004
Specifications	Voltage : 7.2 V Capacity : 2100 mAh Number of times chargeable (cycle life) : approx. 300 times (depending on the operating environment)	

● Handling Precautions

Observe the following cautionary notes when handling the NiMH battery pack.

WARNING

- The electrolyte solution contained in the NiMH battery pack is alkaline. If it comes into contact with any clothing or skin due to a leakage from or rupture in the battery pack, the clothing or skin may be damaged. In particular, if the solution gets into an eye, it may cause loss of eyesight. In such a case, do not rub the affected eye, but thoroughly wash it immediately with clean water. Then see a doctor quickly for treatment.
- When replacing the NiMH battery pack, always turn the CW240 power switch OFF and disconnect the AC adapter power cord from the outlet to avoid possible danger such as a short in the electric circuit or electrical shock.
- Do not use any battery pack other than Yokogawa's NiMH battery pack (model: 940 04).
- Do not leave the NiMH battery pack in strong direct sunlight, inside a vehicle under the hot sun, or near a fire, otherwise it may result in a solution leakage or deterioration in the performance and/or life.
- Do not disassemble or modify the NiMH battery pack, otherwise the protective features of the battery pack may be damaged, resulting in a heating up or rupture.
- Do not short the NiMH battery as this may cause burns due to the battery pack heating up.
- Do not dispose of the battery pack in a fire or apply heat to it, otherwise there is a risk that it will rupture or its electrolyte solution will scatter.
- Do not apply excessive shock to the battery pack, for example, by throwing it. Doing so may cause solution leakage, battery pack heating, or rupture.

3.2 Connecting a Power Supply

WARNING

- Do not use a defective battery pack, such as any leaking solution, deformed, discolored, or showing any other abnormality.
- Avoid any metal coming into contact with the battery pack when carrying it, as there is a danger of a short.
- Do not immerse the battery pack in water or make it wet. Otherwise, it may heat up or rust as well as leading to a loss of functions.
- If the battery pack is not used for a prolonged period, remove it from the CW240 and store it in the following environment.

Storage period of 1 year or less:

Temperature of -20°C to 35°C (in locations with low humidity)

Storage period of 3 months or less:

Temperature of -20°C to 45°C (in locations with low humidity)

● Procedure for Installing the NiMH Battery Pack

Follow the steps below to install the dedicated NiMH battery pack.

<1> Check that the power switch is turned OFF.

<2> If the AC adapter is in use, disconnect the power cord of the AC adapter from the outlet.

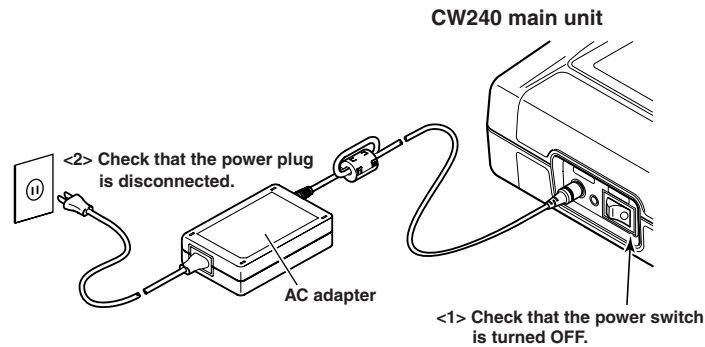

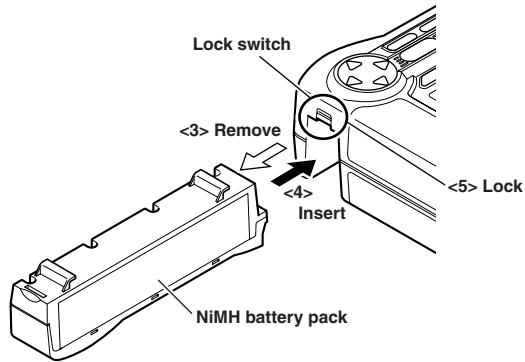

- <3> If using alkaline batteries, raise the lock switch at the back of the CW240 to remove them from the battery holder. Then install the NiMH battery pack into the holder.
- <4> Place the battery holder into the holder inlet of the CW240. Slide the battery holder into the slot, so that the battery holder connector connects properly with the battery connector.
- <5> Lower the lock switch on the side of the CW240 to fix the holder.
(The indication changes to "△FREE".)

● Recharging the NiMH Battery Pack

When shipped from the factory, the dedicated NiMH battery pack (optional) is not fully charged for safety reasons.

Recharge the battery pack to its full level before use.

When recharging it, use the CW240 and AC adapter.

WARNING

- When recharging the NiMH battery pack, always do so using the CW240 main unit.
- When recharging the NiMH battery pack, keep the ambient temperature within the range from 10°C to 35°C. Recharging the battery pack outside this range may result in an insufficient amount of charge, solution leakage, or battery heating.

3.2 Connecting a Power Supply

● Procedure for Recharging the NiMH Battery Pack

Follow the steps below to recharge the NiMH battery pack.

- <1> With the battery pack installed as instructed above, connect the AC adapter to the CW240.
- <2> The LED indicator on the side of the AC adapter jack comes on, indicating that the battery pack is being recharged. When recharging is complete, the LED indicator goes off.

NOTE

The NiMH battery pack will be recharged regardless of the ON/OFF of the power switch. In this case, power is supplied through the AC adapter.

TIP

When the LED indicator is flashing, the CW240 is in a waiting-to-be-recharged state. The CW240 falls into this state if:

- the ambient temperature is outside the 10°C to 35°C range,
 - the battery performance is significantly low due to over-discharge or for other reasons,
 - the battery temperature has exceeded 55°C during recharging, or
 - the ambient temperature has changed abruptly.
-

● Indication that Recharging is Required

When the CW240 is operated using the NiMH battery pack, the following mark appears. A decrease in the battery voltage (remaining capacity) is indicated in the following four steps:

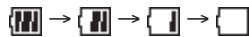

NOTE



If you continue to operate the CW240 with this mark displayed, the CW240 will be turned OFF automatically. Recharge the NiMH battery pack before this mark appears.

3.2 Connecting a Power Supply

● Backup Hours with a NiMH Battery Pack

The number of backup hours available using a NiMH battery pack vary with the operating environment and conditions. Refer to the table below.

Operating Conditions	Backup Hours Available
LCD backlight OFF No access to a PC card	Approx. 3 hours

● NiMH Battery Life

The NiMH battery pack can be recharged approximately 300 times, though the frequency depends on the operating environment. The life of the battery pack is over if the low-battery mark appears soon after the battery pack has been fully recharged. Replace the battery pack with a new one.

3.3 Connecting Voltage Probes

WARNING

- For safety, connect voltage probes to the CW240 main unit and then to the circuit under test.
- Before attaching a voltage probe to the circuit under test, turn off power to the circuit under test. It is very dangerous to connect or disconnect a voltage probe without turning off the circuit under test.
- Be sure to connect voltage probes to the secondary side of the circuit under test such as current limiters (circuit breakers). Should an accident such as a short occur, other circuits will be protected by these circuit breakers.
- Be extremely careful not to connect a voltage circuit to the current input terminals or a clamp-on probe to the voltage input terminals. An improper connection may result in not only damage to the circuit or equipment under test or the CW240, but also an injury to personnel.
- Voltage input terminals N, U1, U2, and U3 are not isolated from each other. Do not connect any voltage probes not required (not used) for measurements. Also, do not touch voltage input terminals not used.
- For measurements, do not use any voltage probes other than those supplied with the product.

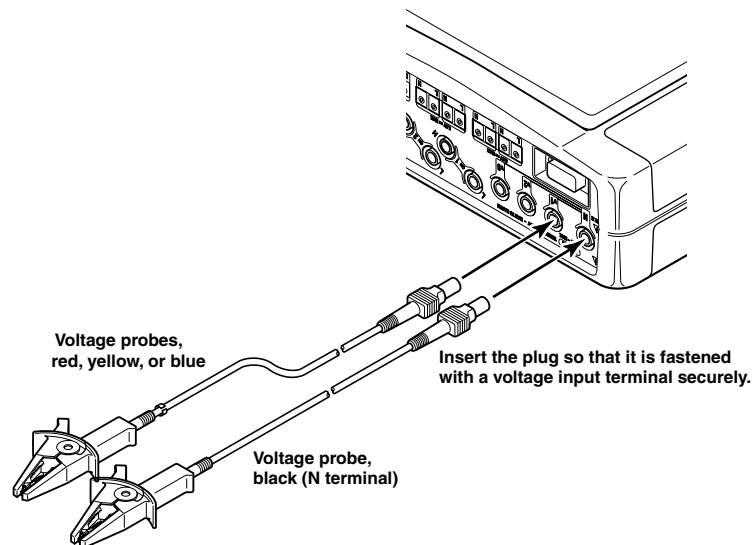

3.4 Connecting Clamp-on Probes

WARNING

- For safety, connect a clamp-on probe to the CW240 main unit and then to the circuit under test.
- Before clamping a clamp-on current probe onto the circuit under test, turn off power to the circuit under test. It is very dangerous to clamp or unclamp the clamp-on probe without turning off the circuit under test.
- Be sure to connect a clamp-on probe to the secondary side of the circuit under test such as current limiters (circuit breakers). Should an accident such as a short occur, other circuits will be protected by these circuit breakers.
- Be extremely careful not to connect a voltage circuit to the current input terminals or a clamp-on probe to the voltage input terminals. An improper connection may result in not only damage to the circuit or equipment under test or the CW240, but also an injury to personnel.
- Do not connect any clamp-on probe not required (not used) for measurement.
- For measurements, do not use any current probes other than those dedicated to the CW240.
- Do not use a clamp-on probe for a non-insulated conductor.

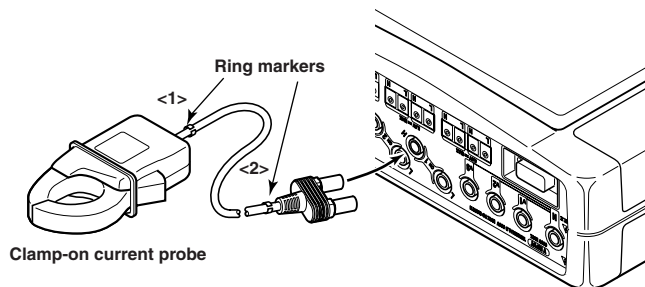

● Use of Ring Markers

- When using multiple clamp-on probes, attach ring markers (four colors) to the probes. This allows inputs to be identified. Attach ring markers of the same color to the current probe side <1> and connector side <2> of the cable of a clamp-on probe.
- When attaching ring markers, exercise care not to damage the clamp-on probes.

3.4 Connecting Clamp-on Probes

● Connecting Clamp-on Probes

When connecting a clamp-on probe to the CW240 main unit, connect the plug of the clamp-on probe so that the groove in the plug agrees with the guide in the CW240 main unit (that the H and L polarities are correctly connected).

● Types of Clamp-on Probes

Clamp-on probes that can be connected to the CW240 are available in the following seven types. The CW240's current range setting changes depending on the clamp-on probes in use.

Model	CW240 Current Range
96036 (for 2 A)	200 mA/500 mA/1 A/2 A
96033 (for 50 A)	5 A/10 A/20 A/50 A
96030 (for 200 A)	20 A/50 A/100 A/200 A
96031 (for 500 A)	50 A/100 A/200 A/500 A
96032 (for 700 A) 1000 A (for 5 minutes)	200 A/500 A/1000 A
96034 (for 3000 A)	Current range is selectable using a switch.
96034_1	300 A/750 A/1500 A/3000 A
96034_2	200 A/500 A/1000 A/2000 A
96034_3	100 A/200 A/500 A/1000 A
96035 (for 3000 A)	Current range is selectable using a switch.
96035_1	300 A/750 A/1500 A/3000 A
96035_2	30 A/75 A/150 A/300 A

CAUTION

When connecting a clamp-on probe, always check that the rating of the current under test agrees with the rating of the clamp-on probe, including model number check.

3.5 Connection Diagrams of Voltage Probes and Clamp-on Probes

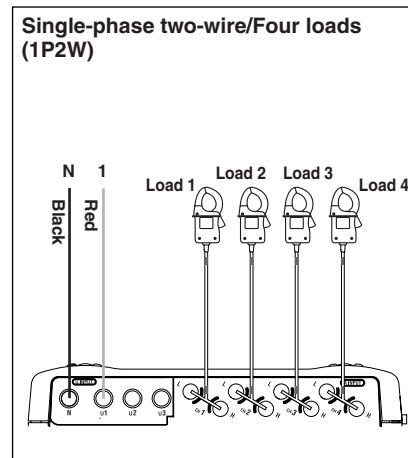
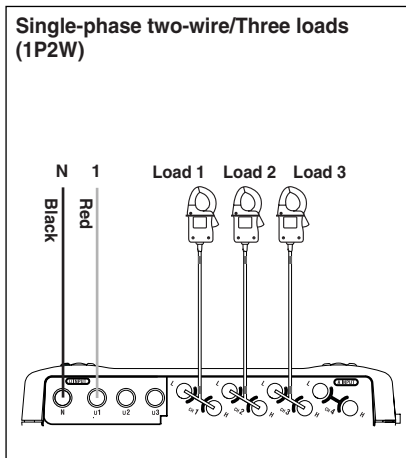
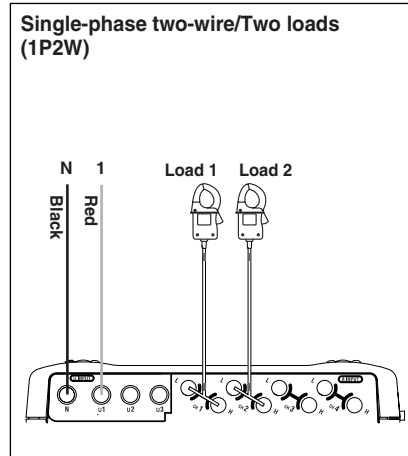
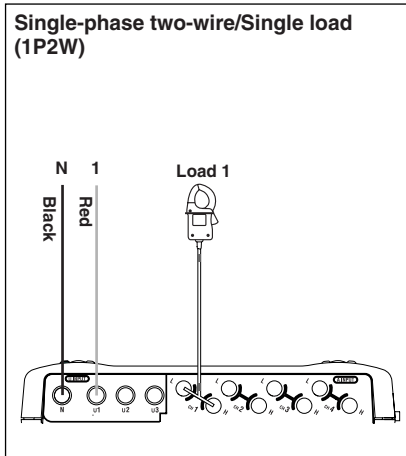

3.5 Connection Diagrams of Voltage Probes and Clamp-on Probes

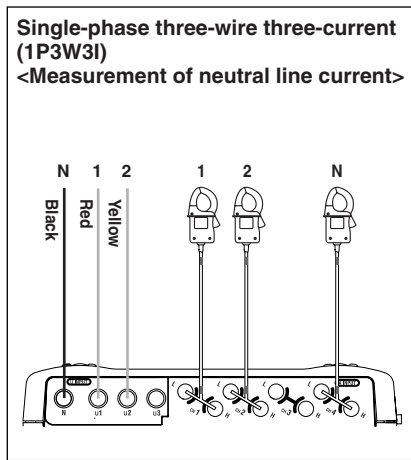
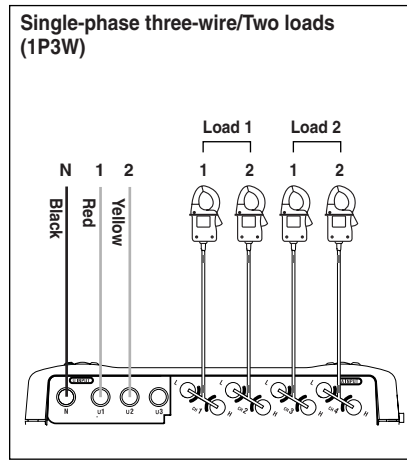
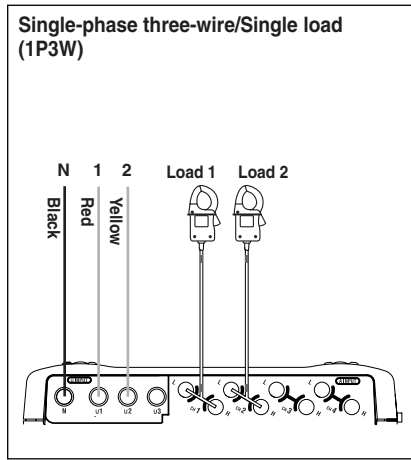

3.5 Connection Diagrams of Voltage Probes and Clamp-on Probes

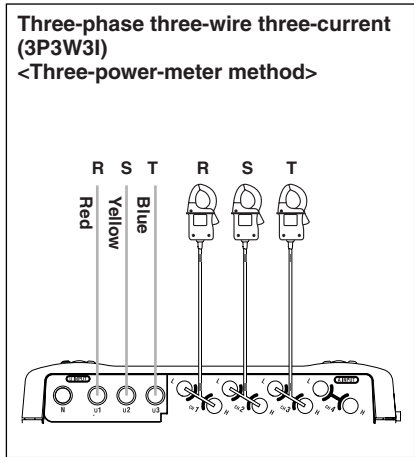
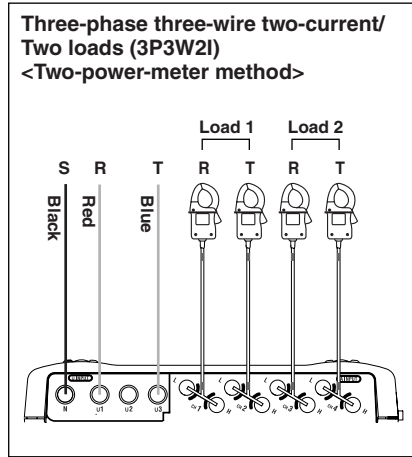
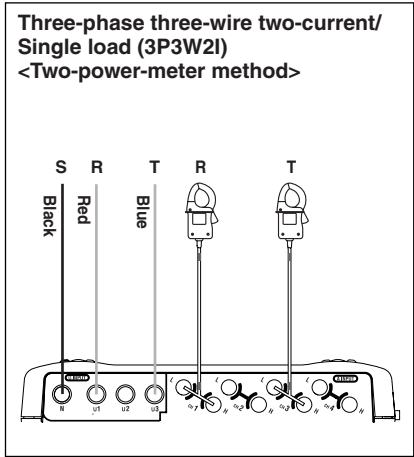

3.5 Connection Diagrams of Voltage Probes and Clamp-on Probes

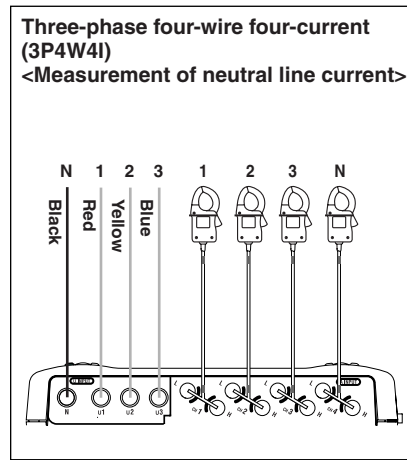
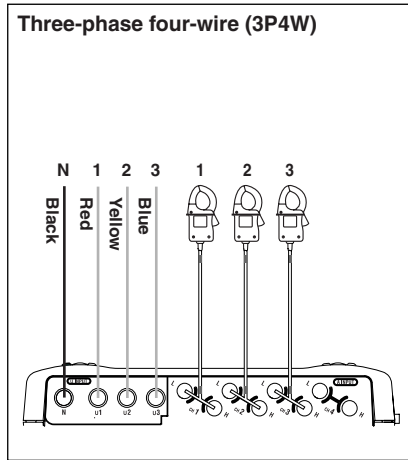

3.5 Connection Diagrams of Voltage Probes and Clamp-on Probes

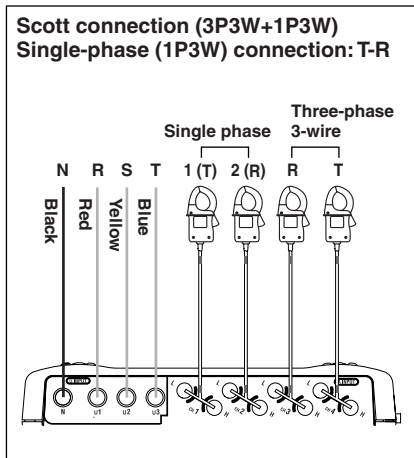
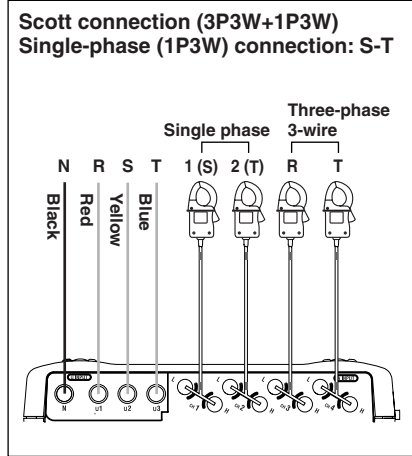
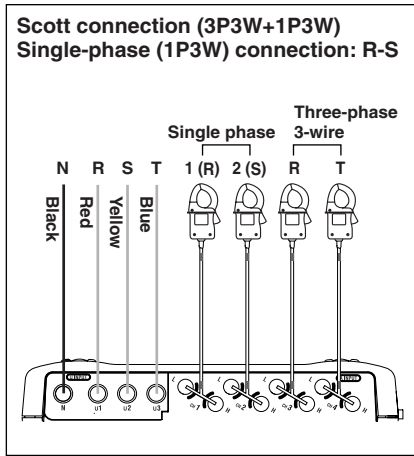

3.6 Turning ON the Power Switch

1 Model Name Screen

When the power switch is turned ON, the CW240 displays the following startup screen for approx. 2 seconds.

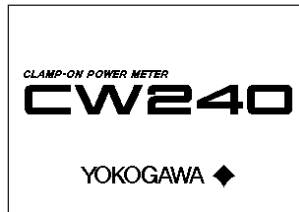

2 Message Screen

This screen displays the model, version number, the presence of options, and self-check results.

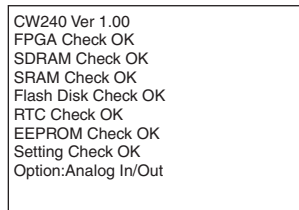

3 When the self-check has been completed normally, the screen displayed when you previously turned OFF the CW240 appears.

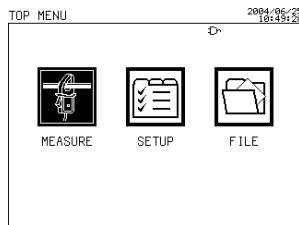

To switch to the Top Menu screen shown on the left, press the TOP MENU key.



● Description of the Message Screen

Indications		Description
1	CW240 VER 1.00	Model and version number
Self-check		
2	FPGA Check OK	FPGA check
3	SDRAM Check OK	SDRAM check
4	SRAM Check OK	SRAM check
5	Flash Disk Check OK	Check of the flash file system (internal memory)
6	RTC Check OK	Check of the real-time clock
7	EEPROM Check OK	EEPROM Check
8	Setting Check OK	Setting data check
9	Option:Analog In/Out	Option specifications The example shows the presence of analog I/O.

CAUTION

If an error is detected by the self-check (3 to 8 items), the information about the error is displayed. For countermeasures, see Chapter 16, Maintenance Troubleshooting.

3.7 Performing Measurements with Greater Precision

- After turning the power switch on, let the CW240 warm up (for more than 30 minutes) before starting to perform measurements.
- To perform measurements with higher precision, use the CW240 under the following environment conditions:
Ambient temperature: $23 \pm 5^{\circ}\text{C}$
Ambient humidity: 35 to 75% R.H (no condensation)

If the CW240 is installed in a location where the ambient humidity is less than 30%, use an antistatic mat, etc. to prevent electrostatic discharge.

If you move the CW240 from a location of low temperature and humidity to a location of high temperature and humidity or, if there is an abrupt change in the ambient temperature, condensation may occur in the CW240. If this happens, let the CW240 stand still for at least an hour to allow it to adapt to the new ambient temperature and for any condensation to dissolve. Then begin operating the CW240.

- Supply the power of sine waves at 50 Hz/60 Hz.
- When using a clamp-on probe, pay attention to the following points:
 - <1> When performing measurements, hold the clamp-on probe so that the conductor cable runs through the center of the clamping CT.
 - <2> Ensure that the orientation of the clamp to the direction of the conductor cable (from the power supply to the load) is correct, as shown on the right.
 - <3> Ensure that the clamping CT is properly closed.

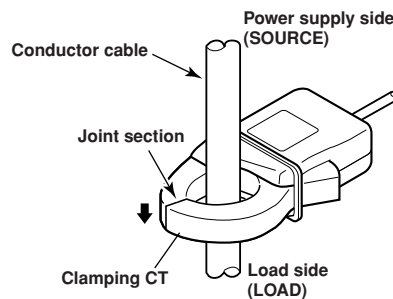

TIP

The CW240 obtains the measured value from voltage and current inputs.
(For computation equations, see Chapter 17, CW 240 Specifications.)

There may be cases where the CW240 shows a measurement value different from those obtained by other equipment with different operation principles or computation equations.

Chapter 4 Wiring

4.1	Precautions for Wiring to the Measurement Circuit	4-2
4.2	Installing the CW240	4-3
4.3	Setting up Wiring	4-5
4.4	Setting up the Number of Loads	4-6
4.5	Carrying out Wiring	4-7
4.6	Wiring the Measurement Circuit Using External VT/CT	4-23
4.7	Checking Wiring	4-24

4.1 Precautions for Wiring to the Measurement Circuit

WARNING

- Before carrying out wiring, be sure to read through 3.3, Connecting Voltage Probes, and 3.4, Connecting Clamp-on Probes.
- Do not apply an input exceeding the following value to the voltage input terminals.
 - Maximum allowable input : 1000 V rms
 - For measurement category III : 600 V rms
- The maximum allowable input and maximum operating circuit voltage of the clamp-on probes are as specified in the table below. Do not apply an input exceeding the relevant value or use the CW240 at a circuit voltage exceeding it.

Model	Current Rating	Maximum Allowable Input	Maximum Operating Circuit Voltage/ Measurement Category
96036	2 A	20 A	50 V/CAT.III
96033	50 A	60 A	300 V/CAT.III
96030	200 A	250 A	300 V/CAT.II, 600 V/CAT.II
96031	500 A	625 A	300 V/CAT.II, 600 V/CAT.II
96032	700 A (continuous) 1000 A (for 5 min)	700 A (continuous) 1000 A (for 5 min)	600 V
96034	1000/2000/3000 A	2400 A (continuous) 3600 A (for 10 min)	600 V/CAT.III
96035	300/3000 A	360/360 A	1000 V/CAT.III (area to be measured)

SEE ALSO

For more information, see Chapter 17, CW 240 Specifications.

WARNING

- If using an external VT (voltage transformer) or CT (current transformer), make sure the transformer can sufficiently withstand the voltage to be measured.
- Be careful not to allow the secondary side of CT to become open-circuited while the CT is being energized. Otherwise, a high voltage may develop on the secondary side, posing extreme risks.

4.2 Installing the CW240

Install the CW240 in locations meeting the following conditions:

- **Location**

Indoor

- **Ambient Temperature and Humidity**

- Ambient temperature : 5°C to 40°C
- Ambient humidity : 5 to 85% R.H
(no condensation)

- **Operating Altitude**

- 2000 m max. above sea level

- **Measurement Category (CAT.)**

The measurement category of the CW240 is III.

Measurement category		Remarks	Description
II	CAT.II	For measurements performed on circuits directly connected to the low voltage installation.	Appliances, portable equipments, etc.
III	CAT.III	For measurements performed in the building installation.	Distribution board, circuit breaker, etc.
IV	CAT.IV	For measurements performed at the source of the low-voltage installation.	Overhead wire, cable systems, etc.

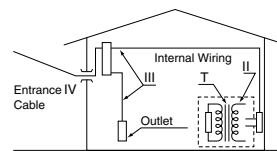

4.3 Installing the CW240

● Installation Category (CAT.)

The installation category of the CW240 is III.

Installation Category		Description
II	CAT.II	Applies to electrical equipment which is supplied from the fixed installation like distribution board.
III	CAT.III	Applies to electrical equipment which is power-supplied from a cable way ranging from the primary stage and branch point of equipment directly introducing electricity from a distribution board to the wall outlet.
IV	CAT.IV	Applies to electrical equipment which is power-supplied from a cable way ranging from the entrance cable of a building to a primary overcurrent protection.

● Pollution degree

The pollution degree of CW240 is 2.

“Pollution degree” describes the degree to which a solid, liquid, or gas which deteriorates dielectric strength or surface resistivity is adhering.

“2” applies to normal indoor atmosphere. Normally, only non-conductive pollution occurs. Occasionally, however, temporary conductivity caused by condensation must be expected.

● Level Location

Do not install the CW240 in an unstable or inclined location. Otherwise, it may fail to achieve precision measurements.

● Do not install the CW240 in a location that is:

- exposed to direct sunlight or close to a heat source,
- close to a noise source such as high-voltage equipment or a motive power supply,
- exposed to a relatively large amount of lampblack, steam, dust, corrosive gas,
- exposed to frequent mechanical vibration,
- close to a source of strong electromagnetic fields, or
- unstable.

WARNING

- **When using multiple CW240s, provide a space of at least 10 mm between the meters.**
 - **If the CW240 is installed in a switchboard, etc., provide a space of at least 10 mm from the wall. Also, provide space for wiring sections of terminals, etc. in consideration of protrusions such as plugs.**
-
-

4.3 Setting up Wiring

Wiring can be set up on the GENERAL 1/2 screen.

● General 1/2

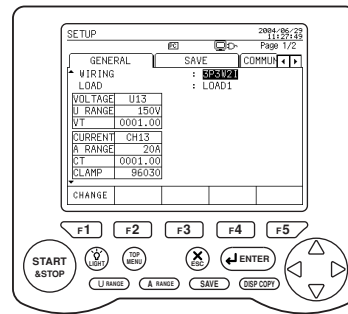
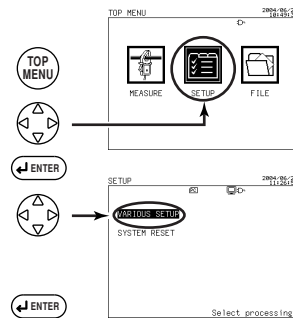

4 Wiring

● Changing Wiring

- 1 Using the Up and Down cursor key, select **WIRING** (highlighted).



- 2 Press the **F1** key (**CHANGE**).



The wiring selection window appears.

3P3W+1P3W	Scott connection
3P4W4I	Three-phase four-wire four-current
3P4W	Three-phase four-wire
3P3W3I	Three-phase three-wire three-current
3P3W2I	Three-phase three-wire two-current (Default)
1P3W3I	Single-phase three-wire three-current
1P3W	Single-phase three-wire
1P2W	Single-phase two-wire

- 3 Press the **ENTER** key.



This causes the wiring selection window to close, bringing you to the GENERAL screen.

The selected wiring is indicated.

SEE ALSO

For more information on settings, see Section 6.2, General Settings 1/2, in Chapter 6, Configuring Settings.

4.4 Setting up the Number of Loads

The number of loads can be set up on the GENERAL 1/2 screen.

● General 1/2

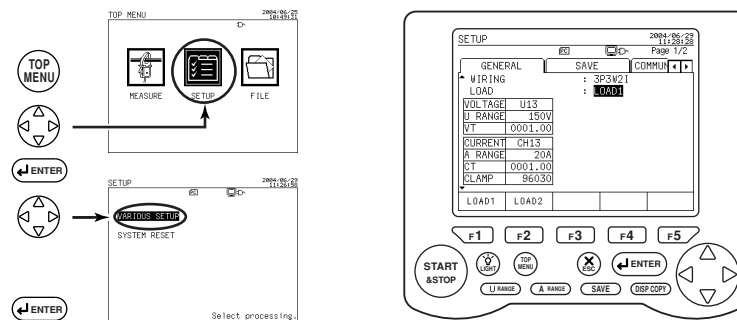

● Changing the Number of Loads

1 Using the Up and Down cursor key, select LOAD (highlighted).



The function key labels change.

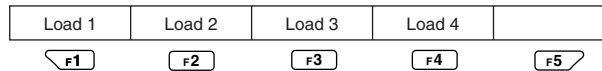

Default: Load 1

2 Set the number of loads using the corresponding function key.



● For Scott Connections

If wiring is set to 3P3W+1P3W(Scott connection), the setting of 1P connection is displayed (instead of the number of loads).

SEE ALSO

For more information on settings, see Section 6.2, General Settings 1/2, in Chapter 6, Configuring Settings.

4.5 Carrying out Wiring

WARNING

- When attaching voltage probes to or clamping a clamp-on probe on the circuit under test, turn off power to the circuit under test.
It is very dangerous to connect or disconnect a voltage probe or clamp or unclamp a clamp-on probe without turning off the circuit under test.
- Be sure to connect voltage probes to or clamp a clamp-on probe on the secondary side of the circuit under test, such as current limiters (circuit breakers). Should an accident such as a short occur, other circuits will be protected by these circuit breakers.

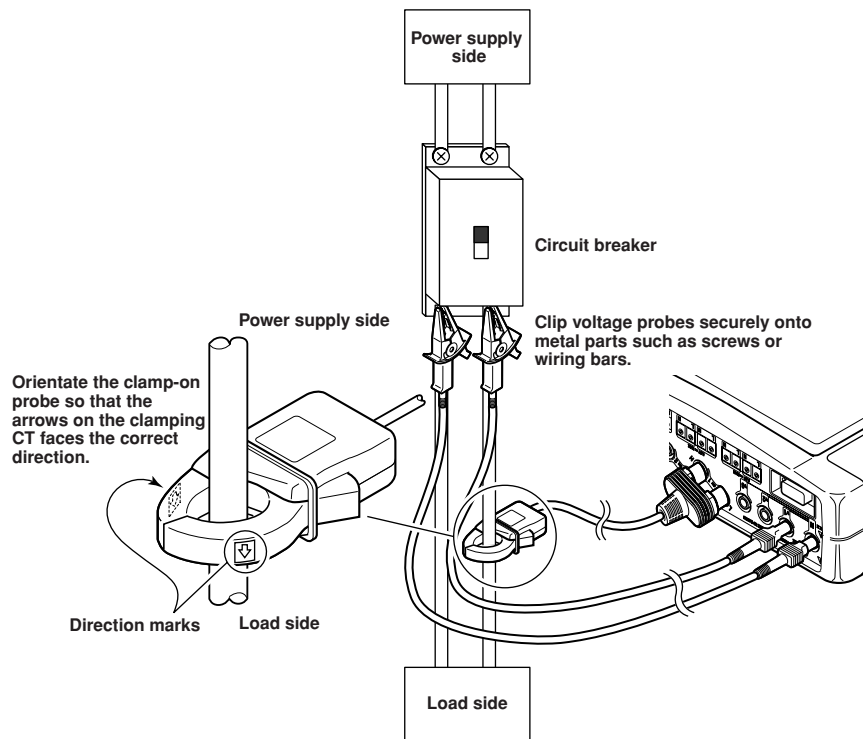

4.5 Carrying out Wiring

4.5.1 Single-phase Two-wire / Single Load (1P2W)

● WIRING DIAGRAM Screen

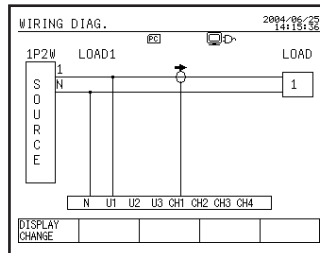

● WIRING CHECK Screen

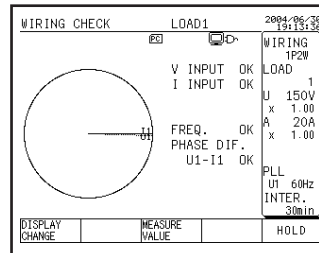

● Actual Wiring

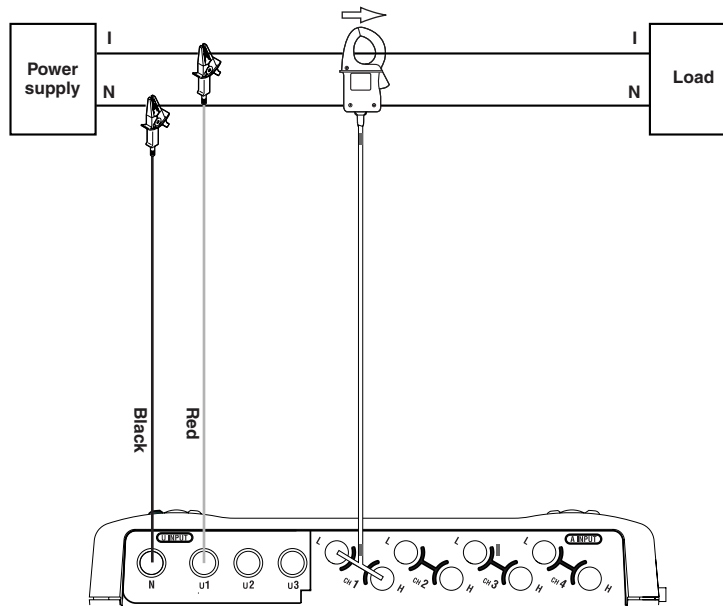

SEE ALSO

For more information on wiring checks, see Section 4.7, Checking Wiring.

4.5.2 Single-phase Two-wire / Two Loads (1P2W)

The CW240 can simultaneously measure multiple loads of the same power supply (voltage shared).

● **WIRING DIAGRAM Screen**

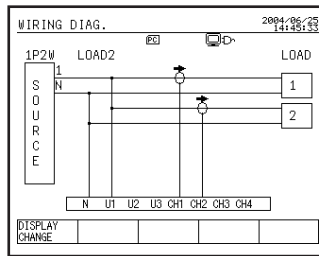

● **WIRING CHECK Screen**

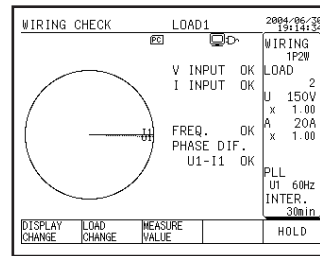

4
Wiring

● **Actual Wiring**

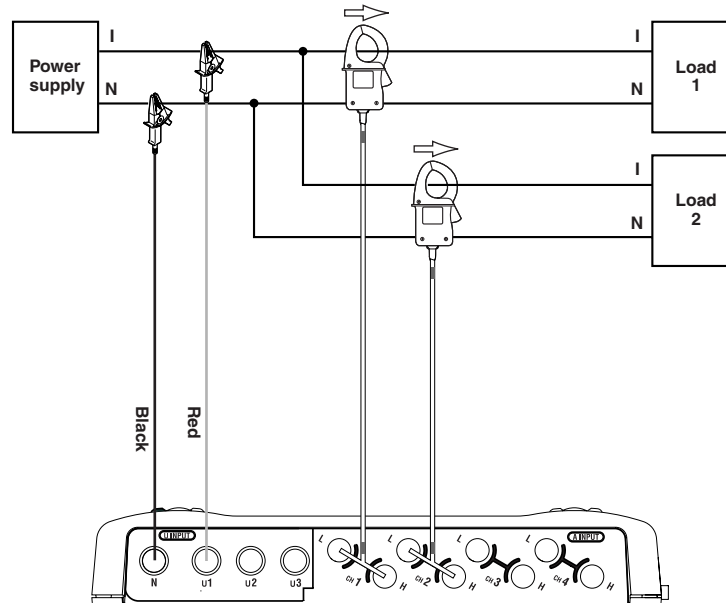

SEE ALSO

For more information on wiring checks, see Section 4.7, Checking Wiring.

4.5 Carrying out Wiring

4.5.3 Single-phase Two-wire / Three Loads (1P2W)

The CW240 can simultaneously measure multiple loads of the same power supply (voltage shared).

● WIRING DIAGRAM Screen

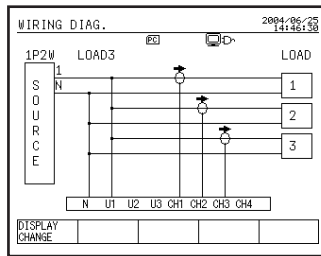

● WIRING CHECK Screen

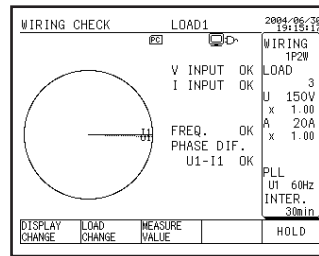

● Actual Wiring

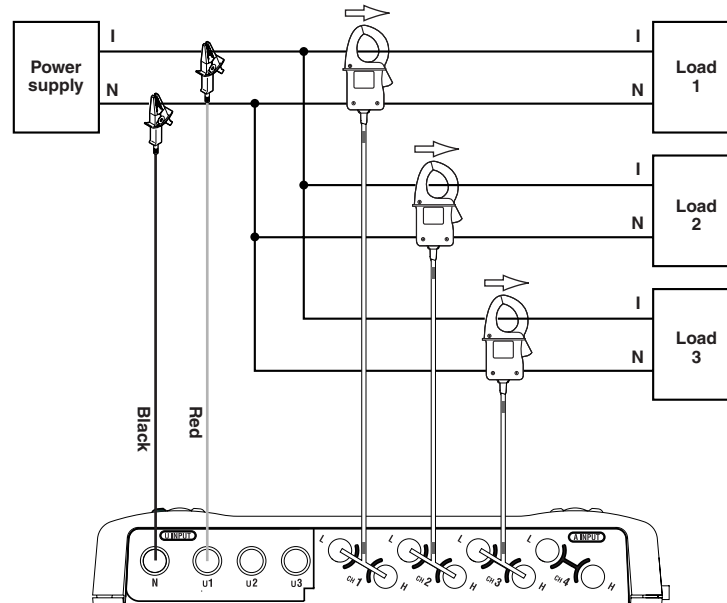

SEE ALSO

For more information on wiring checks, see Section 4.7, Checking Wiring.

4.5.4 Single-phase Two-wire / Four Loads (1P2W)

The CW240 can simultaneously measure multiple loads of the same power supply (voltage shared).

● **WIRING DIAGRAM Screen**

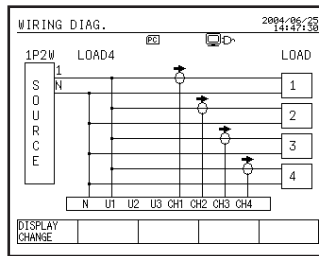

● **WIRING CHECK Screen**

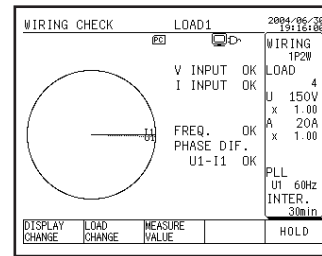

4
Wiring

● **Actual Wiring**

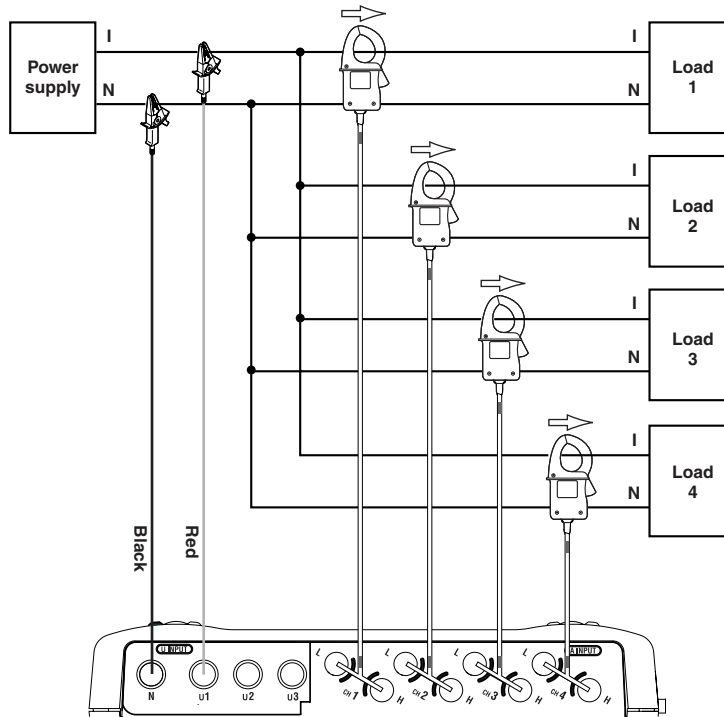

SEE ALSO

For more information on wiring checks, see Section 4.7, Checking Wiring.

4.5 Carrying out Wiring

4.5.5 Single-phase Three-wire / Single Load (1P3W)

● WIRING DIAGRAM Screen

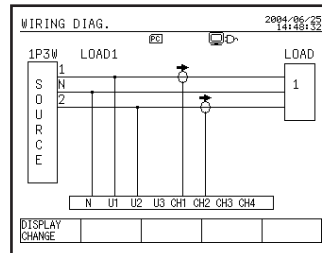

● WIRING CHECK Screen

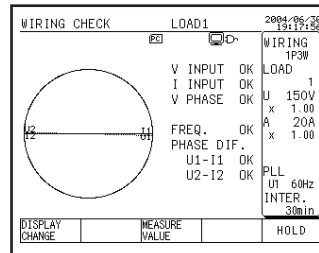

● Actual Wiring

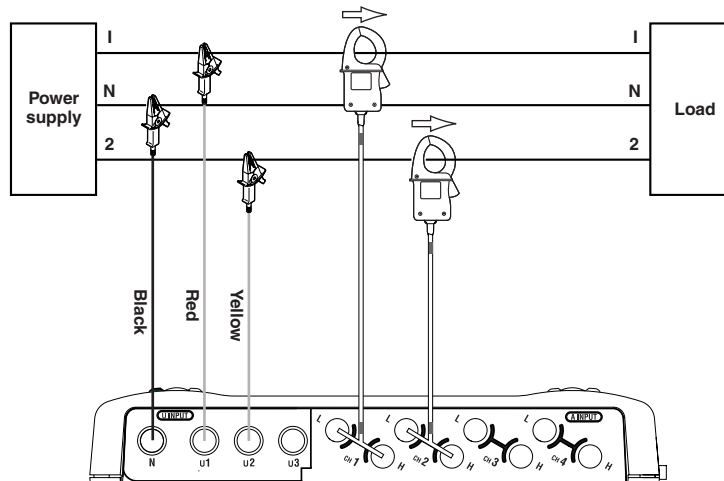

SEE ALSO

For more information on wiring checks, see Section 4.7, Checking Wiring.

4.5.6 Single-phase Three-wire / Two Loads (1P3W)

The CW240 can simultaneously measure multiple loads of the same power supply (voltage shared).

● **WIRING DIAGRAM Screen**

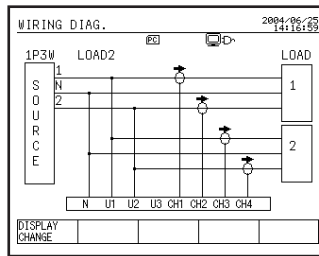

● **WIRING CHECK Screen**

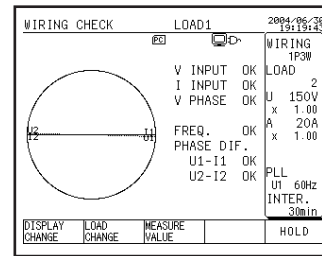

4
Wiring

● **Actual Wiring**

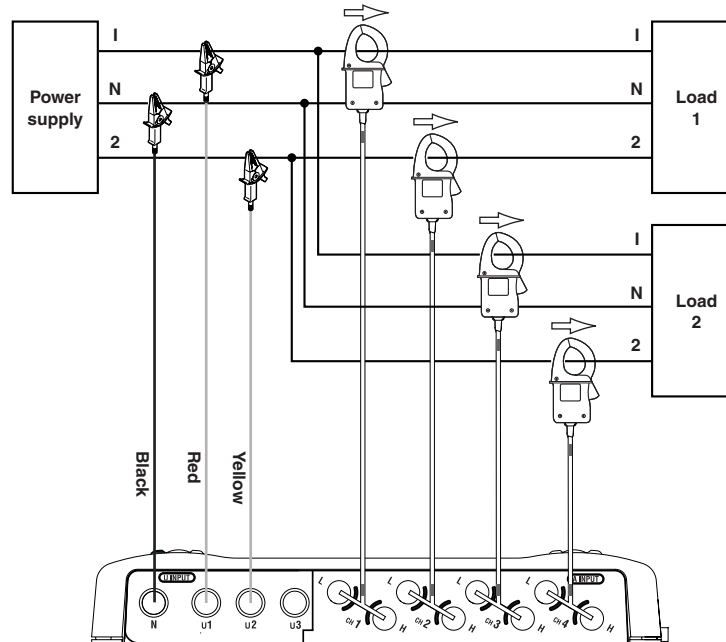

SEE ALSO

For more information on wiring checks, see Section 4.7, Checking Wiring.

4.5 Carrying out Wiring

4.5.7 Single-phase Three-wire Three-current (1P3W3I) <Measurement of neutral line current>

● WIRING DIAGRAM Screen

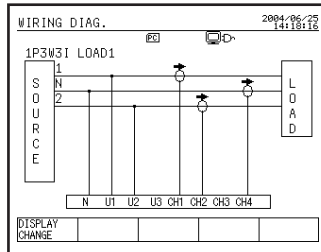

● WIRING CHECK Screen

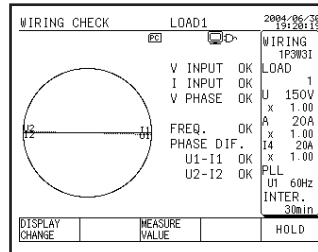

● Actual Wiring

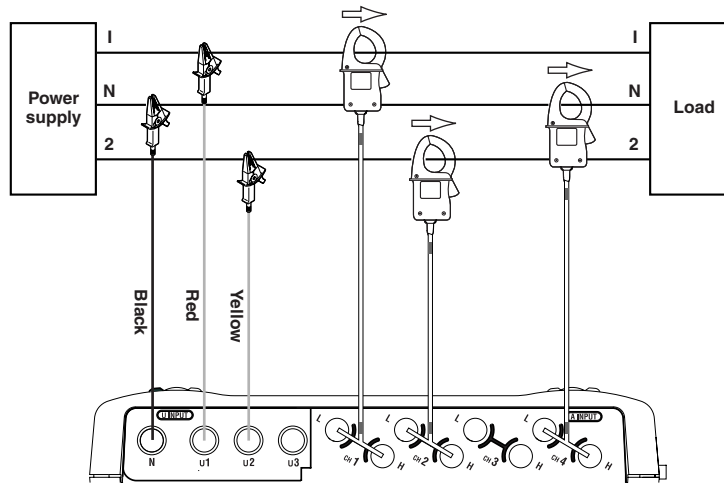

SEE ALSO

For more information on wiring checks, see Section 4.7, Checking Wiring.

4.5.8 Single-phase Three-wire Two-current / Single Load (3P3W2I)

<Two-power-meter method>

● WIRING DIAGRAM Screen

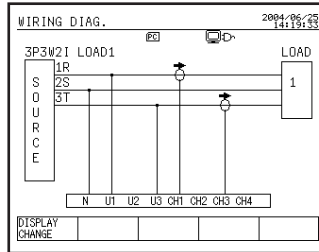

● WIRING CHECK Screen

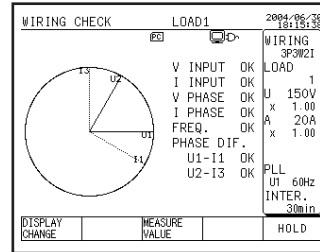

4
Wiring

● Actual Wiring

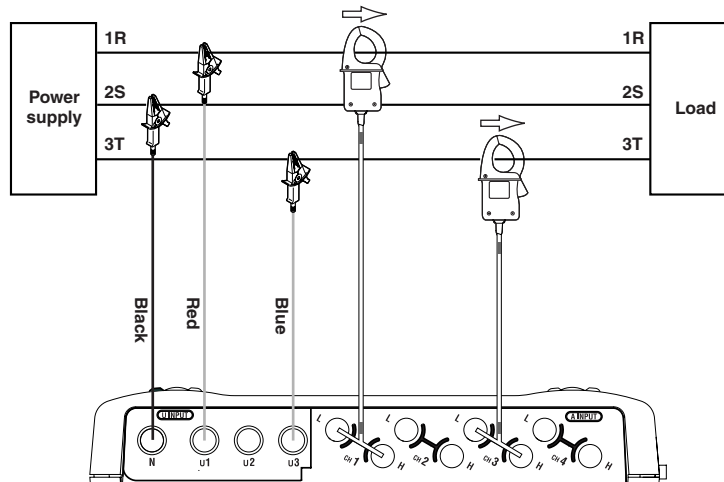

SEE ALSO

For more information on wiring checks, see Section 4.7, Checking Wiring.

4.5 Carrying out Wiring

4.5.9 Single-phase Three-wire Two-current / Two Loads (3P3W2I)

<Two-power-meter method>

The CW240 can simultaneously measure multiple loads of the same power supply (voltage shared).

● WIRING DIAGRAM Screen

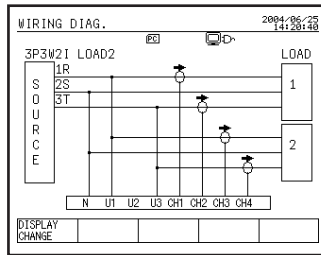

● WIRING CHECK Screen

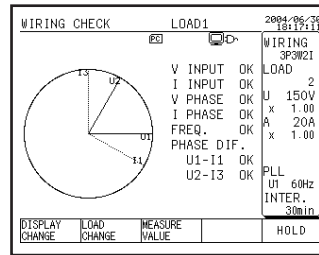

● Actual Wiring

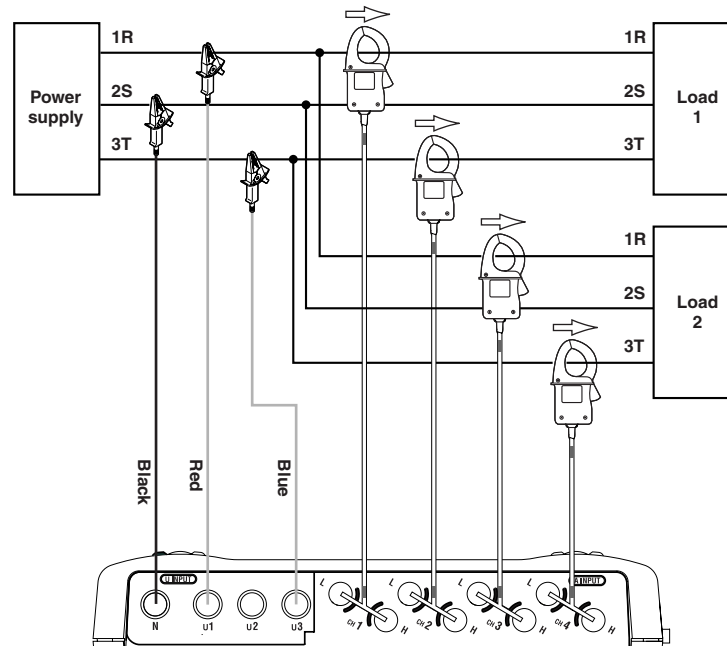

SEE ALSO

For more information on wiring checks, see Section 4.7, Checking Wiring.

**4.5.10 Three-phase Three-wire Three-current (3P3W3I)
<Three-power-meter method>**

● **WIRING DIAGRAM Screen**

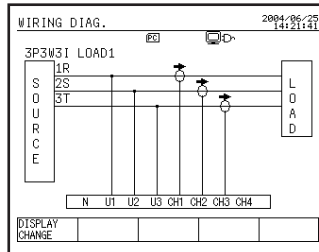

● **WIRING CHECK Screen**

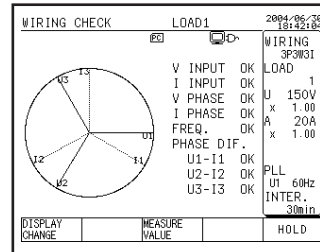

4
Wiring

● **Actual Wiring**

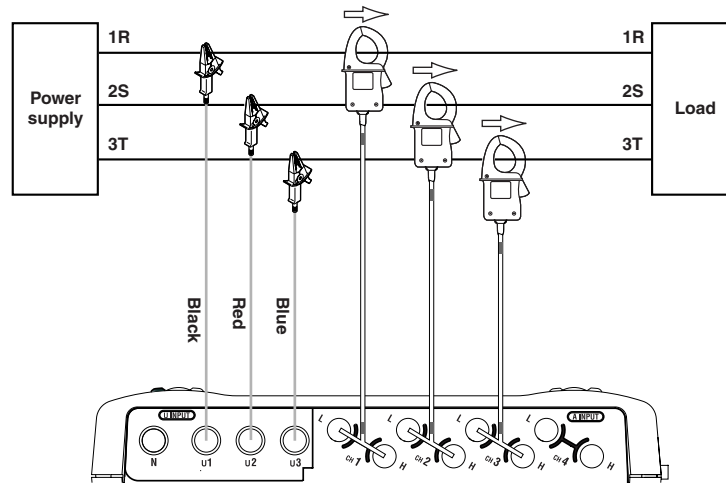

NOTE

Do not connect a wire to terminal N of the voltage input terminals.

SEE ALSO

For more information on wiring checks, see Section 4.7, Checking Wiring.

4.5 Carrying out Wiring

4.5.11 Three-phase Four-wire (3P4W)

● WIRING DIAGRAM Screen

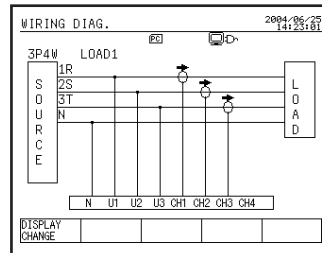

● WIRING CHECK Screen

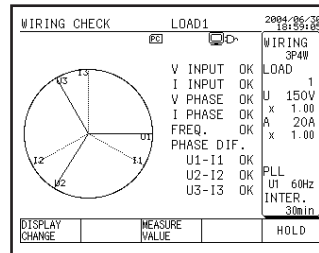

● Actual Wiring

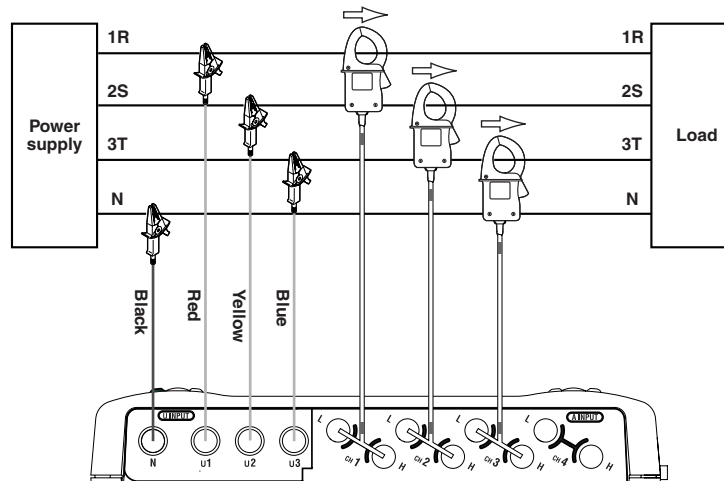

SEE- ALSO

For more information on wiring checks, see Section 4.7, Checking Wiring.

4.5.12 Three-phase Four-wire Four-current (3P4W4I)
<Measurement of neutral line current>

● **WIRING DIAGRAM Screen**

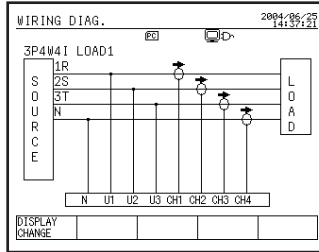

● **WIRING CHECK Screen**

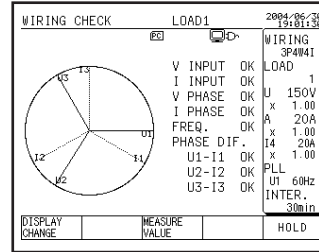

4
Wiring

● **Actual Wiring**

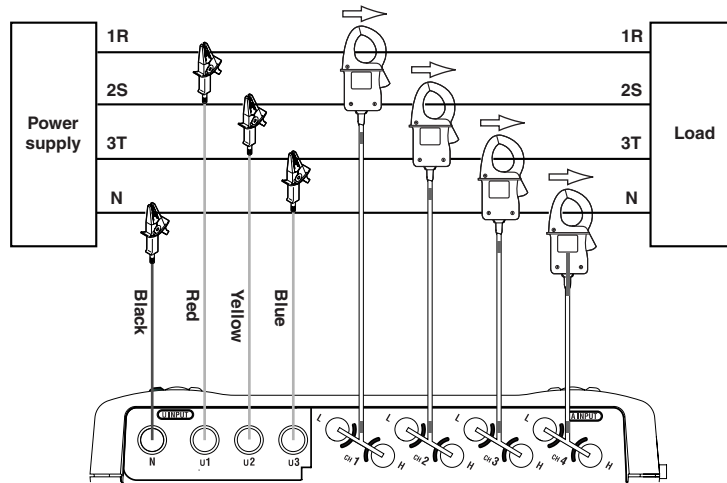

SEE ALSO

For more information on wiring checks, see Section 4.7, Checking Wiring.

4.5 Carrying out Wiring

4.5.13 Scott Connection (3P3W+1P3W)

Single phase (1P3W) connection: R-S

● WIRING DIAGRAM Screen

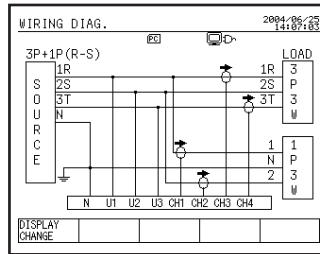

● WIRING CHECK Screen

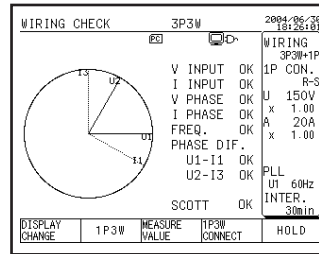

● Actual Wiring

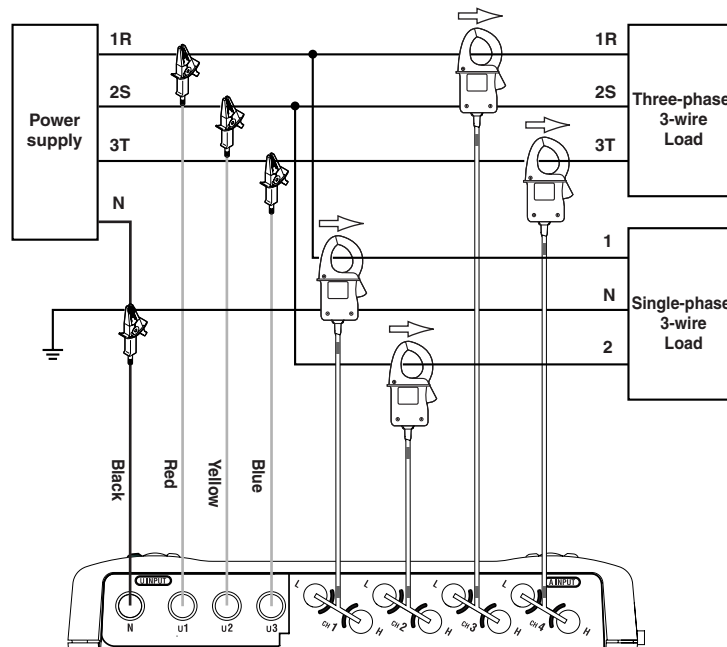

SEE ALSO

For more information on wiring checks, see Section 4.7, Checking Wiring.

4.5.14 Scott Connection (3P3W+1P3W)

Single phase (1P3W) connection: S-T

● WIRING DIAGRAM Screen

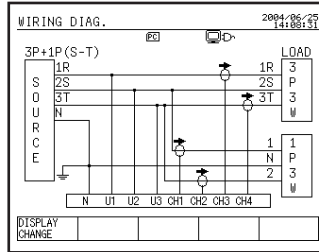

● WIRING CHECK Screen

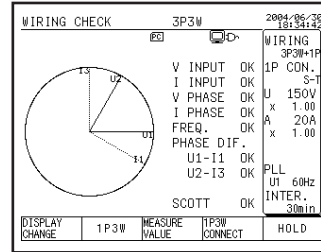

● Actual Wiring

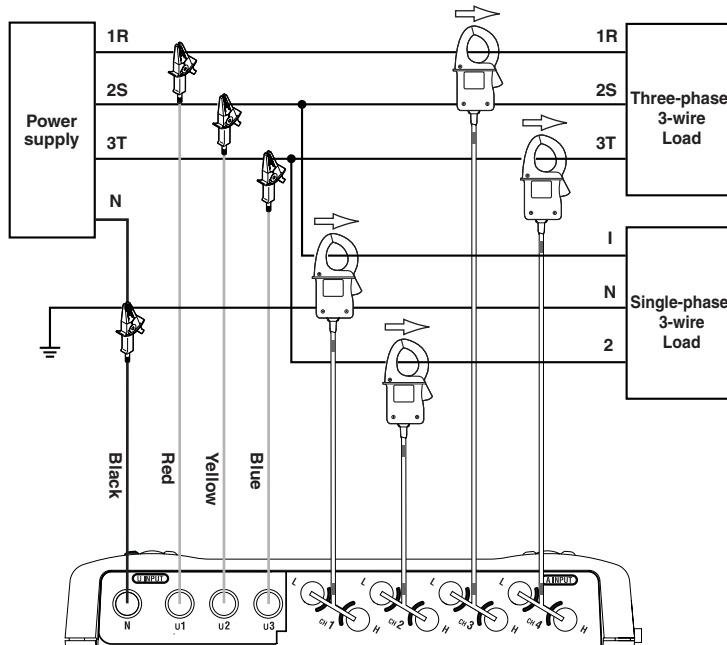

SEE ALSO

For more information on wiring checks, see Section 4.7, Checking Wiring.

4.5 Carrying out Wiring

4.5.15 Scott Connection (3P3W+1P3W)

Single phase (1P3W) connection: T-R

● WIRING DIAGRAM Screen

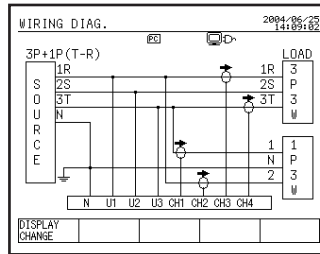

● WIRING CHECK Screen

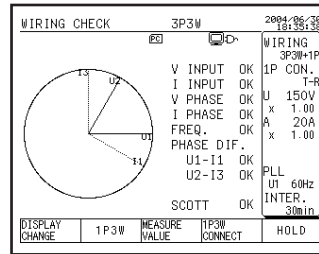

● Actual Wiring

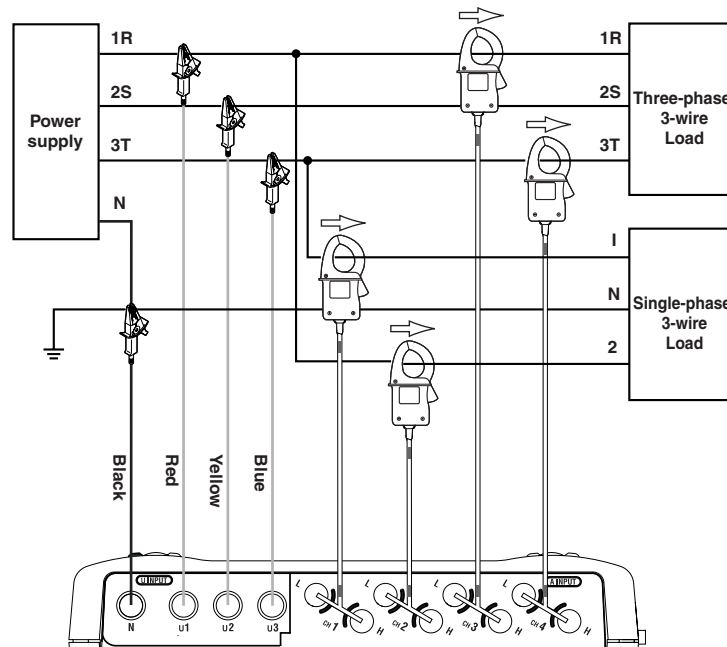

SEE ALSO

For more information on wiring checks, see Section 4.7, Checking Wiring.

4.6 Wiring the Measurement Circuit Using External VT/CT

WARNING

- When using an external CT, be careful not to allow the secondary side of the CT to become open-circuited while the primary side is being energized, otherwise, a high voltage may develop on the secondary side, posing extreme risks.
- The current under test flows through the thick lines shown in the figure below. For these, use wires that have an adequate margin of current-carrying capacity.

If the maximum voltage or current level of the circuit under test exceeds the maximum measurement range of the CW240, use an external VT and/or CT. This strategy enables the measurement of the voltage or current level.

Example of Single-phase 2-wire (1P2W)

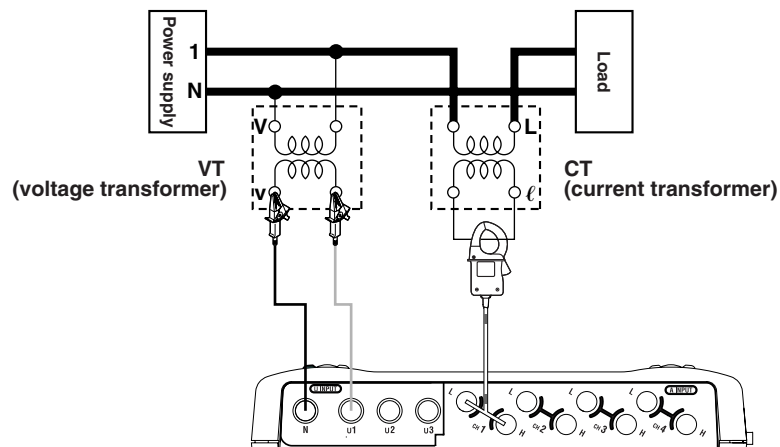

TIP

- If using VT and/or CT, setting the VT ratio and/or CT ratio allows the CW240 to display the primary-side value.
- When the secondary side of the CT is rated at 5 A, it is recommended that the 96033 (for 50 A) clamp-on probe be used in the 5 A range.

SEE ALSO

For how to set a VT or CT ratio, see 6.2.7, Setting Up VT Ratio and CT Ratio.

4.7 Checking Wiring

WARNING

Checking wiring is important for ensuring safe and accurate measurements. Refer to Chapters 3 and 4 to carry out the necessary precautions for safe measurement and ensure that the connections have been made correctly. Check that the connections of the voltage probes and the connector H/L orientation and measurement positions of the clamp-on probe are correct.

- Press the F1 key (DISPLAY CHANGE) on the MEASURE screen to select the WIRING CHECK screen.
- The following item is indicated on WIRING CHECK screen.
Rms value of voltage input and Current input, and phase angle and vector diagram related to U1.

<Measured value display>

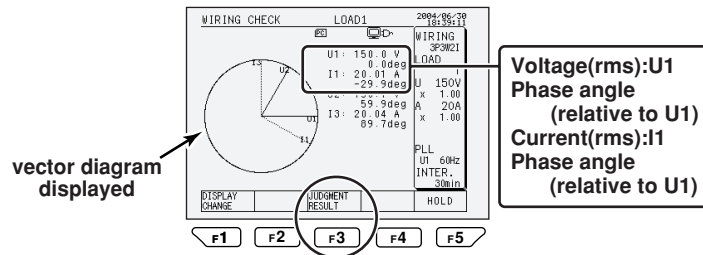

<Judgment result display>

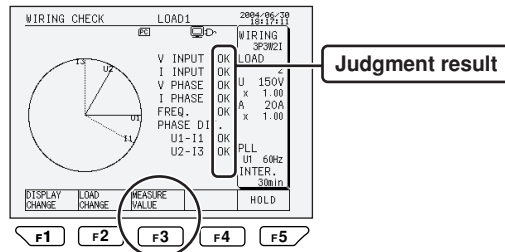

Use the **F3** key to switch between the measured value and judgment result displays.

To change the wiring to 3P3W+1P3W (Scott connection), press the F4 key to display the connection destination of a single-phase load.

 **NOTE**

- As the CW240 performs a wiring check based on the conditions shown below to judge if the wiring is accepted (OK) or rejected (NG), there may be cases where the result of the check may show what is actually correct wiring as NG and vice versa.

For this reason, also check for an error in the vector diagram or measured values.

- The rms values, phase angles, and vector diagram displayed are based on the fundamental components of voltage and current inputs.

● Wiring Check Items and Error Conditions - 1

Item	Error Conditions
Voltage input	10% or less of the rated range
Current input	1% or less of the rated range For 1P3W3I or 3P4W4I, I4 is not judged.
Phase difference (voltage - current)	<ul style="list-style-type: none"> • The result of voltage input judgment is NG. • For any system other than 3P3W2I or 3P3W3I: Each current does not fall within a range of $\pm 60^\circ$ based on each phase voltage • For 3P3W2I: I1 does not fall within a range of $+90^\circ$ to -30° relative to U1 I3 does not fall within a range of $+90^\circ$ to -30° relative to U2 • For 3P3W3I: Each current does not fall within a range of $+90^\circ$ to -30° based on each phase voltage • For Scott connections: A combination of single-phase 3-wire and three-phase 3-wire 2-current
Voltage phase	<ul style="list-style-type: none"> • The result of voltage input judgment is NG. • For 1P3W or 1P3W3I: U2 does not fall within a range of $180^\circ \pm 20\%$ with respect to U1. • For 3P3W2I: U2 leads U1 and does not fall within a range of 60° (leading) \pm approx. 20° relative to U1. • For 3P3W3I, 3P4W, or 3P4W4I: U2 lags behind U1 and does not fall within a range of 120° (lagging) \pm approx. 20° relative to U1, or U3 leads U1 and does not fall within a range of 120° (leading) \pm approx. 20° relative to U1.

4.7 Checking Wiring

● Wiring Check Items and Error Conditions - 2

Item	Error Conditions
Current phase	<ul style="list-style-type: none">• The result of current input judgment is NG.• For 3P3W2I: The phase of I3 lags behind that of I1.• For 3P3W3I, 3P4W, or 3P4W4I: The phase of I3 lags behind that of I1 or the phase of I2 leads that of I1.
Frequency source	<ul style="list-style-type: none">• Frequency measurement is unstable.• Input frequency is 40 Hz or less, or 70 Hz or more.
Scott connection	<p>When the connection setting of a single-phase, 3-wire load is set to:</p> <ul style="list-style-type: none">• R-S phase, $V1n+V2n = 10\%$ or more of voltage rating• S-T phase, $V2n+V3n = 10\%$ or more of voltage rating• T-R phase, $V3n+V1n = 10\%$ or more of voltage rating

● If the results of one or more wiring check are NG, check the following:

Results	Measures
Voltage input judgment is NG.	<ul style="list-style-type: none"> • Check if the voltage probes are connected properly to the circuit under test. • Check if the voltage probes are connected properly to the voltage input terminals of the product. • Check if the voltage range is appropriate to the input level.
Current input judgment is NG.	<ul style="list-style-type: none"> • Check if the clamp-on probe(s) is clamped onto the circuit under test properly. • Check if clamp-on probe(s) is connected to the current input terminal of the product properly. • Check if the current range is appropriate to the input level.
Phase difference judgment (voltage - current) is NG.	<ul style="list-style-type: none"> • Check if the voltage phase sequence is correct. • Check if the direction of the arrows and the phase of the clamp-on probe(s) are correct.
Voltage phase judgment is NG.	<ul style="list-style-type: none"> • Check if the voltage phase sequence is correct. • Check if the circuit under test and the setting of the wiring system agree with each other.
Current phase judgment is NG.	<ul style="list-style-type: none"> • Check if the direction of the arrows and the phase of the clamp-on probe(s) are correct. • Check if the circuit under test and the setting of the wiring system agree with each other.
Frequency source check is NG.	<ul style="list-style-type: none"> • Check if the voltage input selected for the frequency source is stable. • Check if the voltage probes selected for the frequency source are connected properly.
Scott connection check is NG.	<ul style="list-style-type: none"> • Check if the connection setting of the single-phase 3-wire load agrees with the circuit under test in the Scott connection. • Check if the voltage phase sequence is correct.

Chapter 5 Setting Ranges Using the Direct Keys

5.1	Setting the Voltage Range	5-2
5.2	Setting the Current Range	5-4
5.3	Ranges and Number of Digits	5-6

5.1 Setting the Voltage Range

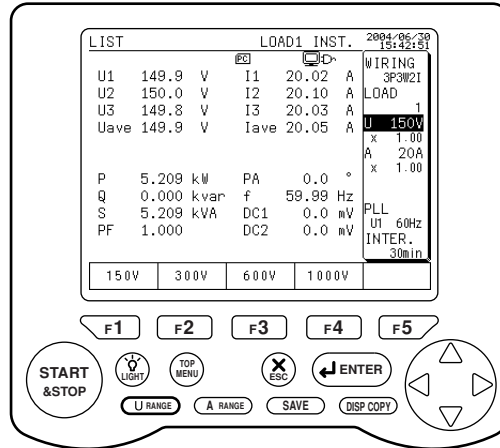

1 Voltage Range Direct Key

U RANGE

Press the **U RANGE** key once.

This causes the voltage range indication to be highlighted, changing the function key labels to voltage ranges.

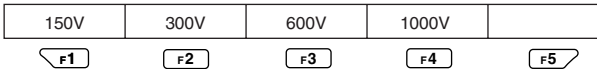

Default: 150 V

2 Setting the Voltage Range

F1 to **F4**

Press the corresponding function key to set the voltage range.

The voltage range changes to the selected one, returning the screen to the MEASURE screen.

TIP

If you do not want to change the voltage range, press the **U RANGE** key again or press the **ESC** key once. This causes the screen to return to the MEASURE screen.

 **NOTE**

If the result of "power rating \times VT ratio \times CT ratio \times 1.3" exceeds 999.9 TW, the voltage range cannot be changed. To change the voltage range in this case, modify other settings (wiring, current range, clamp-on probe type, VT ratio, and/or CT ratio) and then change it.

TIP

- A voltage range cannot be set during integration measurement (including when on standby).
 - A voltage range cannot be set in the VOLT. QUALITY or WIRING DIAG. screen.
 - If integral measured data has not been cleared, the voltage range cannot be set. To change the voltage range in this case, press the F5 key (HOLD/CLEAR) for more than 3 seconds on the MEASURE screen to clear integral measured data and then change it.
-

5.2 Setting the Current Range

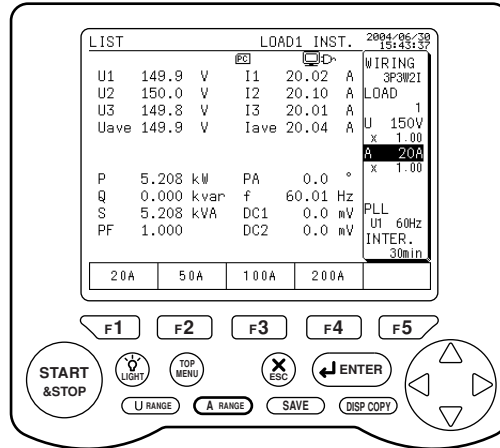

1 Current Range Direct Key

A RANGE Press the **A RANGE** key once.

This causes the current range indication to be highlighted, changing the function key labels to current ranges.

(The contents of the function key labels vary depending on the clamp-on probe to be used.)

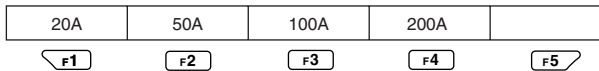

Default: 20 A (when clamp-on probe 96030 has been set)

The default is the minimum range of each clamp-on probe.

2 Setting the Current Range

F1 to **F4** Press the corresponding function key to set the current range.

The current range changes to the selected one, returning the screen to the MEASURE screen.

TIP

If you do not want to change the current range, press the **A RANGE** key again or press the **ESC** key once. This causes the screen to return to the MEASURE screen.

● Types of Clamp-on Probes and Current Ranges

Models of Clamp-on Probes	Function Keys			
	F1	F2	F3	F4
96036	200mA	500mA	1A	2A
96033	5A	10A	20A	50A
96030	20A	50A	100A	200A
96031	50A	100A	200A	500A
96032	200A	500A	1000A	
96034_1	300A	750A	1500A	3000A
96034_2	200A	500A	1000A	2000A
96034_3	100A	200A	500A	1000A
96035_1	300A	750A	1500A	3000A
96035_2	30A	75A	150A	300A

96034 or 96035: Current range is selected using the switch on a clamp-on current probe.

 **NOTE**

- The current ranges to be selected differ depending on the clamp-on current probe to be used.
- For measurements of multiple loads, a current range can be set for each load. For this, press the F2 key (LOAD CHANGE) to select the load for which you wish to change the current range and then set the current range.
- If the wiring system is 1P3W3I or 3P4W4I, you cannot use the A RANGE key to set the current range of I4. To set this current range, move to the SETUP screen and then set it.
- If the wiring system is a Scott connection, a current range can be set separately for the three-phase three-wire and single-phase three-wire sides. For this, press the F2 key (3P3W or 1P1W) to select the wiring for which you wish to change the current range and then set the current range.
- If the result of "power rating \times VT ratio \times CT ratio \times 1.3" exceeds 999.9 TW, the current range cannot be changed. To change the current range in this case, modify other settings (wiring, voltage range, clamp-on probe type, VT ratio, and/or CT ratio) and then change it.

TIP

- A current range cannot be set during integration measurement (including when on standby).
- A current range cannot be set in the VOLT. QUALITY or WIRING DIAG. screen.
- If integral measured data has not been cleared, the current range cannot be changed. To change the current range in this case, press the F5 key (HOLD/CLEAR) for more than 3 seconds on the MEASURE screen to clear integral measured data and then change it.

5.3 Ranges and Number of Digits

This section describes the voltage, current, power, and electric energy ranges.

● Voltage Ranges

150/300/600/1000 V

● Current Ranges

Current ranges vary depending on the clamp-on probe to be used.

Clamp-on Probe	Current Range			
96036	200mA	500mA	1A	2A
96033	5A	10A	20A	50A
96030	20A	50A	100A	200A
96031	50A	100A	200A	500A
96032	200A	500A	1000A	
96034_1	300A	750A	1500A	3000A
96034_2	200A	500A	1000A	2000A
96034_3	100A	200A	500A	1000A
96035_1	300A	750A	1500A	3000A
96035_2	30A	75A	150A	300A

96034 or 96035: Current range is selected using the switch on a clamp-on probe.

● Active and Reactive Power Ranges

The active and reactive power ranges are determined as shown below depending on the voltage range, current range, and/or wiring system (wiring).

Wiring System (Wiring)	Power Range
1P2W	Voltage range × current range
1P3W 1P3W3I 3P3W2I 3P3W3I 3P3W+1P3W*	Voltage range × current range × 2
3P4W 3P4W4I	Voltage range × current range × 3

*: Scott connection

5.3 Ranges and Number of Digits

● Active Power Range Configuration

Range Configurations 1 to 10 show the active power ranges corresponding to the voltage and current ranges. Each value in the table is its full scale value.

TIP

For reactive power or apparent power, the unit for the Range Configuration tables varies as follows:

- Reactive power (Var)
- Apparent power (VA)

If the VT ratio or CT ratio is set to any value other than "1":

A value obtained by multiplying a value in the Range Configuration tables by the VT or CT ratio applies.

If the result of "VT ratio × CT ratio × 1.3" exceeds 9999, the position of the decimal point is shifted by one digit.

Range Configuration 1 (Using clamp-on probe 96036)

Voltage Range	Wiring	96036			
		Current Range			
		200.0 mA	500.0 mA	1.000 A	2.000 A
150.0 V	1P2W	30.00 W	75.00 W	150.0 W	300.0 W
	1P3W	60.00 W	150.0 W	300.0 W	600.0 W
	3P3W	60.00 W	150.0 W	300.0 W	600.0 W
	3P4W	90.00 W	225.0 W	450.0 W	900.0 W
300.0 V	1P2W	60.00 W	150.0 W	300.0 W	600.0 W
	1P3W	120.0 W	300.0 W	600.0 W	1.200 kW
	3P3W	120.0 W	300.0 W	600.0 W	1.200 kW
	3P4W	180.0 W	450.0 W	900.0 W	1.800 kW
600.0 V	1P2W	120.0 W	300.0 W	600.0 W	1.200 kW
	1P3W	240.0 W	600.0 W	1.200 kW	2.400 kW
	3P3W	240.0 W	600.0 W	1.200 kW	2.400 kW
	3P4W	360.0 W	900.0 W	1.800 kW	3.600 kW
1.000 kV	1P2W	200.0 W	500.0 W	1.000 kW	2.000 kW
	1P3W	400.0 W	1.000 kW	2.000 kW	4.000 kW
	3P3W	400.0 W	1.000 kW	2.000 kW	4.000 kW
	3P4W	600.0 W	1.500 kW	3.000 kW	6.000 kW

5.3 Ranges and Number of Digits

Range Configuration 2 (Using clamp-on probe 96033)

Voltage Range	Wiring	96033			
		Current Range			
		5.000 A	10.00 A	20.00 A	50.00 A
150.0 V	1P2W	750.0 W	1.500 kW	3.000 kW	7.500 kW
	1P3W	1.500 kW	3.000 kW	6.000 kW	15.00 kW
	3P3W	1.500 kW	3.000 kW	6.000 kW	15.00 kW
	3P4W	2.250 kW	4.500 kW	9.000 kW	22.50 kW
300.0 V	1P2W	1.500 kW	3.000 kW	6.000 kW	15.00 kW
	1P3W	3.000 kW	6.000 kW	12.00 kW	30.00 kW
	3P3W	3.000 kW	6.000 kW	12.00 kW	30.00 kW
	3P4W	4.500 kW	9.000 kW	18.00 kW	45.00 kW
600.0 V	1P2W	3.000 kW	6.000 kW	12.00 kW	30.00 kW
	1P3W	6.000 kW	12.00 kW	24.00 kW	60.00 kW
	3P3W	6.000 kW	12.00 kW	24.00 kW	60.00 kW
	3P4W	9.000 kW	18.00 kW	36.00 kW	90.00 kW
1.000 kV	1P2W	5.000 kW	10.00 kW	20.00 kW	50.00 kW
	1P3W	10.00 kW	20.00 kW	40.00 kW	100.0 kW
	3P3W	10.00 kW	20.00 kW	40.00 kW	100.0 kW
	3P4W	15.00 kW	30.00 kW	60.00 kW	150.0 kW

Range Configuration 3 (Using clamp-on probe 96030)

Voltage Range	Wiring	96030			
		Current Range			
		20.00 A	50.00 A	100.0 A	200.0 A
150.0 V	1P2W	3.000 kW	7.500 kW	15.00 kW	30.00 kW
	1P3W	6.000 kW	15.00 kW	30.00 kW	60.00 kW
	3P3W	6.000 kW	15.00 kW	30.00 kW	60.00 kW
	3P4W	9.000 kW	22.50 kW	45.00 kW	90.00 kW
300.0 V	1P2W	6.000 kW	15.00 kW	30.00 kW	60.00 kW
	1P3W	12.00 kW	30.00 kW	60.00 kW	120.0 kW
	3P3W	12.00 kW	30.00 kW	60.00 kW	120.0 kW
	3P4W	18.00 kW	45.00 kW	90.00 kW	180.0 kW
600.0 V	1P2W	12.00 kW	30.00 kW	60.00 kW	120.0 kW
	1P3W	24.00 kW	60.00 kW	120.0 kW	240.0 kW
	3P3W	24.00 kW	60.00 kW	120.0 kW	240.0 kW
	3P4W	36.00 kW	90.00 kW	180.0 kW	360.0 kW
1.000 kV	1P2W	20.00 kW	50.00 kW	100.0 kW	200.0 kW
	1P3W	40.00 kW	100.0 kW	200.0 kW	400.0 kW
	3P3W	40.00 kW	100.0 kW	200.0 kW	400.0 kW
	3P4W	60.00 kW	150.0 kW	300.0 kW	600.0 kW

5.3 Ranges and Number of Digits

Range Configuration 4 (Using clamp-on probe 96031)

Voltage Range	Wiring	96031			
		Current Range			
		50.0 A	100.0 A	200.0 A	500.0 A
150.0 V	1P2W	7.500 kW	15.00 kW	30.00 kW	75.00 kW
	1P3W	15.00 kW	30.00 kW	60.00 kW	150.0 kW
	3P3W	15.00 kW	30.00 kW	60.00 kW	150.0 kW
	3P4W	22.50 kW	45.00 kW	90.00 kW	225.0 kW
300.0 V	1P2W	15.00 kW	30.00 kW	60.00 kW	150.0 kW
	1P3W	30.00 kW	60.00 kW	120.0 kW	300.0 kW
	3P3W	30.00 kW	60.00 kW	120.0 kW	300.0 kW
	3P4W	45.00 kW	90.00 kW	180.0 kW	450.0 kW
600.0 V	1P2W	30.00 kW	60.00 kW	120.0 kW	300.0 kW
	1P3W	60.00 kW	120.0 kW	240.0 kW	600.0 kW
	3P3W	60.00 kW	120.0 kW	240.0 kW	600.0 kW
	3P4W	90.00 kW	180.0 kW	360.0 kW	900.0 kW
1.000 kV	1P2W	50.00 kW	100.0 kW	200.0 kW	500.0 kW
	1P3W	100.0 kW	200.0 kW	400.0 kW	1.000 MW
	3P3W	100.0 kW	200.0 kW	400.0 kW	1.000 MW
	3P4W	150.0 kW	300.0 kW	600.0 kW	1.500 MW

Range Configuration 5 (Using clamp-on probe 96032)

Voltage Range	Wiring	96032		
		Current Range		
		200.0 A	500.0 A	1.000 kA
150.0 V	1P2W	30.00 kW	75.00 kW	150.0 kW
	1P3W	60.00 kW	150.0 kW	300.0 kW
	3P3W	60.00 kW	150.0 kW	300.0 kW
	3P4W	90.00 kW	225.0 kW	450.0 kW
300.0 V	1P2W	60.00 kW	150.0 kW	300.0 kW
	1P3W	120.0 kW	300.0 kW	600.0 kW
	3P3W	120.0 kW	300.0 kW	600.0 kW
	3P4W	180.0 kW	450.0 kW	900.0 kW
600.0 V	1P2W	120.0 kW	300.0 kW	600.0 kW
	1P3W	240.0 kW	600.0 kW	1.200 MW
	3P3W	240.0 kW	600.0 kW	1.200 MW
	3P4W	360.0 kW	900.0 kW	1.800 MW
1.000 kV	1P2W	200.0 kW	500.0 kW	1.000 MW
	1P3W	400.0 kW	1.000 MW	2.000 MW
	3P3W	400.0 kW	1.000 MW	2.000 MW
	3P4W	600.0 kW	1.500 MW	3.000 MW

5.3 Ranges and Number of Digits

Range Configuration 6 (Using clamp-on probe 96034)

Voltage Range	Wiring	96034_1			
		Current Range			
		300.0 A	750.0 A	1.500 kA	3.000 kA
150.0 V	1P2W	45.00 kW	112.5 kW	225.0 kW	450.0 kW
	1P3W	90.00 kW	225.0 kW	450.0 kW	900.0 kW
	3P3W	90.00 kW	225.0 kW	450.0 kW	900.0 kW
	3P4W	135.0 kW	337.5 kW	675.0 kW	1.350 MW
300.0 V	1P2W	90.00 kW	225.0 kW	450.0 kW	900.0 kW
	1P3W	180.0 kW	450.0 kW	900.0 kW	1.800 MW
	3P3W	180.0 kW	450.0 kW	900.0 kW	1.800 MW
	3P4W	270.0 kW	675.0 kW	1.350 MW	2.700 MW
600.0 V	1P2W	180.0 kW	450.0 kW	900.0 kW	1.800 MW
	1P3W	360.0 kW	900.0 kW	1.800 MW	3.600 MW
	3P3W	360.0 kW	900.0 kW	1.800 MW	3.600 MW
	3P4W	540.0 kW	1.350 MW	2.700 MW	5.400 MW
1.000 kV	1P2W	300.0 kW	750.0 kW	1.500 MW	3.000 MW
	1P3W	600.0 kW	1.500 MW	3.000 MW	6.000 MW
	3P3W	600.0 kW	1.500 MW	3.000 MW	6.000 MW
	3P4W	900.0 kW	2.250 MW	4.500 MW	9.000 MW

The model 96034 clamp-on probes allow a current range to be selected using a switch.
Model 96034_1 has a 3000 A range.

Range Configuration 7 (Using clamp-on probe 96034)

Voltage Range	Wiring	96034_2			
		Current Range			
		200.0 A	500.0 A	1.000 kA	2.000 kA
150.0 V	1P2W	30.00 kW	75.00 kW	150.0 kW	300.0 kW
	1P3W	60.00 kW	150.0 kW	300.0 kW	600.0 kW
	3P3W	60.00 kW	150.0 kW	300.0 kW	600.0 kW
	3P4W	90.00 kW	225.0 kW	450.0 kW	900.0 kW
300.0 V	1P2W	60.00 kW	150.0 kW	300.0 kW	600.0 kW
	1P3W	120.0 kW	300.0 kW	600.0 kW	1.200 MW
	3P3W	120.0 kW	300.0 kW	600.0 kW	1.200 MW
	3P4W	180.0 kW	450.0 kW	900.0 kW	1.800 MW
600.0 V	1P2W	120.0 kW	300.0 kW	600.0 kW	1.200 MW
	1P3W	240.0 kW	600.0 kW	1.200 MW	2.400 MW
	3P3W	240.0 kW	600.0 kW	1.200 MW	2.400 MW
	3P4W	360.0 kW	900.0 kW	1.800 MW	3.600 MW
1.000 kV	1P2W	200.0 kW	500.0 kW	1.000 MW	2.000 MW
	1P3W	400.0 kW	1.000 MW	2.000 MW	4.000 MW
	3P3W	400.0 kW	1.000 MW	2.000 MW	4.000 MW
	3P4W	600.0 kW	1.500 MW	3.000 MW	6.000 MW

The model 96034 clamp-on probes allow a current range to be selected using a switch.
Model 96034_2 has a 2000 A range.

5.3 Ranges and Number of Digits

Range Configuration 8 (Using clamp-on probe 96034)

Voltage Range	Wiring	96034_3			
		Current Range			
		100.0 A	200.0 A	500.0 A	1.000 kA
150.0 V	1P2W	15.00 kW	30.00 kW	75.00 kW	150.0 kW
	1P3W	30.00 kW	60.00 kW	150.0 kW	300.0 kW
	3P3W	30.00 kW	60.00 kW	150.0 kW	300.0 kW
	3P4W	45.00 kW	90.00 kW	225.0 kW	450.0 kW
300.0 V	1P2W	30.00 kW	60.00 kW	150.0 kW	300.0 kW
	1P3W	60.00 kW	120.0 kW	300.0 kW	600.0 kW
	3P3W	60.00 kW	120.0 kW	300.0 kW	600.0 kW
	3P4W	90.00 kW	180.0 kW	450.0 kW	900.0 kW
600.0 V	1P2W	60.00 kW	120.0 kW	300.0 kW	600.0 kW
	1P3W	120.0 kW	240.0 kW	600.0 kW	1.200 MW
	3P3W	120.0 kW	240.0 kW	600.0 kW	1.200 MW
	3P4W	180.0 kW	360.0 kW	900.0 kW	1.800 MW
1.000 kV	1P2W	100.0 kW	200.0 kW	500.0 kW	1.000 MW
	1P3W	200.0 kW	400.0 kW	1.000 MW	2.000 MW
	3P3W	200.0 kW	400.0 kW	1.000 MW	2.000 MW
	3P4W	300.0 kW	600.0 kW	1.500 MW	3.000 MW

The model 96034 clamp-on probes allow a current range to be selected using a switch.
Model 96034_3 has a 1000 A range.

Range Configuration 9 (Using clamp-on probe 96035)

Voltage Range	Wiring	96035_1			
		Current Range			
		300.0 A	750.0 A	1.500 kA	3.000 kA
150.0 V	1P2W	45.00 kW	112.5 kW	225.0 kW	450.0 kW
	1P3W	90.00 kW	225.0 kW	450.0 kW	900.0 kW
	3P3W	90.00 kW	225.0 kW	450.0 kW	900.0 kW
	3P4W	135.0 kW	337.5 kW	675.0 kW	1.350 MW
300.0 V	1P2W	90.00 kW	225.0 kW	450.0 kW	900.0 kW
	1P3W	180.0 kW	450.0 kW	900.0 kW	1.800 MW
	3P3W	180.0 kW	450.0 kW	900.0 kW	1.800 MW
	3P4W	270.0 kW	675.0 kW	1.350 MW	2.700 MW
600.0 V	1P2W	180.0 kW	450.0 kW	900.0 kW	1.800 MW
	1P3W	360.0 kW	900.0 kW	1.800 MW	3.600 MW
	3P3W	360.0 kW	900.0 kW	1.800 MW	3.600 MW
	3P4W	540.0 kW	1.350 MW	2.700 MW	5.400 MW
1.000 kV	1P2W	300.0 kW	750.0 kW	1.500 MW	3.000 MW
	1P3W	600.0 kW	1.500 MW	3.000 MW	6.000 MW
	3P3W	600.0 kW	1.500 MW	3.000 MW	6.000 MW
	3P4W	900.0 kW	2.250 MW	4.500 MW	9.000 MW

The model 96035 clamp-on probes allow a current range to be selected using a switch.
Model 96035_1 has a 3000 A range.

5.3 Ranges and Number of Digits

Range Configuration 10 (Using clamp-on probe 96035)

Voltage Range	Wiring	96035_2			
		Current Range			
		30.00 A	75.00 A	150.0 A	300.0 A
150.0 V	1P2W	4.500 kW	11.25 kW	22.50 kW	45.00 kW
	1P3W	9.000 kW	22.50 kW	45.00 kW	90.00 kW
	3P3W	9.000 kW	22.50 kW	45.00 kW	90.00 kW
	3P4W	13.50 kW	33.75 kW	67.50 kW	135.0 kW
300.0 V	1P2W	9.000 kW	22.50 kW	45.0 kW	90.00 kW
	1P3W	18.00 kW	45.00 kW	90.0 kW	180.0 kW
	3P3W	18.00 kW	45.00 kW	90.0 kW	180.0 kW
	3P4W	27.00 kW	67.50 kW	135.0 kW	270.0 kW
600.0 V	1P2W	18.00 kW	45.00 kW	90.00 kW	180.0 kW
	1P3W	36.00 kW	90.00 kW	180.0 kW	360.0 kW
	3P3W	36.00 kW	90.00 kW	180.0 kW	360.0 kW
	3P4W	54.00 kW	135.0 kW	270.0 kW	540.0 kW
1.000 kV	1P2W	30.00 kW	75.00 kW	150.0 kW	300.0 kW
	1P3W	60.00 kW	150.0 kW	300.0 kW	600.0 kW
	3P3W	60.00 kW	150.0 kW	300.0 kW	600.0 kW
	3P4W	90.00 kW	225.0 kW	450.0 kW	900.0 kW

The model 96035 clamp-on probes allow a current range to be selected using a switch.

Model 96035_2 has a 3000 A range.

● Display Digits

The display digits, position of the decimal point, and unit of measurement are as shown in the tables below. The maximum number of digits that can be displayed for voltage, current, power, frequency, power factor, and phase angle is 9999 (4 digits).

Voltage

Range × CT ratio (× 1.3)*	Position of decimal point and unit
1.95 to 9.999 V	9.999 V
10 to 99.99 V	99.99 V
100 to 999.9 V	999.9 V
1 to 9.999 kV	9.999 kV
10 to 99.99 kV	99.99 kV
100 to 999.9 kV	999.9 kV
1 to 9.999 MV	9.999 MV

5.3 Ranges and Number of Digits

Current

Range × CT ratio (× 1.3)*	Position of decimal point and unit
1.3 to 9.999 mA	9.999 mA
10 to 99.99 mA	99.99 mA
100 to 999.9 mA	999.9 mA
1 to 9.999 A	9.999 A
10 to 99.99 A	99.99 A
100 to 999.9 A	999.9 A
1 to 9.999 kA	9.999 kA
10 to 99.99 kA	99.99 kA
100 to 999.9 kA	999.9 kA
1 to 9.999 MA	9.999 MA
10 to 99.99 MA	99.99 MA
100 to 999.9 MA	999.9 MA

Power

Rated power × VT ratio × CT ratio (× 1.3)*	Position of decimal point and unit
1.95 to 9.999 mW	9.999 mW
10 to 99.99 mW	99.99 mW
100 to 999.9 mW	999.9 mW
1 to 9.999 W	9.999 W
10 to 99.99 W	99.99 W
100 to 999.9 W	999.9 W
1 to 9.999 kW	9.999 kW
10 to 99.99 kW	99.99 kW
100 to 999.9 kW	999.9 kW
1 to 9.999 MW	9.999 MW
10 to 99.99 MW	99.99 MW
100 to 999.9 MW	999.9 MW
1 to 9.999 GW	9.999 GW
10 to 99.99 GW	99.99 GW
100 to 999.9 GW	999.9 GW
1 to 9.999 TW	9.999 TW
10 to 99.99 TW	99.99 TW
100 to 999.9 TW	999.9 TW

* : If the VT ratio or CT ratio is any value other than "1" :

A vale obtained by multiplying a value in the table by the VT or CT ratio applies.

5.3 Ranges and Number of Digits

Frequency

Input frequency	Position of decimal point and unit
40 to 70 Hz	99.99 Hz

Power Factor

Measurement range	Position of decimal point
-1.000 to 0 to 1.000	1.000

Phase Angle

Measurement range	Position of decimal point and unit
-180.0 to 180.0°	180.0

● Electric Energy (Position of Decimal Point and unit)

The position of the decimal point and the unit of measurement for electric energy can be set. This can be done by following GENERAL 2/2 of the SETUP screen.

Setting Item	Description
Electric energy display [wh DISPLAY]	Set the position of the decimal point and the unit of measurement for integrated electric energy.
Unit of electric energy [ELECTRIC ENERGY INDICATION UNIT]	
Interval electric energy display [INTERVAL] [Wh DISP.]	For demand measurements: Set the position of the decimal point and the unit of measurement for interval electric energy.
Unit of interval electric energy [INTERVAL ELECTRIC ENERGY INDICATION UNIT]	

Contents of Settings

STANDARD	Determines and fixes the position of the decimal point and the unit of measurement automatically according to the rated power. (Table 1)
AUTO	Shifts the position of the decimal point automatically (the unit of measurement also changes). (Table 2)
Setting of decimal point position	000.000/0000.00/00000.0/000000
Setting of measurement unit	mWh/Wh/kWh/MWh/GWh

The maximum number of displayable digits for electric energy is 999999 (6 digits).

5.3 Ranges and Number of Digits

STANDARD

When you select STANDARD, the position of the decimal point and the unit of measurement are as shown in the table below.

Table 1

Rated power × VT ratio × CT ratio (× interval time: h) *1	Position of decimal point and unit
1.5 to 9.999 mW	0.0 to 9999.99 mWh
10 to 99.99 mW	0.0 to 99999.9 mWh
100 to 999.9 mW	0.000 to 999.999 mWh
1 to 9.999 W	0.00 to 9999.99 Wh
10 to 99.99 W	0.0 to 99999.9 Wh
100 to 999.9 W	0.000 to 999.999 Wh
1 to 9.999 kW	0.00 to 9999.99 kWh
10 to 99.99 kW	0.0 to 99999.9 kWh
100 to 999.9 kW	0.000 to 999.999 kWh
1 to 9.999 MW	0.00 to 9999.99 MWh
10 to 99.99 MW	0.0 to 99999.9 MWh
100 to 999.9 MW	0.000 to 999.999 MWh
1 to 9.999 GW	0.00 to 9999.99 GWh
10 to 99.99 GW	0.0 to 99999.9 GWh
100 to 999.9 GW	0 to 999999 GWh
1 to 9.999 TW	0 to 999999 GWh
10 to 99.99 TW	0 to 999999 GWh
100 to 999.9 TW	0 to 999999 GWh

*1: Interval electric energy in demand measurements is calculated by multiplying by interval time (unit: h) in addition.

TIP

If the measured value exceeds the maximum displayed value, the reading will be reset to zero, letting integration continue.

5.3 Ranges and Number of Digits

AUTO

When AUTO is selected, the position of the decimal point and the unit of measurement change as follows:

The maximum number of digits that can be displayed for integrated electric energy is 999999 (6 digits). If electric energy is added to make it 1000000 (7 digits), the position of the decimal point will be moved automatically (the unit of measurement also changes automatically).

Example:

9.99999 mWh → 10.0000 mWh
 99.9999 Wh → 100.000 Wh
 999.999 mWh → 1.00000 Wh
 999.999 Wh → 1.00000 kWh

The start value for integration has been specified as shown below according to the rated power value.

Table 2

Rated power × VT ratio × CT ratio	Start value for integration of electric energy
1.5 to 9.999 mW	0.00000 to mWh
10 to 99.99 mW	0.0000 to mWh
100 to 999.9 mW	0.000 to mWh
1 to 9.999 W	0.00000 to Wh
10 to 99.99 W	0.0000 to Wh
100 to 999.9 W	0.000 to Wh
1 to 9.999 kW	0.00000 to kWh
10 to 99.99 kW	0.0000 to kWh
100 to 999.9 kW	0.000 to kWh
1 to 9.999 MW	0.00000 to MWh
10 to 99.99 MW	0.0000 to MWh
100 to 999.9 MW	0.000 to MWh
1 to 9.999 GW	0.00000 to GWh
10 to 99.99 GW	0.0000 to GWh
100 to 999.9 GW	0.000 to GWh
1 to 9.999 TW	0.00 to GWh
10 to 99.99 TW	0.0 to GWh
100 to 999.9 TW	0 to GWh

TIP

If an integrated value exceeds the maximum displayable integrated value (999999 GWh), the reading will be reset to an integration start value (zero), letting integration continue.

Chapter 6 Configuring Settings

6.1	Settings	6-2
6.2	General Settings 1/2.....	6-6
6.3	General Settings 2/2.....	6-21
6.4	Save Data Settings 1/2	6-46
6.5	Save Data Settings 2/2	6-62
6.6	Communication Settings	6-67
6.7	Voltage Quality Settings	6-72
6.8	Hardware Settings	6-76
6.9	Analog I/O Settings	6-88

6.1 Settings

Before making measurements, you need to set up the measurement conditions, data save, and other information beforehand.

● Screen Configuration

The Setup screen consists of the following screens:

SETUP 2004.06.23 11:39:21 Page 1/2

GENERAL	SAVE	COMMUN ▾
WIRING	: 3P3W2L	
LOAD	: LOAD1	
VOLTAGE	U13	
U RANGE	150V	
VT	0001.00	
CURRENT	CH13	
R RANGE	20A	
CT	0001.00	
CLAMP	96030	

← Tab
(Use the right and left cursor keys to switch)

- General (1/2, 2/2)
- Save (1/2, 2/2)
- Communication

SETUP 2004.06.23 11:39:22

VOLT. QUALITY	HARDWARE	ANAL ▾
VOLT. QUALITY MEAS.	: OFF	
STANDARD VOLTAGE	: 120V	

← Tab
(Use the right and left cursor keys to switch)

- Volt. Quality
- Hardware
- Analog I/O (optional)

⚠ NOTE

- Setting items (with the exception of some) cannot be changed during integration measurements (including when on standby).
- Unless integral measured data has been cleared, setting items (with the exception of some) cannot be changed. To change a setting item, press the F5 key (HOLD/Clear) for more than 3 seconds on the Measure screen to clear integral measured data and then change the setting.

● Setting Items

General		Save	
1/2	2/2	1/2	2/2
WIRING LOAD (1P CONNECT) U RANGE VT A RANGE CT CLAMP	VAR METHOD SAMPLING METHOD FREQUENCY SOURCE AVERAGE TIMES ZERO CROSS FILTER Wh DISPLAY Position of decimal point and unit of measurement INTERVAL Wh DISP. Position of decimal point and unit of measurement THD MEASURE METHOD PA CALC. METHOD HARM. GRAPH ORDER	MEASURE START/STOP SAVE INTER. (Interval time) DATA SAVE HARD COPY FILE NAME	Save/Not to save E.ENERGY/DEM. WAVEFORM DATA NORMAL MEAS. HARM. MEAS. HARM. MEAS. DETA. INST. AVE. MAX. MIN.

Communication	Volt. Quality	Hardware
RS-232 CONNECT BAUD RATE DATA LENGTH PARITY STOP BIT FLOW CONTROL	Measure/Not to measure STANDARD VOLTAGE Threshold value SWELL DIP INTERRUPTION HYSTERESIS	LANGUAGE BEEP BACKLIGHT AUTO OFF LCD CONTRAST ID NUMBER DATE AND TIME

For more information on the setting procedure of the following, see the chapters below:

General Settings 1/2	Section 6.2
General Settings 2/2	Section 6.3
Save Data Settings 1/2	Section 6.4
Save Data Settings 2/2	Section 6.5
Communication Settings	Section 6.6
Voltage Quality Settings	Section 6.7
Hardware Settings	Section 6.8
Analog I/O Settings	Section 6.9

6.1 Settings

● Displaying the Setup Screen

- 1 **Displaying the Top Menu screen**
 Press the TOP MENU key.
 The Top Menu screen appears.

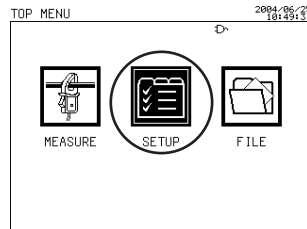

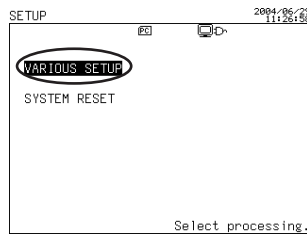

- 2 **Selecting a setting**
 Using the cursor keys, select a desired setting item.
 The selected item is highlighted.

- 3 **Displaying the Setup top screen.**
 Press the ENTER key to confirm it.
 The Setup top screen appears.



- 4 **Selecting various settings**
 Using the cursor keys, select the various settings.
 The selected item is highlighted.

-  Press the ENTER key to confirm it.
 The Setup screen appears.

- 5 **Selecting the Setup screen**
 Using the cursor keys, select a setup screen required.

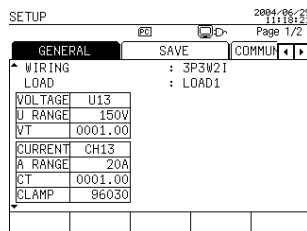

● **Selecting the Setup Screen**



To switch to another setup screen, use the cursor keys.

<1> Use the right and left cursor keys to switch a setup screen to another setup screen.

Example: General → Save

<2> Use the up and down cursor keys to move between pages of the same screen.

Example: General 1/2 → General 2/2

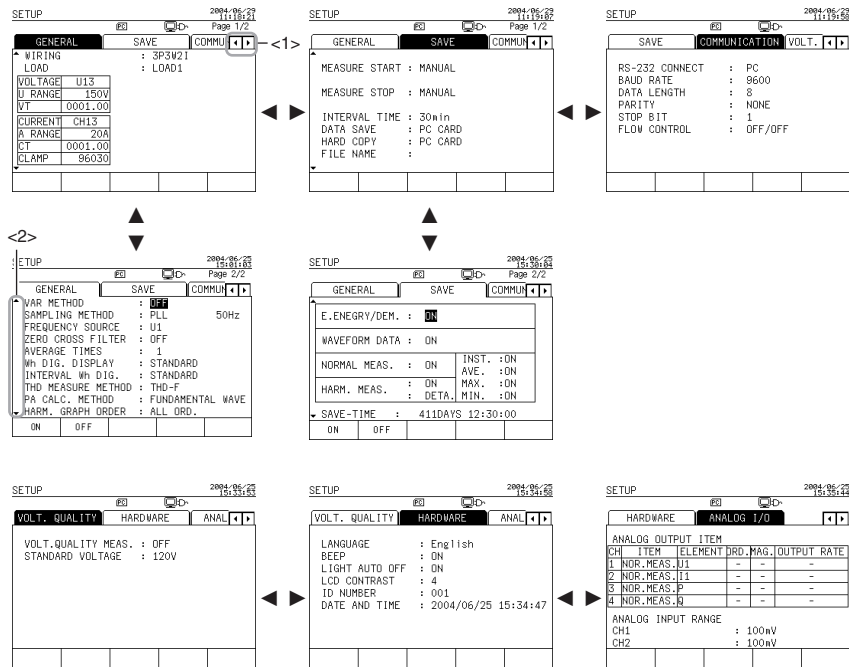

Exiting the Setup screen:

To the Top Menu screen:



Press the ENTER key while a setup screen is displayed.

The screen returns to the Top Menu screen.

6.2 General Settings 1/2

SETUP		2004.06.23 11:21:33
GENERAL		SAVE COMMUN
Wiring	WIRING	: 3P3W2I
Number of loads	LOAD	: LOAD1
Voltage (U) range	VOLTAGE	U13
VT ratio	U RANGE	150V
	VT	0001.00
Current (A) range	CURRENT	CH13
CT ratio	A RANGE	20A
	CT	0001.00
Clamp-on probe (model)	CLAMP	96030

NOTE

- Setting items cannot be changed during integration measurements (including when on standby).
 - Unless integral measured data has been cleared, setting items cannot be changed. To change a setting item, press the F5 key (HOLD/Clear) for more than 3 seconds on the Measure screen to clear integral measured data and then change the setting.
 - Settings cannot be changed under the following conditions:
 - The product of "rated power × VT ratio × CT ratio × 1.3" exceeds 999.9 TW.
 - Setting items: wiring, voltage range, current range, type of clamp-on probe, VT ratio, and CT ratio
- If a setting needs to be changed in the above condition, also change other settings so that the product is less than 999.9 TW.

6.2.1 Setting Up the Wiring (Wiring System)

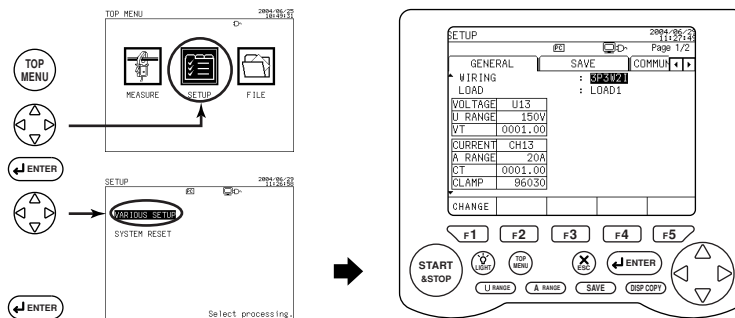

1 Displaying the General 1/2 screen



Using the right and left cursor keys, select the General tab (highlighted).

2 Changing Wiring



Using the up and down cursor keys, select WIRING (highlighted).

3 Displaying the window



Press the F1 key (CHANGE).

The window for selecting wiring appears.

3P3W+1P3W	Scott connection
3P4W4I	Three-phase four-wire four-current
3P4W	Three-phase four-wire
3P3W3I	Three-phase three-wire three-current
3P3W2I	Three-phase three-wire two-current
1P3W3I	Single-phase three-wire three-current
1P3W	Single-phase three-wire
1P2W	Single-phase two-wire

Default: 3P3W2I

4 Selecting wiring



Using the cursor keys, select a desired wiring (highlighted).

To cancel changing the setting, press the ESC key. The window returns to the General screen.

5 Confirmation



Press the ENTER key.

This closes the window, returning you to the General screen.
The selected wiring is displayed on the screen.

Ending setup:

To also change another setting	To return to the Top Menu
Select a desired setting using the cursor keys.	ENTER key

6.2 General Settings 1/2

6.2.2 Setting Up the Number of Loads

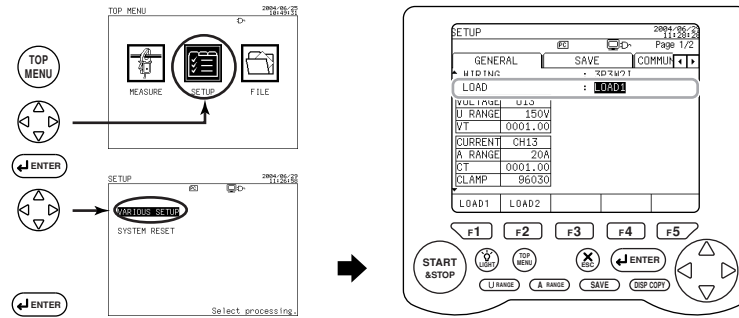

1 Displaying the General 1/2 screen



Using the right and left cursor keys, select the General tab (highlighted).

2 Changing the number of loads



Using the up and down cursor keys, select LOAD (highlighted).
The function key labels change.

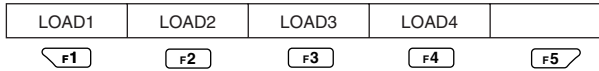

Default: LOAD1

3 Setup

F1 to F4 Press the corresponding function key to set the number of loads.

Ending setup:

To also change another setting	To return to the Top Menu
Select a desired setting using the cursor keys.	ENTER key

TIP

- The CW240 can measure multiple loads (systems) of the same power supply (voltage input shared).
- The number of loads to be selected varies depending on the setting of the wiring.

1P2W	LOAD1, LOAD2, LOAD3, LOAD4
1P3W 3P3W2I	LOAD1, LOAD2
1P3W3I 3P3W3I 3P4W 3P4W4I 3P3W+1P3W	LOAD1 only

6.2 General Settings 1/2

6.2.3 Setting Up 1P Connection (Scott Connection)

If wiring is set to 3P3W+1P3W (Scott connection), it is necessary to set up single-phase load connection (1P connection).

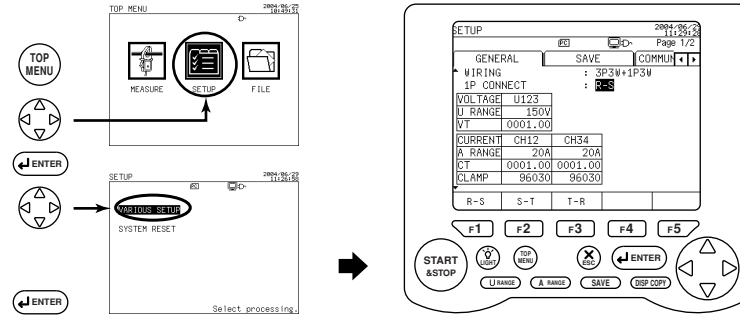

1 Displaying the General 1/2 screen



Using the right and left cursor keys, select the General tab (highlighted).

2 Changing 1P connection



Using the up and down cursor keys, select 1P CONNECT (highlighted).

The function key labels change.



Default: R-S

3 Setup

F1 to **F3** Press the corresponding function key to set 1P connection.

Ending setup:

To also change another setting	To return to the Top Menu
Select a desired setting using the cursor keys.	ENTER key

● **Scott Connection**

If wiring is set to 3P3W+1P3W (Scott connection), the setting of 1P connection is displayed (instead of the number of loads).

In Scott connection, it is necessary to set single phase-side connection (1P connection).

To check whether connection setting has been correctly made, view the Wiring Check screen.

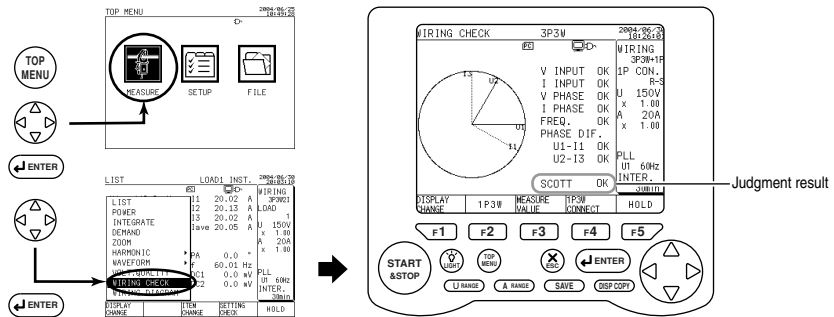

SEE ALSO

For more information, see Section 4.7, Checking Wiring.

6.2 General Settings 1/2

6.2.4 Setting Up the Voltage Range

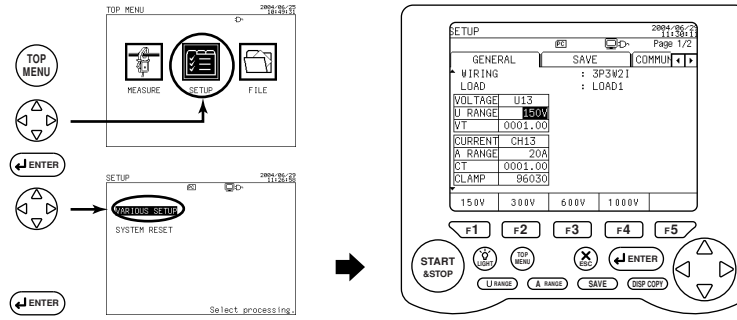

1 Displaying the General 1/2 screen



Using the up and down cursor keys, select the General tab (highlighted).

2 Changing the U range (voltage range)



Using the up and down cursor keys, select U RANGE (highlighted). The function key labels change.

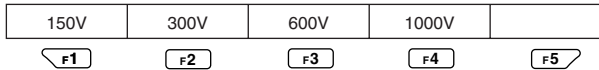

Default: 150 V

3 Setup

F1 to **F4** Press the corresponding function key to set the voltage range.

Ending setup:

To also change another setting	To return to the Top Menu
Select a desired setting using the cursor keys.	ENTER key

A voltage range can also be changed and set using the **U RANGE** key (**Direct key**) on the Measure screen.

SEE ALSO

For more information, see Section 5.1, Setting the Voltage Range, in Chapter 5, Setting Ranges Using the Direct Keys.

6.2.5 Setting Up the Current Range

The current range varies depending on the clamp-on probe to be used. See 6.2.6, Setting Up a Clamp-on Probe.

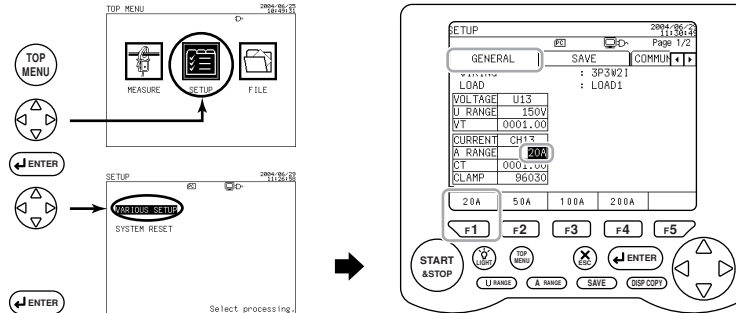

1 Displaying the General 1/2 screen



Using the right and left cursor keys, select the General tab (highlighted).

2 Changing the A range (current range)



Using the up and down cursor keys, select A RANGE (highlighted). The function key labels change.

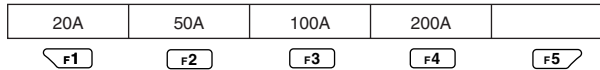

Default: 20 A (with clamp-on probe 96030 set up)

The default shows the minimum range of each clamp-on probe.

3 Setup

F1 to **F4** Press the corresponding function key to set the current range.

Ending setup:

To also change another setting	To return to the Top Menu
Select a desired setting using the cursor keys.	ENTER key

A current range can also be changed and set using the **A RANGE** key (**Direct key**) on the Measure screen.

SEE ALSO

For more information, see Section 5.2, Setting the Current Range, in Chapter 5, Setting Ranges Using the Direct Keys.

6.2 General Settings 1/2

6.2.6 Setting Up a Clamp-on Probe

Set the model of a clamp-on probe to be connected to the CW240.

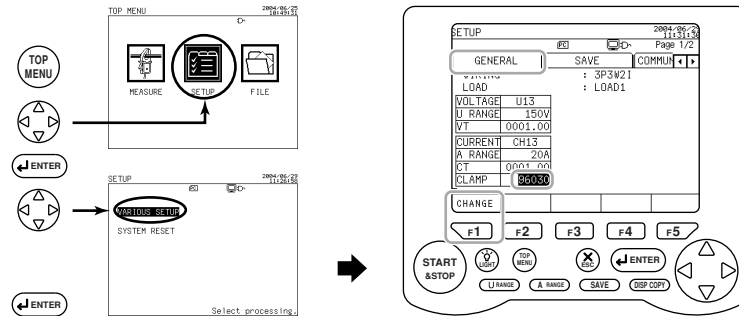

1 Displaying the General 1/2 screen



Using the right and left cursor keys, select the General tab (highlighted).

2 Changing a clamp-on probe

Using the up and down cursor keys, select **CLAMP** (highlighted).
The function key labels change.

3 Displaying the window

Press the **F1** key (**CHANGE**).

The window for selecting a clamp-on probe appears.

```
96035_2
96035_1
96034_3
96034_2
96034_1
96032
96031
96030
96033
96036
```

Default: 96030

4 Selecting a clamp-on probe

Using the cursor keys, select the model of a clamp-on probe
(highlighted).

To cancel changing the setting, press the ESC key. The window returns to the General screen.

5 Confirmation

Press the **ENTER** key.

This closes the window, returning you to the General screen. The selected clamp-on current probe is displayed on the screen.

Ending setup:

To also change another setting	To return to the Top Menu
Select a desired setting using the cursor keys.	ENTER key

6.2 General Settings 1/2

● Types of Clamp-on Probes and Current Ranges

Model of Clamp-on Probes	Function Keys			
	F1	F2	F3	F4
96036	200mA	500mA	1A	2A
96033	5A	10A	20A	50A
96030	20A	50A	100A	200A
96031	50A	100A	200A	500A
96032	200A	500A	1000A	
96034_1	300A	750A	1500A	3000A
96034_2	200A	500A	1000A	2000A
96034_3	100A	200A	500A	1000A
96035_1	300A	750A	1500A	3000A
96035_2	30A	75A	150A	300A

96034 or 96035: The current range is selected using the switch on a clamp-on current probe.

SEE ALSO

For the specifications of clamp-on probes, see Section 17.2, Specifications of Current Clamps (Clamp-on Probes). A clamp-on probe is also provided with the User's Manual.

● For Connecting Different Types of Clamp-on Current Probes

- If LOAD is set to multiple loads (LOAD2, LOAD3, or LOAD4), a different clamp-on probe can be set for each load.
- If WIRING is set to 1P3W3I or 3P4W4I, a clamp-on probe can be separately set for I4.
- If WIRING is set to Scott Connection (3P3W + 1P3W), a clamp-on probe can be separately set for the three-phase (3P3W) and single-phase (1P3W) sides.

6.2.7 Setting Up VT and CT Ratios

● Setting Up a VT Ratio

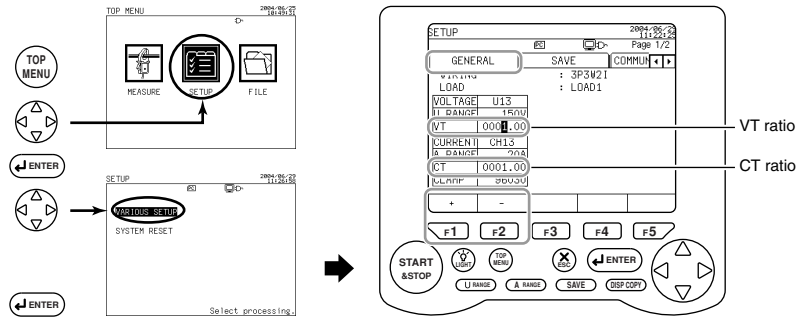

1 Displaying the General 1/2 screen



Using the right and left cursor keys, select the General tab (highlighted).

2 Changing a VT ratio



Using the up and down cursor keys, select VT (highlighted).
The function key labels change.



Default: 1.00

3 Selecting a digit



Using the right and left cursor keys, select the digit (highlighted) in which you wish to change a value.

4 Setup

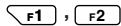

Press the corresponding function key to increment/decrement a value.

F1: + Increments a value.

F2: - Decrements a value.

6.2 General Settings 1/2

● Setting Up a CT Ratio

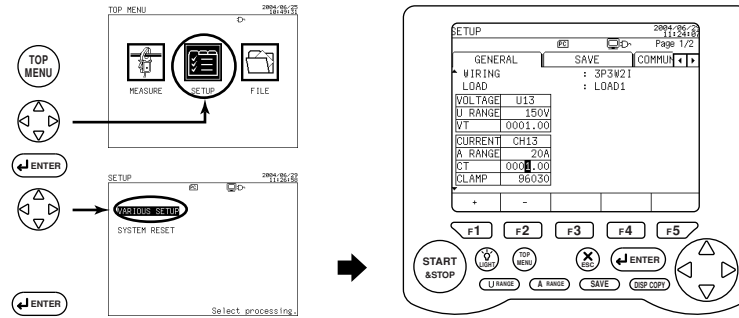

1 Displaying the General 1/2 screen



Using the right and left cursor keys, select the General tab (highlighted).

2 Changing a CT ratio



Using the up and down cursor keys, select CT (highlighted).

The function key labels change.

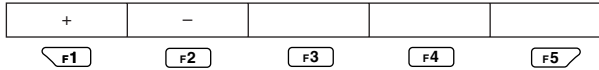

Default: 1.00

3 Selecting a digit



Using the right and left cursor keys, select the digit (highlighted) in which you wish to change a value.

4 Setup

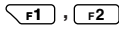

Press the corresponding function key to increment/decrement a value.

F1: + Increments a value.

F2: - Decrements a value.

Ending setup:

To also change another setting	To return to the Top Menu
Select a desired setting using the cursor keys.	ENTER key

6.2 General Settings 1/2

● VT Ratio and CT Ratio

A VT ratio and CT ratio are set up when you use a VT (voltage transformer) and/or CT (current transformer) to measure the circuit under test on the secondary winding of the VT and/or CT.

Setting up the VT and/or CT ratio allows voltage and current values to be applied to the primary winding.

● Indication Provided if VT and CT Are Used

If VT and CT are used (VT and CT ratios set up to conduct measurements), the measured values are indicated as follows:

Voltage range: voltage range \times VT ratio

Current range: current range \times CT ratio

Power: rated power \times VT ratio \times CT ratio

● Examples of Calculating the VT and CT Ratios

VT ratio:

If VT of 2200 V on the primary winding and 110 V on the secondary winding are used, the VT ratio becomes 20:1. (Set the VT ratio to 20.00.)

CT ratio:

If CT of 100 A on the primary winding and 5 A on the secondary winding are used, the CT ratio becomes 20:1. (Set the CT ratio to 20.00.)

● For Setting Up Different CT Ratios

- If LOAD is set to multiple loads (LOAD2, LOAD3, or LOAD4), a CT ratio can be set for each load.
- If WIRING is set to 1P3W3I or 3P4W4I, a CT ratio for I4 can be separately set.
- If WIRING is set to Scott connection (3P3W+1P3W), a CT ratio can be separately set for the three-phase (3P3W) and single-phase (1P3W) sides.

NOTE

-
- The setting range of the VT and CT ratios is from 0.01 to 9999.99 (default: 1.00).
 - Settings cannot be under the following conditions:
The product of “rated power \times VT ratio \times CT ratio \times 1.3” exceeds 999.9 TW.
-

SEE ALSO

For connection of VT and/or CT, see Section 4.6, Wiring the Measurement Circuit Using External VT/CT.

6.3 General Settings 2/2

The General 2/2 screen allows you to set up the following items:

Setting Item	Description
VAR METHOD	Sets whether to use a reactive power meter method.
SAMPLING METHOD	Sets PLL synchronization or fixed clock (50/60 Hz).
FREQUENCY SOURCE	Sets a voltage input level regarded as the reference for frequency measurement.
AVERAGE TIMES	Performs moving averaging of measured data. (Sets the number of averaging times.)
ZERO CROSS FILTER	Sets whether to insert a zero cross filter into the frequency circuit.
Wh DISPLAY	Sets the number of digits that can be displayed and the unit of measurement of electric energy in integration measurements.
INTERVAL Wh DISP.	Sets the number of digits that can be displayed and the unit of measurement of interval electric energy in demand measurements.
THD MEASURE METHOD	Sets the calculation method of total harmonics distortion (THD).
PA CALC. METHOD	Sets the reference for harmonic phase angle.
HARM. GRAPH ORDER	Sets the order (all orders/odd-number orders) of harmonics to be displayed on a graph.

Setting Item	Description
VAR METHOD	Sets whether to use a reactive power meter method.
SAMPLING METHOD	Sets PLL synchronization or fixed clock (50/60 Hz).
FREQUENCY SOURCE	Sets a voltage input level regarded as the reference for frequency measurement.
AVERAGE TIMES	Performs moving averaging of measured data. (Sets the number of averaging times.)
ZERO CROSS FILTER	Sets whether to insert a zero cross filter into the frequency circuit.
Wh DISPLAY	Sets the number of digits that can be displayed and the unit of measurement of electric energy in integration measurements.
INTERVAL Wh DISP.	Sets the number of digits that can be displayed and the unit of measurement of interval electric energy in demand measurements.
THD MEASURE METHOD	Sets the calculation method of total harmonics distortion (THD).
PA CALC. METHOD	Sets the reference for harmonic phase angle.
HARM. GRAPH ORDER	Sets the order (all orders/odd-number orders) of harmonics to be displayed on a graph.

For the setting up of zero cross filter, see Section 6.8.5, Setting Up ON/OFF of a Zero Cross Filter.

NOTE

- Setting items cannot be changed during integration measurements (including when on standby).
- Unless integral measured data has been cleared, setting items cannot be changed (with the exception of HARM. GRAPH ORDER). To change a setting item, press the F5 key (HOLD/Clear) for more than 3 seconds on the Measure screen to clear integral measured data and then change the setting.

6.3 General Settings 2/2

6.3.1 Setting Up a Reactive Power Meter Method

The CW240 allows you to select whether to use a reactive power meter method when calculating reactive energy.

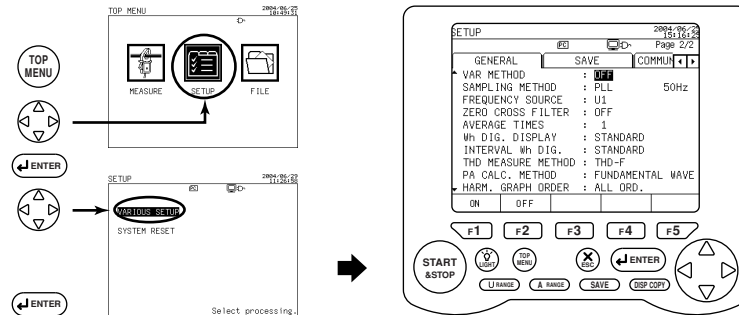

1 Displaying the General 1/2 screen



Using the right and left cursor keys, select the General tab (highlighted).

2 Displaying the General 2/2 screen



Using the up and down cursor keys, display the General 2/2 screen.

3 Changing a reactive power meter method



Using the up and down cursor keys, select VAR METHOD (highlighted).

The function key labels change.



Default: OFF

4 Setup

F1 , **F2** Press the corresponding function key to set whether to use the reactive power meter method.

F1: ON Uses the reactive power meter method.

F2: OFF Disables use of the reactive power meter method.

Ending setup:

To also change another setting	To return to the Top Menu
Select a desired setting using the cursor keys.	ENTER key

SEE ALSO

For more information on the reactive power meter method, see Appendix 5, Reactive Power Method.

6.3 General Settings 2/2

6.3.2 Setting Up the Sampling Method

You can select either of the following sampling methods.

PLL synchronization method: PLL (50/60 Hz)

Fixed clock: FIX (50/60 Hz)

● PLL Synchronization

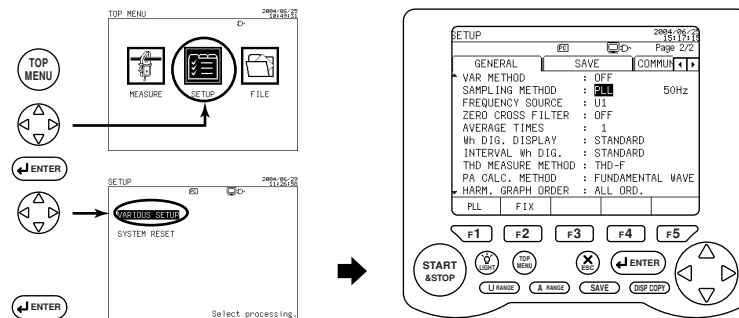

1 Displaying the General 1/2 screen



Using the right and left cursor keys, select the General tab (highlighted).

2 Displaying the General 2/2 screen



Using the up and down cursor keys, display the General 2/2 screen.

3 Changing the sampling method



Using the up and down cursor keys, select SAMPLING METHOD (highlighted).

The function key labels change.



Default: PLL

4 Setup

F1 , **F2** Press the corresponding function key to set the sampling method.
F1: PLL synchronization
F2: Fixed clock

Ending setup:

To also change another setting	To return to the Top Menu
Select a desired setting using the cursor keys.	ENTER key

SEE ALSO

For more information on the sampling method, see Appendix 6, Sampling Method.

6.3 General Settings 2/2

● Fixed Clock

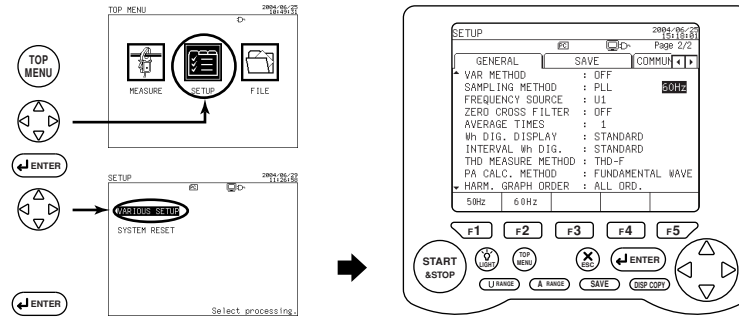

1 Displaying the General 1/2 screen



Using the right and left cursor keys, select the General tab (highlighted).

2 Displaying the General 2/2 screen



Using the up and down cursor keys, display the General 2/2 screen.

3 Selecting the frequency





Using the cursor keys, select frequency indication (highlighted).
The function key labels change.



Default: 50 Hz

4 Setup

 ,  Press the corresponding function key to select the desired frequency.
 F1: 50 Hz
 F2: 60 Hz

Ending setup:

To also change another setting	To return to the Top Menu
Select a desired setting using the cursor keys.	ENTER key

 **NOTE**
PLL Unlock

When the sampling method has been set to PLL, if a condition arises in which the PLL source is unavailable, the CW240 switches to the fixed clock selected here to continue measurements.

For more information, see Appendix 6, Sampling Method.

6.3 General Settings 2/2

6.3.3 Setting Up the Frequency Source

Set a voltage input to be used as the reference for frequency measurement.

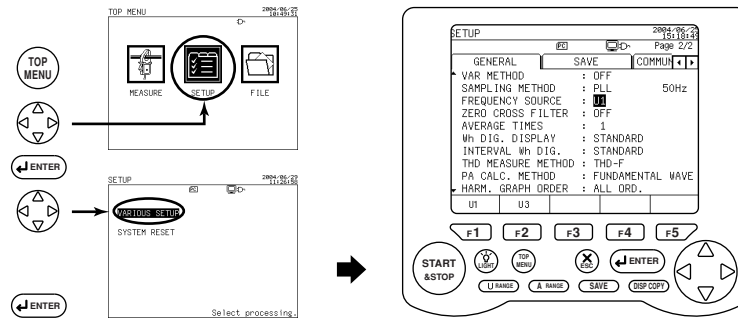

1 Displaying the General 1/2 screen



Using the right and left cursor keys, select the General tab (highlighted).

2 Displaying the General 2/2 screen



Using the up and down cursor keys, display the General 2/2 screen.

3 Changing the frequency source



Using the up and down cursor keys, select FREQUENCY SOURCE (highlighted).

The function key labels change.

U1	U2	U3		
F1	F2	F3	F4	F5

Default: U1

4 Setup

F1 to **F3** Press the corresponding function key to set the desired frequency source.

Ending setup:

To also change another setting	To return to the Top Menu
Select a desired setting using the cursor keys.	ENTER key

TIP

- The function display labels (U1, U2, U3) change depending on the setting of the wiring.
- If the phase angle calculation method is set to a U1-base method, the frequency source is limited to U1.

6.3 General Settings 2/2

6.3.4 Setting Up the Display Averaging Times

If the reading drifts and is difficult to read due to significant variations of a measurement line, moving averaging is performed. This section explains how to set the number of averaging times.

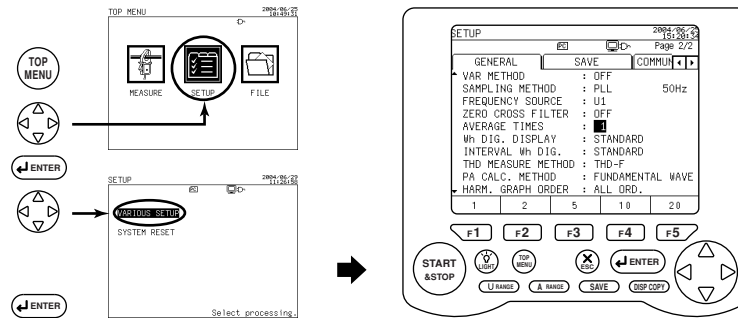

1 Displaying the General 1/2 screen



Using the right and left cursor keys, select the General tab (highlighted).

2 Displaying the General 2/2 screen



Using the up and down cursor keys, display the General 2/2 screen.

3 Changing the display averaging times



Using the up and down cursor keys, select AVERAGE TIMES (highlighted).

The function key labels change.

1	2	5	10	20
---	---	---	----	----

F1

F2

F3

F4

F5

Default: 1

4 Setup

F1 to **F5** Press the corresponding function key to set a desired number of averaging times.

Ending setup:

To also change another setting	To return to the Top Menu
Select a desired setting using the cursor keys.	ENTER key

● **Moving Averaging Equation**

Display value = $(M_n - (m - 1) + \dots + M_{n-2} + M_{n-1} + M_n) / m$

where

m : number of averaging times to be set

(selected from among 1, 2, 5, 10, and 20)

M_n : n-th measured value

6.3 General Settings 2/2

6.3.5 Setting Up the Electric Energy Indication

For electric energy indication, you can set up the position of the decimal point and the unit of measurement.

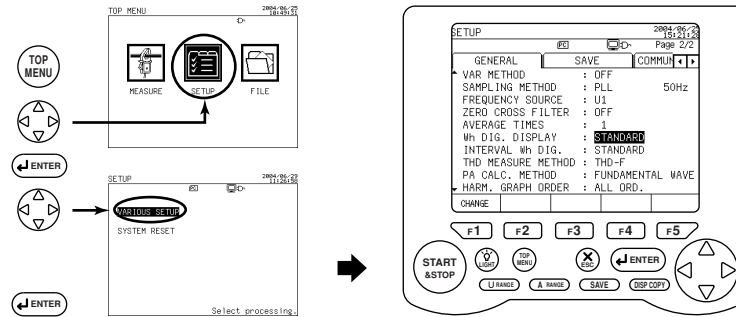

1 Displaying the General 1/2 screen



Using the right and left cursor keys, select the General tab (highlighted).

2 Displaying the General 2/2 screen



Using the up and down cursor keys, display the General 2/2 screen.

● When Changing the Setting

3 Changing electric energy indication



Using the up and down cursor keys, select Wh DISPLAY (highlighted).

The function key labels change.



4 Displaying the window



Press the F1 key (CHANGE).

The window for selecting the position of the decimal point appears.

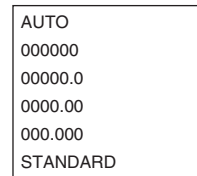

Default: STANDARD

5 Selecting the position of the decimal point



Using the cursor keys, select the desired position of the decimal point (highlighted).

To cancel changing the setting, press the ESC key. The window returns to the General screen.

6 Confirmation



Press the ENTER key.

This closes the window, returning you to the General screen.

If you selected any option other than STANDARD or AUTO, see the setting procedure described on the next page to change the unit of electric energy.

To also change another setting	To return to the Top Menu
Select a desired setting using the cursor keys.	ENTER key

6.3 General Settings 2/2

● Setting the Unit of Measurement

If electric energy indication is set to any option other than STANDARD or AUTO (that fixes the position of the decimal point), the unit of measurement needs to be set.

After setting the position of the decimal point, set the unit of measurement.

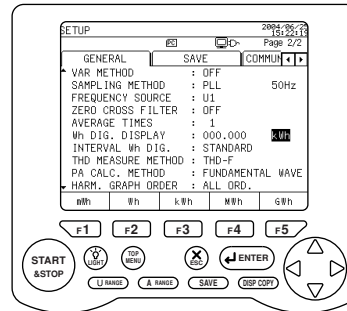

1 Changing the unit of measurement



Using the right and left cursor keys, select UNIT (highlighted).

The function key labels change.

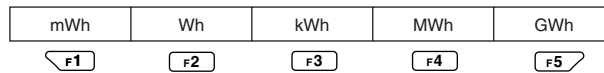

Default: kWh

2 Setup

F1 to **F5** Press the corresponding function key to select the desired unit.

Ending setup:

To also change another setting	To return to the Top Menu
Select a desired setting using the cursor keys.	ENTER key

● **Determining the Position of the Decimal Point and the Unit of Measurement Automatically**

The position of the decimal point and the unit of measurement are automatically determined from the product of "rated power × VT ratio × CT ratio."

STANDARD, AUTO

SEE ALSO

For more information on STANDARD or AUTO, see Section 5.3, Ranges and Number of Digits.

● **Setting the Position of the Decimal Point**

The number of digits for electric energy indication is 6 digits.

The position of the decimal point can be fixed.

000.000 / 0000.00 / 00000.0 / 000000

In this case, the unit of electric energy needs to be set.

● **Setting the Unit of Measurement**

When the position of the decimal point is fixed, select the unit of electric energy from among the following:

mWh / Wh / kWh / MWh / GWh

TIP

The number of digits and the unit of measurement to be displayed for regenerative energy, lagging reactive energy, and leading reactive energy are also set up in the same way.

6.3 General Settings 2/2

6.3.6 Setting Up the Interval Electric Energy Indication

"Interval electric energy indication" means an item for setting up the position of the decimal point and unit of measurement for electric energy within interval time in demand measurements.

The setting procedure is the same as that of electric energy indication (6.3.5, Setting Up the Electric Energy Indication).

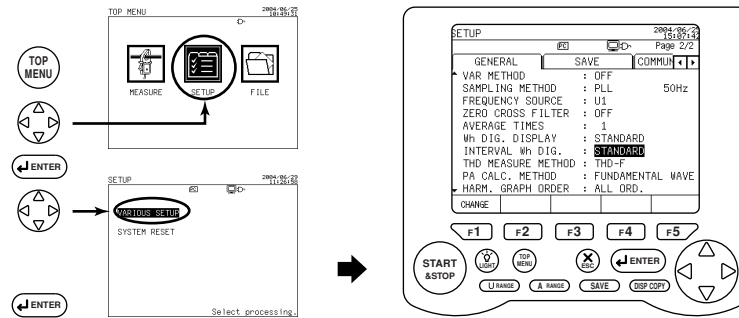

1 Displaying the General 1/2 screen



Using the right and left cursor keys, select the General tab (highlighted).

2 Displaying the General 2/2 screen



Using the up and down cursor keys, display the General 2/2 screen.

● When Changing the Setting

3 Changing interval electric energy indication



Using the up and down cursor keys, select INTERVAL Wh DISP. (highlighted).

The function key labels change.

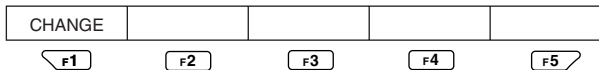

4 Displaying the window



Press the F1 key (CHANGE).

The window for selecting the position of the decimal point appears.

- AUTO
- 000000
- 00000.0
- 0000.00
- 000.000
- STANDARD

Default: STANDARD

5 Selecting the position of the decimal point



Using the cursor keys, select the desired position of the decimal point (highlighted).

To cancel changing the setting, press the ESC key. The window returns to the General screen.

6 Confirmation



Press the ENTER key.

This closes the window, returning you to the General screen.

Ending setup:

If you selected any option other than STANDARD or AUTO, see the setting procedure described on the next page to change the unit of electric energy.

To also change another setting	To return to the Top Menu
Select a desired setting using the cursor keys.	ENTER key

6.3 General Settings 2/2

● For Setting the Unit of Measurement

If interval electric energy indication is set to any option other than STANDARD or AUTO (which fixes the position of the decimal point), the unit of measurement needs to be set.

After setting the position of the decimal point, set the unit of measurement.

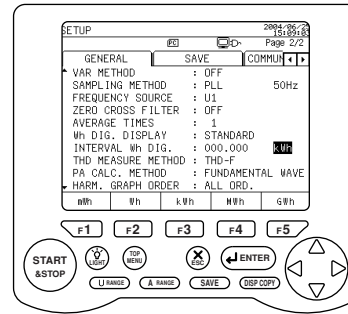

1 Changing the unit of measurement



Using the right and left cursor keys, select UNIT (highlighted).

The function key labels change.

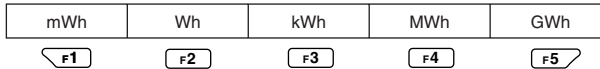

Default: kWh

2 Setup

F1 to **F5** Press the corresponding function key to select the desired unit.

Ending setup:

To also change another setting	To return to the Top Menu
Select a desired setting using the cursor keys.	ENTER key

● **Determining the Position of the Decimal Point and the Unit of Measurement Automatically**

The position of the decimal point and the unit of measurement are automatically determined from the product of "rated power × VT ratio × CT ratio."
STANDARD, AUTO

SEE ALSO

For more information on STANDARD or AUTO, see Section 5.3, Ranges and Number of Digits.

● **Setting the Position of the Decimal Point**

The number of digits for electric energy indication is 6 digits.

The position of the decimal point can be fixed.

000.000 / 0000.00 / 00000.0 / 000000

In this case, the unit of electric energy needs to be set.

● **Setting the Unit of Measurement**

When the position of the decimal point is fixed, select the unit of electric energy from among the following:

mWh / Wh / kWh / MWh / GWh

TIP

The number of digits and the unit of measurement to be displayed for regenerative energy, lagging reactive energy, and leading reactive energy are also set up in the same way.

6.3 General Settings 2/2

6.3.7 Setting Up the THD Measuring Method

THD stands for Total Harmonic Distortion.

There are two types of total harmonic distortion calculation method, either of which can be selected.

1. With reference to fundamental wave (THD-F)
2. With reference to total rms values (THD-R)

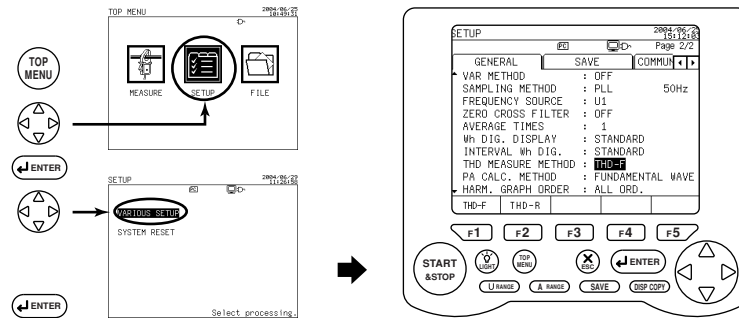

1 Displaying the General 1/2 screen



Using the right and left cursor keys, select the General tab (highlighted).

2 Displaying the General 2/2 screen



Using the up and down cursor keys, display the General 2/2 screen.

3 Changing the reference



Using the up and down cursor keys, select THD MEASURE METHOD (highlighted).

The function key labels change.

THD-F	THD-R			
F1	F2	F3	F4	F5

Default: THD-F

4 Setup

F1 , **F2** Press the corresponding function key to set the reference.
F1: THD-F, fundamental waves
F2: THD-R, total rms values

Ending setup:

To also change another setting	To return to the Top Menu
Select a desired setting using the cursor keys.	ENTER key

SEE ALSO

For details of the calculation, see the basic equation for harmonic measurements in Chapter 17, CW 240 Specifications.

6.3 General Settings 2/2

6.3.8 Setting Up a Phase Angle Calculation Method

There are two types of reference for harmonic phase angle:

1. With reference to fundamental wave
2. With reference to voltage input (U1)

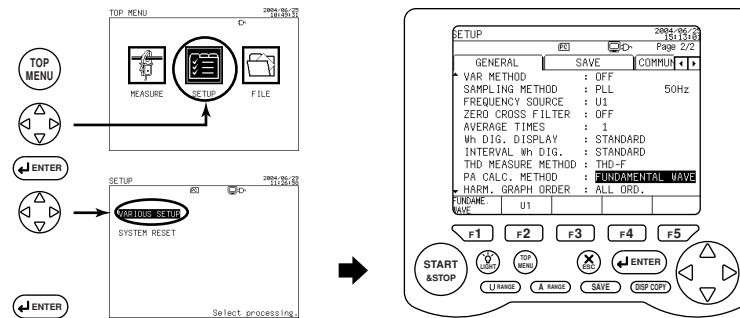

1 Displaying the General 1/2 screen



Using the right and left cursor keys, select the General tab (highlighted).

2 Displaying the General 2/2 screen



Using the up and down cursor keys, display the General 2/2 screen.

3 Changing the reference



Using the up and down cursor keys, select PA CALC. METHOD (highlighted).

The function key labels change.

FUNDME. WAVE	U1			
F1	F2	F3	F4	F5

Default: FUNDME. WAVE

4 Setup

 ,  Press the corresponding function key to set the reference.

F1: With reference to fundamental wave

F2: With reference to U1 (voltage input)

Ending setup:

To also change another setting	To return to the Top Menu
Select a desired setting using the cursor keys.	ENTER key

SEE ALSO

For details of the calculation, see the basic equation for harmonic measurements in Chapter 17, CW 240 Specifications.

 **NOTE**

When the phase angle calculation method is set to U1 base, the frequency source is automatically set to U1.

6.3 General Settings 2/2

6.3.9 Setting Up the Harmonic Graph Display Order

In harmonic measurement, 1st to 50th harmonics are analyzed. The results of measurement are displayed in a list (table), graph, or vector diagram. For a graph, you can set up the order of harmonics to be displayed.

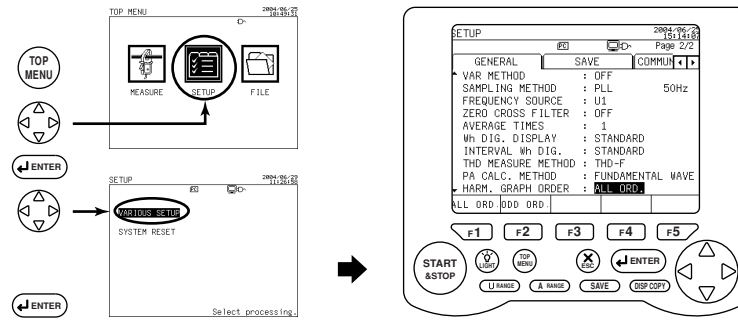

1 Displaying the General 1/2 screen



Using the right and left cursor keys, select the General tab (highlighted).

2 Displaying the General 2/2 screen



Using the up and down cursor keys, display the General 2/2 screen.

3 Changing the order





Using the up and down cursor keys, select HARM. GRAPH ORDER (highlighted).

The function key labels change.



Default: ALL ORD.

4 Setup

 ,  Press the corresponding function key to set the graph display order.
F1: All orders of 1st to 50th
F2: Odd-numbered orders only

Ending setup:

To also change another setting	To return to the Top Menu
Select a desired setting using the cursor keys.	ENTER key

6.4 Save Data Settings 1/2

The Save 1/2 screen allows you to set up the following items.

```

SETUP                                     2004.08.22
                                           11:38:22
                                           Page 1/2
-----
GENERAL  SAVE  COMMUN  ◀▶
-----
MEASURE START : MANUAL
MEASURE STOP  : MANUAL
INTERVAL TIME : 30min
DATA SAVE     : PC CARD
HARD COPY    : PC CARD
FILE NAME     :
    
```

Setting Item	Description
MEASURE START	Integration start time MANUAL/TIME/JUST
Integration start time	When TIME is selected, you can set the integration start time.
MEASURE STOP	Sets the integration stop method. MANUAL/TIME/TIMER
Integration stop time	When TIME is selected, you can set the integration stop time.
INTERVAL TIME	Sets data save (output) time. For demand measurement, demand interval is set.
DATA SAVE	Sets the device to which measured data is saved. PC CARD/MEMORY
HARD COPY	Sets the device to which a display screen is hard copied. PC CARD/MEMORY/PRINTER
FILE NAME	Used to enter a file name under which data is saved.



NOTE

- Setting items cannot be changed during integration measurements (including when on standby).
- Unless integral measured data has been cleared, the interval time and file name cannot be changed. To change a setting item, press the F5 key (HOLD/Clear) for more than 3 seconds on the Measure screen to clear integral measured data and then change the setting.

6.4.1 Setting Up the Integration Start Method

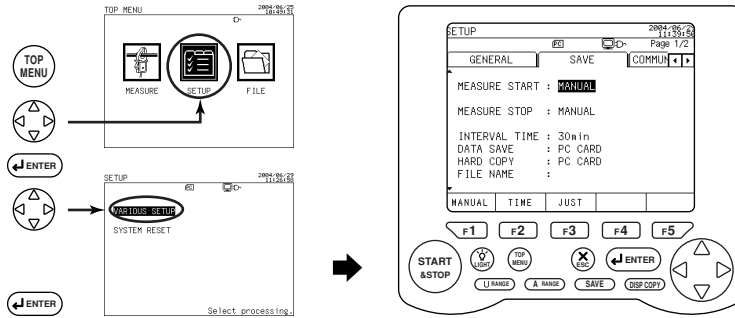

1 **Displaying the General 1/2 screen**
 Using the right and left cursor keys, select the Save tab (highlighted).



2 **Changing the integration start method**
 Using the up and down cursor keys, select MEASURE START (highlighted).
 The function key labels change.



Default: MANUAL

3 **Setup**
 Press the corresponding function key to set the integration start method.
 F1: Starts integration when the START&STOP key is pressed.
 F2: Sets the integration start time. (Integration starts at the set time.)
 F3: Starts integration at the optimum time when the START&STOP key is pressed. (The start time is calculated based on the interval time.)

Ending setup:

To also change another setting	To return to the Top Menu
Select a desired setting using the cursor keys.	ENTER key

6.4 Save Data Settings 1/2

● JUST

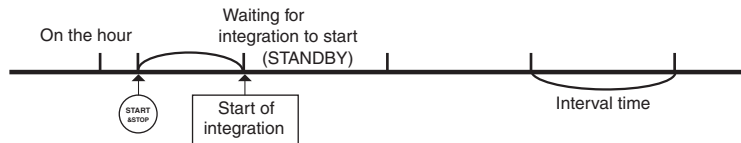

● Setting the Start Time

After selecting the time in the integration start method, enter the start time.

SETUP 2004/06/29
11:40:56
Page 1/2

GENERAL	SAVE	COMMUN	←	→
MEASURE START : TIME				
MEASURE STOP : MANUAL				
INTERVAL TIME : 30min				
DATA SAVE : PC CARD				
HARD COPY : PC CARD				
FILE NAME :				
+				

1 Changing the time



Using the cursor keys, select DATE AND TIME (highlighted).

The function key labels change.

+	-			
F1	F2	F3	F4	F5

2 Selecting items



Using the right and left cursor keys, select a desired item (highlighted).

Year / Month / Day / Hour / Minute

3 Setup



Press the corresponding function key to set the integration start time.

F1: + Increments a value.

F2: - Decrements a value.

Repeat steps **2** and **3** to set year/month/day/hour/minute data.

Ending setup:

To also change another setting	To return to the Top Menu
Select a desired setting using the cursor keys.	ENTER key

 **NOTE**

- The setting range of the integration start time is 0 hour 0 minute on Jan. 1, 2000 to 23 hours 59 minutes on Dec. 31, 2099.
 - If the current time has already passed the set integration start time when the START&STOP key is pressed, the CW240 starts integration measurement by JUST start.
 - Setting items cannot be changed during integration measurements (including when on standby).
-

6.4 Save Data Settings 1/2

6.4.2 Setting Up the Integration Stop Method

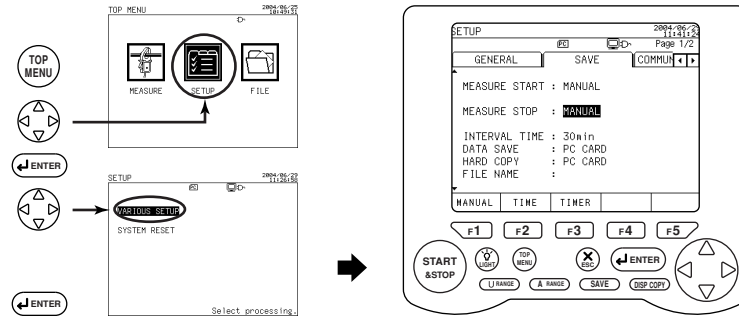

1 Displaying the Save 1/2 screen



Using the right and left cursor keys, select the Save tab (highlighted).

2 Changing the integration stop method



Using the up and down cursor keys, select MEASURE STOP (highlighted).

The function key labels change.



Default: MANUAL

3 Setup

F1 to **F3** Press the corresponding function key to set the integration stop method.

F1: Stops integration if the START&STOP key is pressed during integral measurement.

F2: Sets the integration stop time. (Integration stops at the set time.)

F3: Stops integration when the set time elapses.

Ending setup:

To also change another setting	To return to the Top Menu
Select a desired setting using the cursor keys.	ENTER key

● **Setting Up the Stop Time**

After selecting the time in the integration stop method, enter the integration stop time.

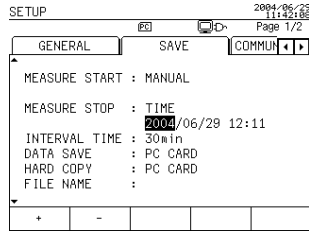

1 Changing the time



Using the cursor keys, select **DATE AND TIME** (highlighted).

The function key labels change.



2 Selecting items



Using the right and left cursor keys, select a desired item (highlighted).

Year / Month / Day / Hour / Minute

3 Setup



Press the corresponding function key to the integration stop time.

F1: + Increments a value.

F2: - Decrements a value.

Repeat steps **2** and **3** to set year/month/day/hour/minute data.

Ending setup:

To also change another setting	To return to the Top Menu
Select a desired setting using the cursor keys.	ENTER key

6.4 Save Data Settings 1/2

● If the Timer is Set

After selecting the timer in the integration stop method, enter the time.

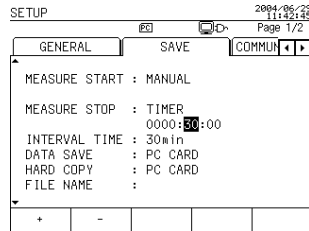

1 Changing the time



Using the cursor keys, select **TIME** (highlighted).

The function key labels change.



2 Selecting items



Using the right and left cursor keys, select a desired item (highlighted).

(Set Hour* on a digit basis.)

Hour* / Minute / Second

3 Setup

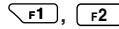

Press the corresponding function key to set the time.

F1: + Increments a value.

F2: - Decrements a value.

For the timer, time can be set in the range of 1 second (0000:00:01) to 8784 hours (8784:00:00).

Ending setup:

To also change another setting	To return to the Top Menu
Select a desired setting using the cursor keys.	ENTER key

6.4.3 Precautions for Selecting the Interval Time

Short-time Interval	Standard Interval	
1 wave	1sec	1min
100ms	2sec	2min
200ms	5sec	5min
500ms	10sec	10min
	15sec	15min
	30sec	30min
		60min

When making demand measurement, note the following:

- A demand interval of demand measurements is common to the interval time. If the interval time is set to a value less than short-time interval (less than 1 sec.), the demand measured value cannot be displayed (the symbol "----" appears).

When saving (outputting) data with the interval time set to 2 min or less, note the following:

- There may be cases where data is missed at the start depending on the number of files or space in a PC card. Set up the starting date and time with allowances.
- As the number of data increases, there are cases where data is missed in saved data.
- When using the CW240, especially when a short-time interval is set, note the following:
 - Ensure there is no file in the PC card. (Format the PC card.)
 - Start integration with a PC card inserted in the CW240.
 - Do not remove the PC card from the CW240 during integral measurement.
 - Do not perform communication.
 - Do not operate the operation keys excessively.

If the interval time is set to 30 sec or less, note the following:

- If RS-232 CONNECT has been set to PRINTER, change the setting to PC. (The $\text{\textcircled{M}}$ mark appears.)
- If HARD COPY has been set to PRINTER, change the setting to PC card.
- Note that automatic output of harmonic measured data or waveform data, or automatic printout of it to a printer, is not possible.

If the interval time is set to a short-time interval, note the following:

- For interval time-basis outputs during integration measurement, only instantaneous values of the normal measurement data are output.
- Files are generally created in a binary format. If a file is to be read by spreadsheet software, etc., conversion to a text file is required. (For conversion software, see the CD-ROM provided for the CW240.)

6.4 Save Data Settings 1/2

6.4.4 Setting Up the Interval Time

The interval time needs to be set up as data save (output) time or demand interval of demand measurements.

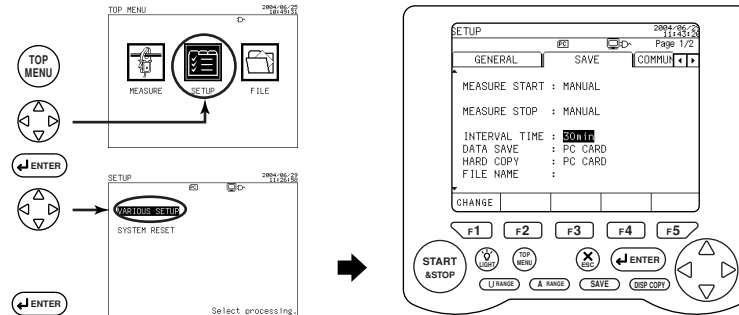

1 Displaying the Save 1/2 screen

Using the right and left cursor keys, select the Save tab (highlighted).



2 Changing the interval time

Using the up and down cursor keys, select INTERVAL TIME (highlighted).



3 Displaying the window



Press the F1 key (CHANGE).

The window for selecting the interval time appears.

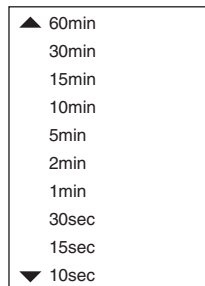

4 Selecting the interval time



Using the cursor keys, select the interval time (highlighted).

To cancel changing the setting, press the ESC key. The window returns to the Save screen.

5 Confirmation



Press the ENTER key.

This closes the window, returning you to the Save screen.

Ending setup:

To also change another setting	To return to the Top Menu
Select a desired setting using the cursor keys.	ENTER key

6.4 Save Data Settings 1/2

6.4.5 Setting Up the Data Saving Destination

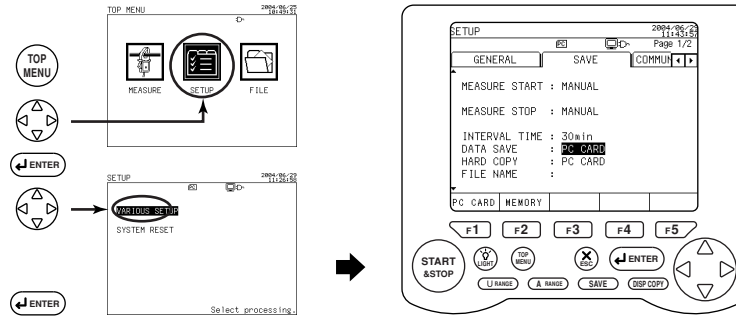

1 Displaying the Save 1/2 screen

Using the right and left cursor keys, select the Save tab (highlighted).



2 Changing the saving destination

Using the up and down cursor keys, select DATA SAVE (highlighted).

The function key labels change.



3 Setup

F1, **F2** Press the corresponding function key to set the data saving destination.

F1: Save to the PC card

F2: Save to the internal memory

Ending setup:

To also change another setting	To return to the Top Menu
Select a desired setting using the cursor keys.	ENTER key

TIP

Setting of measured data (items) to be saved is made on the Save 2/2 screen.

6.4 Save Data Settings 1/2

6.4.6 Setting Up the Hard Copy Destination

The DISP COPY key allows you to hard copy a display screen. This section explains how to set up the hard copy destination.

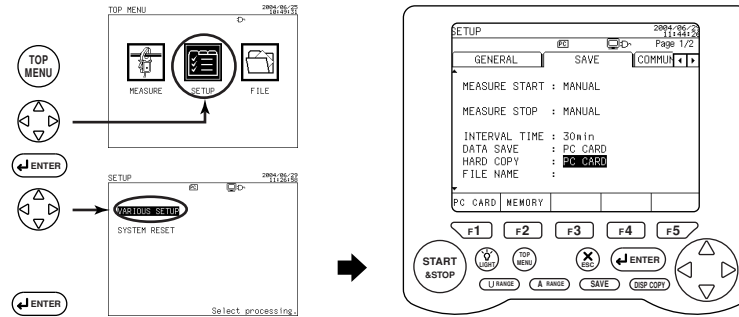

1 Displaying the Save 1/2 screen



Using the right and left cursor keys, select the Save tab (highlighted).

2 Changing the hard copy destination



Using the up and down cursor keys, select HARD COPY (highlighted).

The function key labels change.



Default: PC CARD

3 Setup

F1 to **F3** Press the corresponding function key to set a hard copy destination.

Ending setup:

To also change another setting	To return to the Top Menu
Select a desired setting using the cursor keys.	ENTER key

TIP

- To output to the printer, RS-232 CONNECT must be set to PRINTER in the communication setting. If not, the F3 key (PRINTER) will not be displayed.
- For more information on the printer, see Section 10.3, Using a Printer.

6.4 Save Data Settings 1/2

6.4.7 Setting Up a File Name

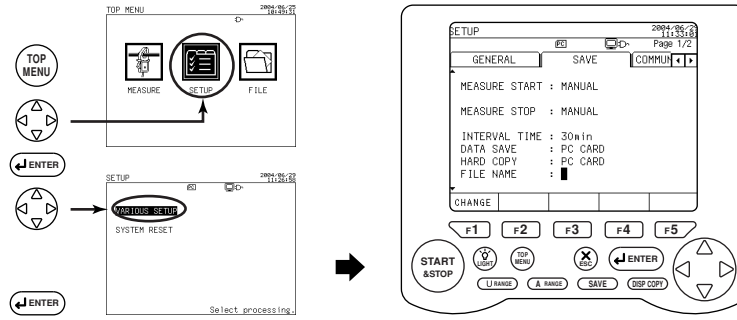

1 Displaying the Save 1/2 screen



Using the right and left cursor keys, select the Save tab (highlighted).

2 Entering a file name



Using the up and down cursor keys, select FILE NAME (highlighted).

3 Displaying the window



Press the F1 key (CHANGE).

The screen switches to an entry screen.

If you do not enter a file name, press the ESC key. The window returns to the Save screen.

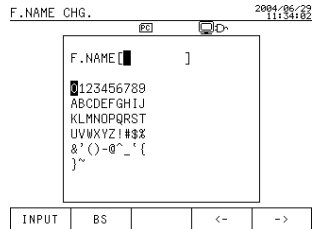

TIP

- If no file name is set, the CW240 automatically assigns a file name.
- For more information on file names, see Section 8.1, Data Save.

● **File Name Input Procedure**

Enter a file name using 8 characters or less (standard alphanumeric characters).

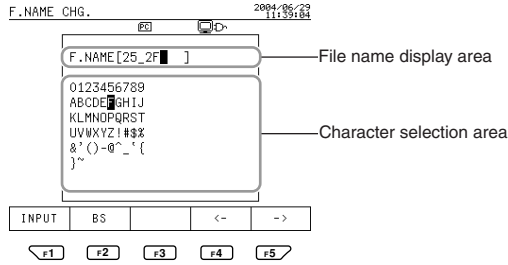

1 **Selecting characters**



Using the cursor keys, select characters (highlighted) to be entered as a file name from among the character selection area.

2 **Input**



Press the F1 key (INPUT).

The selected character is input and the cursor moves to the next input position.

Other function keys:



: BS (back space) key

Deletes a character entered (the one just in front of the cursor).



: ← key

Moves the cursor one character to the left in the file name display area.



: → key

Moves the cursor one character to the right in the file name display area.

Ending setup:

To also change another setting	To return to the Top Menu
Select a desired setting using the cursor keys.	ENTER key

6.5 Save Data Settings 2/2

The Save 2/2 screen allows you to set up the following items.

SETUP 2004.06.18 11:46:18 Page 2/2

GENERAL SAVE COMMUN

E. ENEGRY/DEM. : ON

WAVEFORM DATA : ON

NOR. MEAS. : ON INST. : ON
AVE. : ON

HARM. MEAS. : ON MAX. : ON
DETA. : ON MIN. : ON

SAVE-TIME : 409DAYS 19:30:00

ON OFF

Setting Item	Description
ENERGY data DEM. data	Allows you to set whether or not to save data.
WAVEFORM DATA	Allows you to set whether or not to save data.
NOR. MEAS. data	Allows you to set whether or not to save data.
HARM. MEAS.	Allows you to set whether or not to save data.
HARM. MEAS. DETA.	Allows you to set details such as the number of loads, measured value, and harmonic order.
Common to normal measurement and harmonic measurement	Allows you to set whether or not to save data.
INST.	
AVE.	
MAX.	
MIN.	

SAVE TIME

Indicates the length of time of data that can be saved in the data storage destination based on the remaining capacity of the memory (PC card or internal memory) set to DATA SAVE and the noted data save items.



NOTE

- Setting items cannot be changed during integration measurements (including when on standby).
- Unless integral measured data has been cleared, setting items cannot be changed. To change a setting item, press the F5 key (HOLD/Clear) for more than 3 seconds on the Measure screen to clear integral measured data and then change the setting.

TIP

If the RS232 connection destination is set to PRINTER, the same items as the save items are printed out.

6.5.1 Setting Procedure

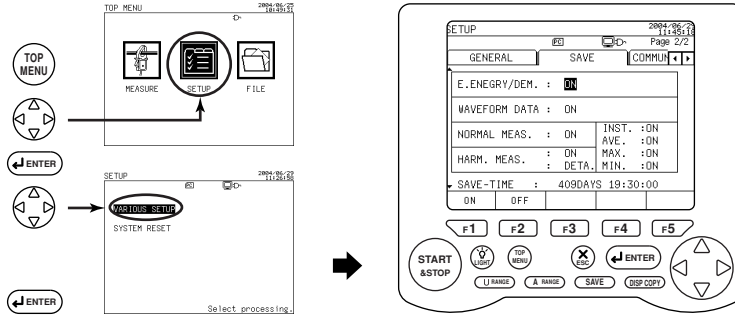

- 1** **Displaying the Save 1/2 screen**
 Using the right and left cursor keys, select the Save tab (highlighted).
- 2** **Displaying the Save 2/2 screen**
 Using the up and down cursor keys, display the Save 2/2 Screen.
- 3** **Changing the setting**
 Using the up and down cursor keys, select a necessary item (highlighted).
 The function key labels change.

ON	OFF			
F1	F2	F3	F4	F5

 Default: ON
- 4** **Setup**
 Press the corresponding function key to set the selected item.
 F1: ON Enables a save/print.
 F2: OFF Disables a save/print.

Ending setup:

To also change another setting	To return to the Top Menu
Select a desired setting using the cursor keys.	ENTER key

6.5 Save Data Settings 2/2

6.5.2 Setting Up the Detailed Save Items of Harmonic Data

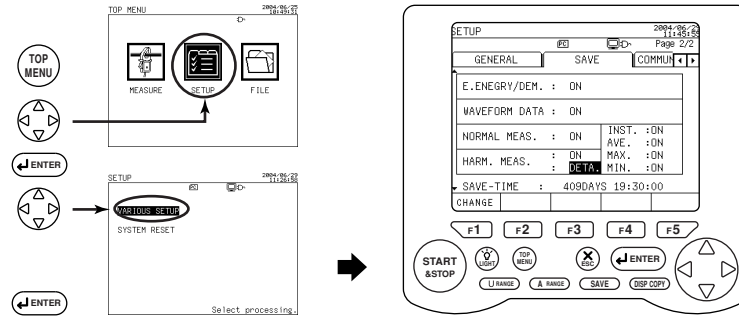

1 Displaying the Save 1/2 screen

Using the right and left cursor keys, select the Save tab (highlighted).



2 Displaying the Save 2/2 screen

Using the up and down cursor keys, display the Save 2/2 screen.



3 Changing a save item

Using the up and down cursor keys, select HARM. MEAS. DETA. (highlighted).

4 Displaying the window



Press the F1 key (CHANGE).

The window showing detailed items appears.

Number of loads

HARMONIC OUTPUT ITEMS			
LOAD1	ON	U1	DN
LOAD2	OFF	U2	DN
LOAD3	OFF	U3	DN
LOAD4	OFF	P	DN
		I1	DN
		I2	DN
		I3	DN
		I4	OFF
OUTPUT ORDER : SELECT			
#	01*	02*	03*
#	11*	12*	13*
#	21*	22*	23*
#	31*	32*	33*
#	41*	42*	43*
	ON	OFF	

U1 to U3: Voltage value

P: Active power

I1 to I4: Current value

Orders

● Procedure for Setting the Number of Loads/Measured Value

SETUP 2004-06-25
13:26:52

HARMONIC OUTPUT ITEMS

LOAD1	DN	I1	DN	I1	DN	LEVEL	DN
LOAD2	OFF	I2	DN	I2	DN	CONTENT	DN
LOAD3	OFF	I3	DN	I3	DN	PA	DN
LOAD4	OFF	P	DN	I4	OFF	TOTAL	DN
						THD	DN

OUTPUT ORDER :SELECT

* 01*	02*	03*	04*	05*	06*	07*	08*	09*	10*
* 11*	12*	13*	14*	15*	16*	17*	18*	19*	20*
* 21*	22*	23*	24*	25*	26*	27*	28*	29*	30*
* 31*	32*	33*	34*	35*	36*	37*	38*	39*	40*
* 41*	42*	43*	44*	45*	46*	47*	48*	49*	50*
ON	OFF								

1 Changing an item



Using the cursor keys, select a necessary item (highlighted).
The function key labels change.

ON	OFF			
F1	F2	F3	F4	F5

Default: ON

2 Setup



Press the corresponding function key to set the selected item.

F1: ON Enables a save/print.
F2: OFF Disables a save/print.

NOTE

- Items that can be set as saved items vary depending on the wiring and load number settings.
- If wiring is set to a Scott connection, make settings with reference to the three-phase (3P3W) side. If items that can be selected are different between the three-phase (3P3W) side and the single-phase (1P3W) side, a ">" symbol follows the item in order to show that it is effective on the 1P3W side.

Example: I1>

6.5 Save Data Settings 2/2

● Harmonic Order Setting Procedure

Harmonic orders that have been set to be saved will be assigned an * (asterisk) mark.

1 Changing an item



Using the cursor keys, select **OUTPUT ORDER** (highlighted).

The function key labels change.

ALL ORD.	ODD	EVEN	SELECT	
F1	F2	F3	F4	F5

Default: ALL ORD.

2 Setup

F1 to F4 Press the corresponding function key to set the harmonic orders.

F1: Saves/prints all orders of harmonics (1st to 50th).

F2: Saves odd orders of harmonics (1st, 3rd, ...).

F3: Saves even orders of harmonics (2nd, 4th, ...).

F4: Allows you to select harmonic orders individually.

● If selecting harmonic orders individually

1 Changing an item



Using the cursor keys, select a harmonic order that needs to be changed (highlighted).

The function key labels change.

ON	OFF			
F1	F2	F3	F4	F5

Default: ON

2 Setup

F1, F2 Press the corresponding function key to set the selected order.

F1: ON Enables a save/print.

F2: OFF Disables a save/print.

Ending setup:

To also change another setting	To return to the Top Menu
Select a desired setting using the cursor keys.	ENTER key

6.6 Communication Settings

This section explains how to configure the RS-232 communication setup.

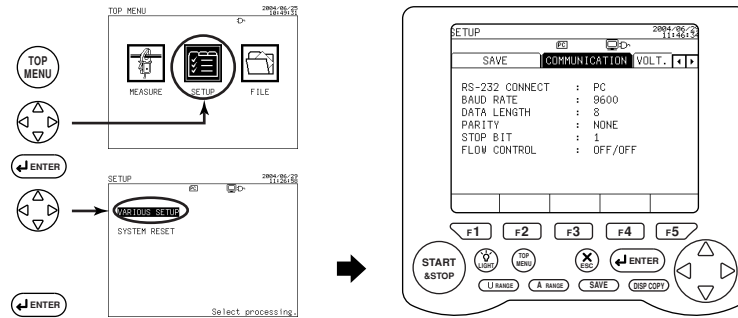

1 Displaying the Communication screen



Using the right and left cursor keys, select the Communication tab (highlighted).

TIP

Even if a system reset is made, the communication settings are not reset to the factory-shipped settings.

SEE ALSO

For more information on communications, refer to the Communication Function Manual in the supplied CD-ROM.

6.6 Communication Settings

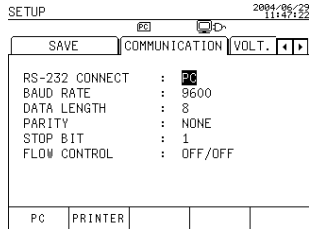

● RS232 Connection Destination Setting Procedure

1

Changing an item



Using the up and down cursor keys, select RS-232 CONNECT (highlighted).

The function key labels change.



Default: PC

2

Setup



F1, F2

Press the corresponding function key to set a desired destination.

F1: Connects to a PC.

F2: Connects to a printer.

● Baud Rate Setting Procedure

1

Changing an item



Using the up and down cursor keys, select BAUD RATE (highlighted).

2

Displaying the window



F1

Press the F1 key (CHANGE).

The window for selecting a baud rate appears.

Unit: bps

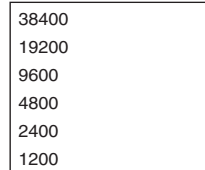

Default: 9600

3 Selecting a baud rate



Using the cursor keys, select a desired baud rate (highlighted).

To cancel changing the setting, press the ESC key. The window returns to the Communication screen.

4 Confirmation



Press the ENTER key.

This closes the window, returning you to the Communication screen. The selected baud rate is displayed on the screen.

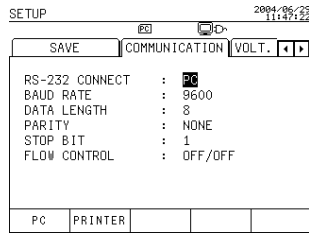

● Data Length Setting Procedure

1 Changing an item



Using the up and down cursor keys, select DATA LENGTH (highlighted).

The function key labels change.



Default: 8

2 Setup



Press the corresponding function key to set a desired data length.

F1: 7 bits

F2: 8 bits

6.6 Communication Settings

● Parity Setting Procedure

1 Changing an item



Using the up and down cursor keys, select **PARITY** (highlighted).

The function key labels change.

EVEN	ODD	NONE		
F1	F2	F3	F4	F5

Default: NONE

2 Setup

F1 to F3 Press the corresponding function key to set a desired parity.

F1: Even parity

F2: Odd parity

F3: None

```
SETUP                                     2004.05.22
                                     11:47:22
SAVE COMMUNICATION VOLT. 1 1
RS-232 CONNECT : PC
BAUD RATE      : 9600
DATA LENGTH    : 8
PARITY         : NONE
STOP BIT       : 1
FLOW CONTROL   : OFF/OFF
PC PRINTER
```

● Stop Bit Setting Procedure

1 Changing an item



Using the up and down cursor keys, select **STOP BIT** (highlighted).

The function key labels change.

1	2			
F1	F2	F3	F4	F5

Default: 1

2 Setup

F1, F2 Press the corresponding function key to set a desired stop bit.

F1: 1 bit

F2: 2 bits

● Flow Control Setting Procedure

1 Changing an item



Using the up and down cursor keys, select **FLOW CONTROL** (highlighted).

The function key labels change.

OFF/OFF	XON/XON	XON/RS	CS/RS	
F1	F2	F3	F4	F5

Default: OFF/OFF

2 Setup

F1 to **F4** Press the corresponding function key to set flow control.

Ending setup:

To also change another setting	To return to the Top Menu
Select a desired setting using the cursor keys.	ENTER key

NOTE

If the interval time is set to 30 sec or less, there may be situations when items to be set are automatically changed.

If RS-232 CONNECT has been set to PRINTER, PC is selected instead.

If HARD COPY has been set to PRINTER, PC CARD is selected instead.

The mark, which indicates that only manual printing using the SAVE key or DISP COPY key is effective, is displayed. Note that automatic printout of data is not allowed as long as this mark is displayed.

6.7 Voltage Quality Settings

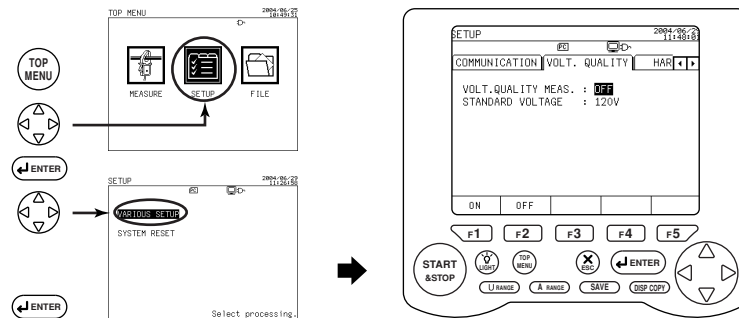

1 Displaying the VOLT. QUALITY screen



Using the right and left cursor keys, select the Volt. Quality tab (highlighted).

● Enabling/Disabling Voltage Quality Measurement

1 Changing the setting



Using the up and down cursor keys, select VOLT. QUALITY MEAS. (highlighted).

The function key labels change.

ON	OFF			
F1	F2	F3	F4	F5

Default: OFF/OFF

2 Setup



Press the corresponding function key to set whether to enable voltage quality measurement.

F1: ON Enables voltage quality measurement.

F2: OFF Disables voltage quality measurement.

To perform voltage quality measurement, also set up the standard voltage, threshold value, and hysteresis.

● Setting the Standard Voltage

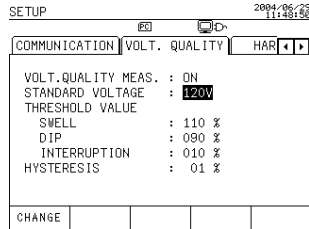

1 Changing an item



Using the up and down cursor keys, select STANDARD VOLTAGE (highlighted).

The function key labels change.



2 Displaying the window



Press the F1 key (CHANGE).

The window for selecting the standard voltage appears.

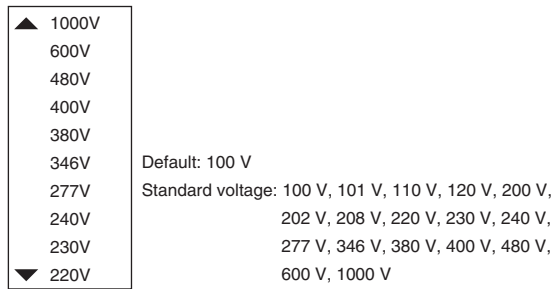

3 Selecting the standard voltage



Using the cursor keys, select a desired standard voltage (highlighted).

To cancel changing the setting, press the ESC key. The window returns to the Volt. Quality screen.

4 Confirmation



Press the ENTER key.

This closes the window, returning you to the Volt. Quality screen.

NOTE

If wiring is Scott connection, set up the 3P3W-side standard voltage. The 1P3W-side standard voltage will be automatically set to half the standard voltage set to the 3P3W side.

6.7 Voltage Quality Settings

● Setting the Threshold Value

	Setting Range (with Respect to Standard Voltage)	Default (%)
Voltage Swell	0 to 200%	110
Voltage Dip	0 to 100%	90
Instantaneous Voltage Interruption	0 to 100%	10

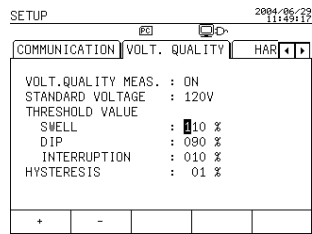

1 Changing an item



Using the up and down cursor keys, select a necessary item (highlighted).

The function key labels change.

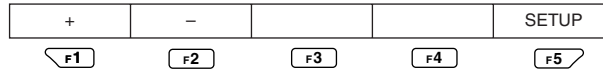

2 Setup

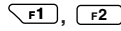

Press the corresponding function key to set the desired threshold value.

F1: + Increments a value.

F2: - Decrements a value.

Ending setup:

To also change another setting	To return to the Top Menu
Select a desired setting using the cursor keys.	ENTER key

● Setting Hysteresis

Setting Range

	Setting Range (with Respect to Standard Voltage)	Default (%)	Hysteresis applies in common to the following three items:
Hysteresis	0 to 10%	1	Voltage swell Voltage dip Instantaneous voltage interruption

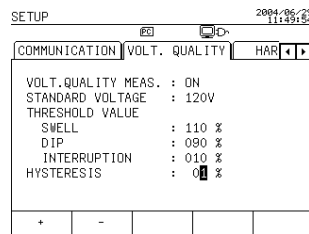

1 Changing an item



Using the up and down cursor keys, select **HYSTERESIS** (highlighted).

The function key labels change.



2 Setup

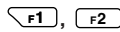

Press the corresponding function key to set a desired hysteresis.

F1: + Increments a value.

F2: - Decrements a value.

Ending setup:

To also change another setting	To return to the Top Menu
Select a desired setting using the cursor keys.	ENTER key

6.8 Hardware Settings

The Hardware screen allows you to set up the following items.

Setting Item	Description
LANGUAGE	Sets the display language such as English, Japanese, etc.
BEEP	Sets whether to generate a beep when an operation key is pressed.
BACKLIGHT AUTO OFF	Sets whether to activate automatic backlight OFF if no key is pressed for more than 10 minutes.
LCD CONTRAST	Sets LCD contrast (1 to 8).
ZERO CROSS FILTER	Sets whether to insert a zero cross filter into the frequency circuit.
ID NUMBER	Sets an ID number (001 to 999) as an instrument number or the number of a measurer, etc.
DATE AND TIME	Sets date and time (accurate time entry).

The General 2/2 screen allows you to set up the zero cross filter. For more information on the zero cross filter, see Section 6.3, General Settings 2/2, and to set up the filter, see 6.8.5, Setting Up ON/OFF of a Zero Cross Filter.

 **NOTE**

- The following setting items cannot be changed during integration measurements (including when on standby).
- Unless integral measured data has been cleared, the following setting items cannot be changed.

To change any of them, press the F5 key (HOLD/Clear) for more than 3 seconds on the Measure screen to clear integral measured data and then change the setting.

Setting items: ZERO CROSS FILTER, ID NUMBER, and DATE AND TIME

6.8 Hardware Settings

6.8.1 Setting Up the Display Language

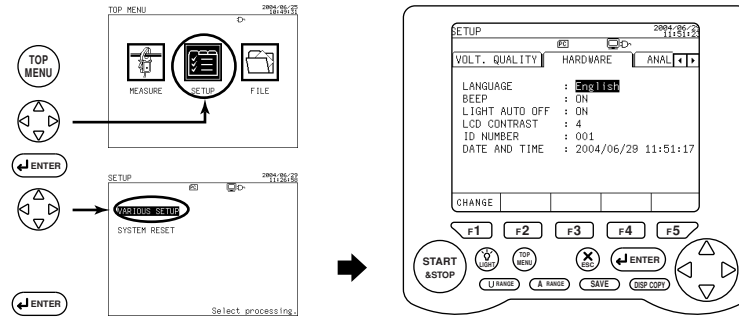

1 Displaying the Hardware screen



Using the right and left cursor keys, select the Hardware tab (highlighted).

2 Changing the display language



Using the up and down cursor keys, select LANGUAGE (highlighted).

3 Displaying the window



Press the F1 key (CHANGE).

The window for selecting the language appears.

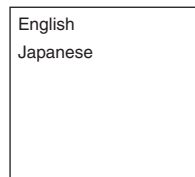

Default: English

4 Selecting the language

Using the cursor keys, select the desired language (highlighted).

To cancel changing the setting, press the ESC key. The window returns to the Hardware screen.

5 Confirmation

Press the ENTER key.

This closes the window, returning you to the Hardware screen.

Ending setup:

To also change another setting	To return to the Top Menu
Select a desired setting using the cursor keys.	ENTER key

TIP

Even if a system reset is made, the LANGUAGE setting is not reset to the factory-shipped setting.

6.8 Hardware Settings

6.8.2 Setting Up ON/OFF of a Beep

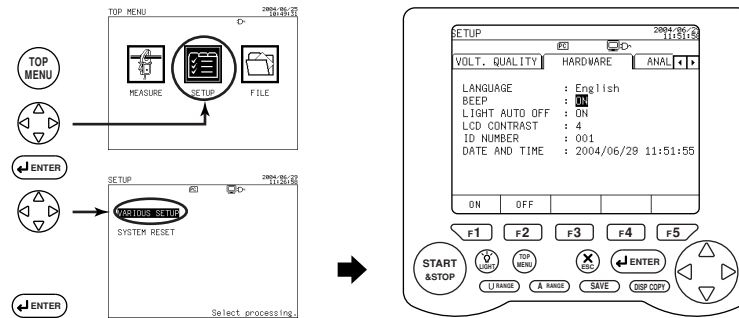

1 Displaying the Hardware screen



Using the right and left cursor keys, select the Hardware tab (highlighted).

2 Changing a beep



Using the up and down cursor keys, select BEEP (highlighted).

The function key labels change.



Default: ON

3 Setup



Press the corresponding function key to set ON/OFF of a beep.

F1: ON A beep is generated each time a key is pressed.

F2: OFF Disables generation of a beep.

Ending setup:

To also change another setting	To return to the Top Menu
Select a desired setting using the cursor keys.	ENTER key

6.8.3 Setting Up Auto Backlight OFF

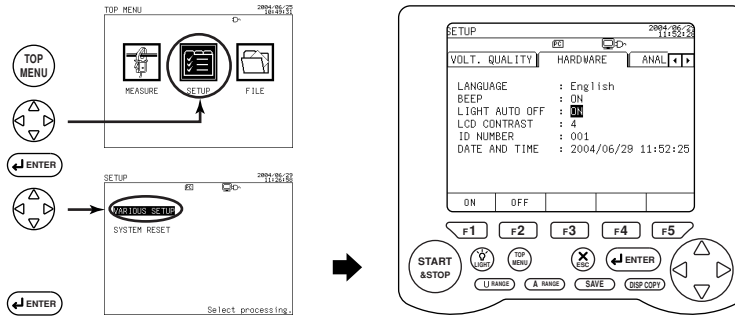

1 Displaying the Hardware screen



Using the right and left cursor keys, select the Hardware tab (highlighted).

2 Changing activation of backlight auto OFF



Using the up and down cursor keys, select BACKLIGHT AUTO OFF (highlighted).

The function key labels change.



Default: ON

3 Setup

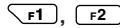

Press the corresponding function key to activate/deactivate auto backlight OFF.

F1: ON Activates auto backlight OFF if no key is pressed for more than 10 minutes.

F2: OFF Lets the backlight remain ON.

Ending setup:

To also change another setting	To return to the Top Menu
Select a desired setting using the cursor keys.	ENTER key

6.8 Hardware Settings

6.8.4 Setting Up the LCD Contrast

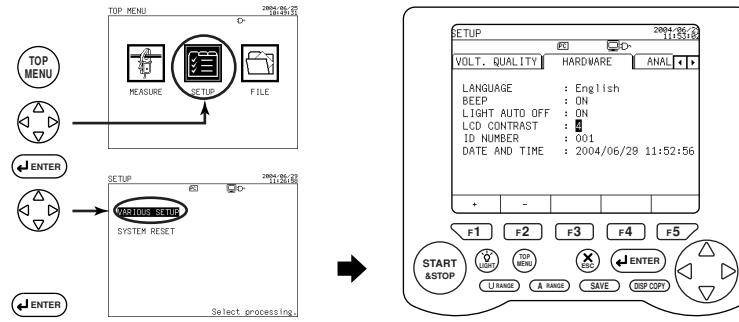

1 Displaying the Hardware screen



Using the right and left cursor keys, select the Hardware tab (highlighted).

2 Changing the contrast



Using the up and down cursor keys, select LCD CONTRAST (highlighted).

The function key labels change.

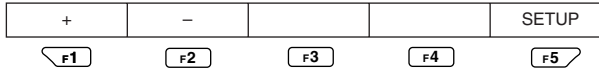

Default: 4

3 Setup

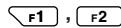

Press the corresponding function key to set the contrast.

F1 : + Increments a value (1 → 2 → 3 → 4 → 5 → 6 → 7 → 8 → 1).

F2 : - Decrements a value (8 → 7 → 6 → 5 → 4 → 3 → 2 → 1 → 8).

The setting range of LCD contrast is 1 to 8.

Ending setup:

To also change another setting	To return to the Top Menu
Select a desired setting using the cursor keys.	ENTER key

6.8.5 Setting Up ON/OFF of a Zero Cross Filter

A low-pass filter can be inserted in the frequency circuit to eliminate noises such as inverter waveform and distorted waves in order to measure the frequency accurately.

(Cut-off frequency: 300 Hz)

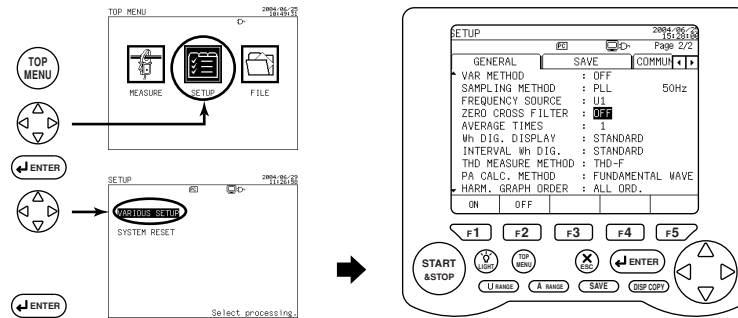

1 Displaying the Hardware screen



Using the right and left cursor keys, select the Hardware tab (highlighted).

2 Changing ON/OFF of the zero cross filter



Using the up and down cursor keys, select ZERO CROSS FILTER (highlighted).

The function key labels change.



Default: ON

3 Setup



Press the corresponding function key to ON/OFF of the zero cross filter.

- F1 : ON Inserts the zero cross filter.
- F2 : OFF Disables insertion of the zero cross filter.

Ending setup:

To also change another setting	To return to the Top Menu
Select a desired setting using the cursor keys.	ENTER key

6.8 Hardware Settings

6.8.6 Setting Up the ID Number

If multiple CW240s are used, an ID number can be entered as an instrument number or the number of a measurer or management department.

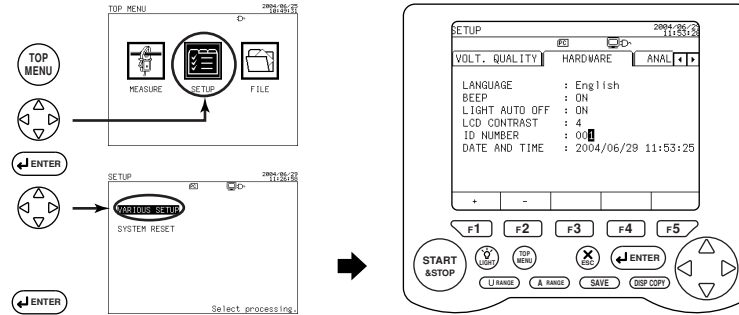

1 Displaying the Hardware screen



Using the right and left cursor keys, select the Hardware tab (highlighted).

2 Changing the ID number

Using the up and down cursor keys, select ID NUMBER (highlighted).

The function key labels change.

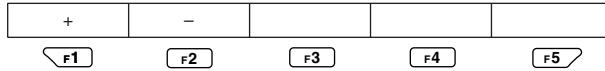

Default: 001

3 Setup

Press the corresponding function key to set the ID number.

F1 : + Increments a number.

F2 : - Decrements a number.

The setting range of the ID number is from 001 to 999.

Ending setup:

To also change another setting	To return to the Top Menu
Select a desired setting using the cursor keys.	ENTER key

TIP

Even if a system reset is made, the ID number setting is not reset to the factory-shipped setting.

6.8 Hardware Settings

6.8.7 Setting Up the Date and Time

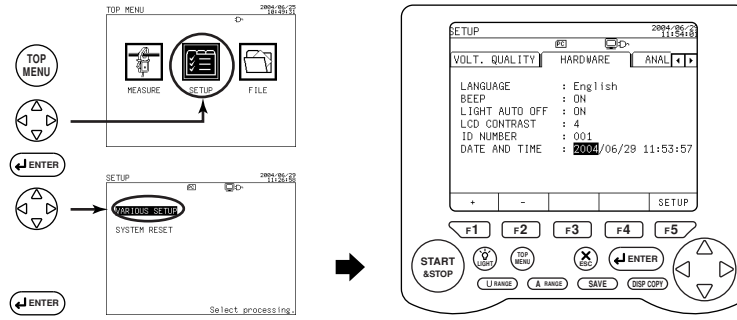

1 Displaying the Hardware screen



Using the right and left cursor keys, select the Hardware tab (highlighted).

2 Changing the date and time



Using the up and down cursor keys, select DATE AND TIME (highlighted).

The function key labels change.



3 Selecting an item

Using the right and left cursor keys, select an item to change (highlighted).

Year / Month / Day / Hour / Minute

4 Input

Press the corresponding function key to input a value.

F1 : + Increments a value.

F2 : - Decrements a value.

Repeat steps **3** and **4** to set year/month/day/hour/minute data.

5 Setup

Press this function key to complete the setting.

This causes the date and time data at the upper right of the screen to be updated.

Ending setup:

To also change another setting	To return to the Top Menu
Select a desired setting using the cursor keys.	ENTER key

TIP

The setting range of the date and time is from 2000/01/01 0:00 to 2099/12/31 23:59. Even if a system reset is made, the date and time settings are not reset to the factory-shipped settings.

6.9 Analog I/O Settings

The CW240 has 4-channel analog output (DA output) and 2-channel analog input functions (optional).

For analog output, set up the measured value output on each channel (CH). For analog input, set up the voltage range of each channel (CH).

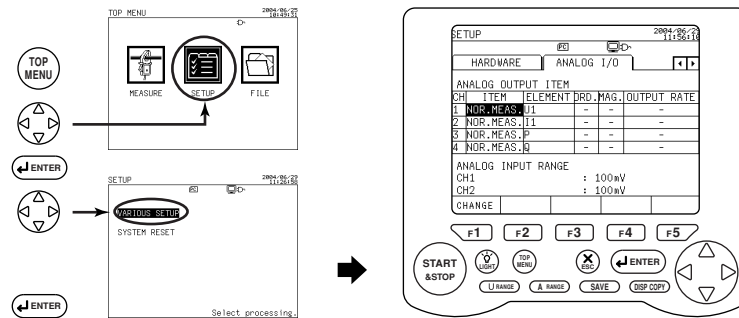

1 Displaying the Analog I/O Screen



Using the right and left cursor keys, select the Analog I/O tab (highlighted).

NOTE

- Setting items cannot be changed during integration measurements (including when on standby).
- Unless integral measured data has been cleared, setting items cannot be changed. To change a setting item, press the F5 key (HOLD/Clear) for more than 3 seconds on the Measure screen to clear integral measured data and then change the setting.

SEE ALSO

For more information on analog input/output, see Chapter 13, Using Analog Input/Output (Options).

● Setting Information of Analog Output Items

Item	Element	Order	Magnification	Output Rate	
NORMAL	Voltage (U1, U2, U3, Uave) Current (I1, I2, I3, I4, Iave) Power (P) Reactive power (Q) Apparent power (S) Power factor (PF) Phase angle (PA) Frequency (F)	–	–	–	
E. ENERGY	Active energy (Wh+) Regenerative energy (Wh-) Lagging reactive energy (Varh+) Leading reactive energy (Varh-)	–	–	1V/1kWh 1V/5kWh 1V/10kWh 1V/50kWh 1V/100kWh 1V/500kWh 1V/1000kWh	
Harmonics	LEVEL	Voltage (U1, U2, U3) Current (I1, I2, I3, I4) Power (P)	1 to 50	1, 10, and 100 times	–
	CONTENT	Voltage (U1, U2, U3) Current (I1, I2, I3, I4) Power (P)	1 to 50	1, 10, and 100 times	–
	HARM. PA	Voltage (U1, U2, U3) Current (I1, I2, I3, I4) Power (P)	1 to 50	–	–
	TOTAL VAL	Voltage (U1, U2, U3) Current (I1, I2, I3, I4) Power (P)	–	–	–
	THD	Voltage (U1, U2, U3) Current (I1, I2, I3, I4)	–	–	–

 NOTE

- Analog output items that can be set vary depending on the wiring.
- For measurement of multiple loads, analog output items can be selected on a load basis. A number representing load(s) is appended following each element (e.g., I1_1, I1_2, P_1, and P_2).
- For Scott connections, a symbol representing which load is applied is appended following each element (e.g., U1_3P, U1_1P, P_3P, and P_1P).

6.9 Analog I/O Settings

● Analog Output Item Setting Procedure

SETUP 2004/06/29
11:08:10

HARDWARE	ANALOG I/O	◀▶	
ANALOG OUTPUT ITEM			
CH	ITEM	ELEMENT	DRD. MAG. OUTPUT RATE
1	NOR. MEAS. I1	-	-
2	NOR. MEAS. I1	-	-
3	NOR. MEAS. P	-	-
4	NOR. MEAS. Q	-	-
ANALOG INPUT RANGE			
CH1	: 100mV		
CH2	: 100mV		
CHANGE			

1 Changing an item



Using the up and down cursor keys, select an item of CH to be changed (highlighted).

2 Displaying the window



Press the F1 key (CHANGE).

The window showing analog output items appears.

THD
Total Value
Harmonic PA
Content
Level
E. Energy
Normal Measure

Default: Normal Measure

3 Selecting an item



Using the cursor keys, select a desired analog output item (highlighted).

To cancel changing the setting, press the ESC key. The window returns to the Analog I/O screen.

4 Confirmation



Press the ENTER key.

This closes the window, returning you to the Analog I/O screen.

Perform the same steps for the items of CH1 to CH4.

Ending setup:

To also change another setting	To return to the Top Menu
Select a desired setting using the cursor keys.	ENTER key

● Element Setting Procedure

In element setting, the element to be selected differs depending on the item previously set. Check this by referring to the Setting Information of Analog Output Items table.

The following describes the setting procedure, using the example of selecting NORMAL as an output item.

Item	Element	Order	Magnification	Output Rate
NORMAL	Voltage (U1, U2, U3, Uave)			
	Current (I1, I2, I3, I4, Iave)			
	Power (P)			
	Reactive power (Q)	-	-	-
	Apparent power (S)			
	Power factor (PF)			
	Phase angle (PA)			
	Frequency (F)			

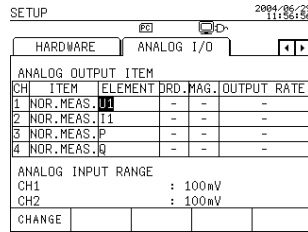

1 Changing an element



Using the cursor keys, select an element of CH to be changed (highlighted).

6.9 Analog I/O Settings

2 Displaying the window



Press the F1 key (CHANGE).

The window showing elements appears.

f
PA
PF
S
Q
P
I1
U1

3 Selecting an element



Using the cursor keys, select a desired element (highlighted).

To cancel changing the setting, press the ESC key. The window returns to the Analog I/O screen.

4 Confirmation



Press the ENTER key.

This closes the window, returning you to the Analog I/O screen.

Perform the same steps for the items of CH1 to CH4.

Ending setup:

To also change another setting	To return to the Top Menu
Select a desired setting using the cursor keys.	ENTER key

● **Order Setting Procedure**

The order needs to be set when the analog output item is set to LEVEL, CONTENT, or HARM. PA.

Set up the harmonic order to be saved (output) from among 1st to 50th orders.

Item	Element	Order	Magnification	Output Rate
LEVEL	Voltage (U1, U2, U3)	1 to 50	1, 10, and 100 times	-
	Current (I1, I2, I3, I4)			
	Power (P)			
CONTENT	Voltage (U1, U2, U3)	1 to 50	1, 10, and 100 times	-
	Current (I1, I2, I3, I4)			
	Power (P)			
HARM. PA	Voltage (U1, U2, U3)	1 to 50	-	-
	Current (I1, I2, I3, I4)			
	Power (P)			

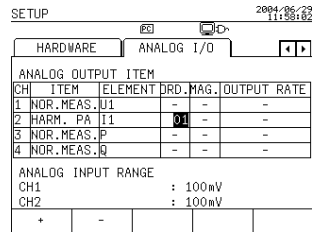

1 Changing the order



Using the cursor keys, select the order of CH (highlighted).

The function key labels change.



2 Setup

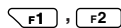

Press the corresponding function key to set the order.

F1 : + Increments a value.

F2 : - Decrements a value.

Ending setup:

To also change another setting	To return to the Top Menu
Select a desired setting using the cursor keys.	ENTER key

6.9 Analog I/O Settings

● Magnification Setting Procedure

The output magnification needs to be set when the analog output item is set to LEVEL or CONTENT. Select it from among 1 time, 10 times, and 50 times.

Item	Element	Order	Magnification	Output Rate
LEVEL	Voltage (U1, U2, U3)	1 to 50	1, 10, and 100 times	-
	Current (I1, I2, I3, I4)			
	Power (P)			
CONTENT	Voltage (U1, U2, U3)	1 to 50	1, 10, and 100 times	-
	Current (I1, I2, I3, I4)			
	Power (P)			

SETUP 2004.06.23 11:59:24

HARDWARE		ANALOG I/O		
ANALOG OUTPUT ITEM				
CH	ITEM	ELEMENT	DRD. MAG.	OUTPUT RATE
1	NOR. MEAS. U1	-	-	-
2	HARM. PA I1	-	01	-
3	CONTENT P	-	01	-
4	NOR. MEAS. Q	-	-	-
ANALOG INPUT RANGE				
CH1		: 100mV		
CH2		: 100mV		
1	10	100		

1 Changing the magnification



Using the cursor keys, select **MAG.** (highlighted).

The function key labels change.

1	10	100		
F1	F2	F3	F4	F5

Default: 1

2 Setup

F1 to **F3** Press the corresponding function key to set the magnification.

F1 : 1 time

F2 : 10 times

F3 : 100 times

Ending setup:

To also change another setting	To return to the Top Menu
Select a desired setting using the cursor keys.	ENTER key

TIP

The output full scale changes depending on the magnification setting.

If the output item is LEVEL

Magnification	Full Scale
1	20A
10	2A
100	0.2A

If the output item is CONTENT

Magnification	Full Scale
1	100%
10	10%
100	1%

● **Output Rate Setting Procedure**

The output rate needs to be set when the analog output item is set to E. ENERGY.

Item	Element	Order	Magnification	Output Rate
E. ENERGY	Active energy (Wh+)	-	-	1V/1kWh
	Regenerative energy (Wh-)			1V/5kWh
	Lagging reactive energy (Varh+)			1V/10kWh
	Leading reactive energy (Varh-)			1V/50kWh
				1V/100kWh
				1V/500kWh
				1V/1000kWh

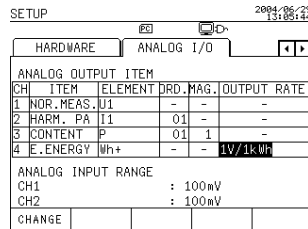

1

Changing the output rate



Using the cursor keys, select the output rate of CH to be changed (highlighted).

6.9 Analog I/O Settings

2 Displaying the window



Press the F1 key (CHANGE).

The window showing elements appears.

Active energy (Wh+) Regenerative energy (Wh-)	Lagging reactive energy (Varh+) Leading reactive energy (Varh-)
1V/1000kWh	1V/1000kVarh
1V/500kWh	1V/500kVarh
1V/100kWh	1V/100kVarh
1V/50kWh	1V/50kVarh
1V/10kWh	1V/10kVarh
1V/5kWh	1V/5kVarh
1V/1kWh	1V/1kVarh

Default: 1 V/1 kWh

3 Selecting an element



Using the cursor keys, select a desired item (highlighted).

To cancel changing the setting, press the ESC key. The window returns to the Analog I/O screen.

4 Confirmation



Press the ENTER key.

This closes the window, returning you to the Analog I/O screen.

Perform the same steps for the items of CH1 to CH4.

Ending setup:

To also change another setting	To return to the Top Menu
Select a desired setting using the cursor keys.	ENTER key

● **Analog Input Range**

Analog input can be selected from among the following three ranges:
100 mV, 1 V, and 5 V

● **Input Range Setting Procedure**

SETUP 2004-06-23
13:00:54

HARDWARE		ANALOG I/O		[4]	
ANALOG OUTPUT ITEM					
CH	ITEM	ELEMENT	DRD. MAG.	OUTPUT RATE	
1	NOR. MEAS. U1	-	-	-	
2	HARM. PA I1	01	-	-	
3	CONTENT P	01	1	-	
4	E. ENERGY Wh+	-	-	1V/1kWh	
ANALOG INPUT RANGE					
CH1		: 100mV			
CH2		: 100mV			
100mV	1V	5V			

1 Changing the range



Using the cursor keys, select the range of CH to be changed (highlighted).

The function key labels change.

100mV	1V	5V			
F1	F2	F3	F4	F5	

Default: 100 mV

Ending setup:

To also change another setting	To return to the Top Menu
Select a desired setting using the cursor keys.	ENTER key

Chapter 7 Measurements

7.1	Measurements	7-2
7.2	Measure Screens	7-3
7.3	Measuring Electric Energy	7-13
7.4	Measuring Demand	7-17
7.5	Displaying Zoom (Expanded View)	7-21
7.6	Measuring Harmonics	7-24
7.7	Displaying Waveform	7-34
7.8	Measuring Voltage Quality (Voltage Dip, Voltage Swell, Instantaneous Interruption)	7-40
7.9	Checking Settings	7-43
7.10	Clearing Integrated Data	7-45
7.11	Measurement Data	7-46

7.1 Measurements

Model CW240 offers integration measurement in which the start and stop times of integration are set up to carry out a measurement, and instantaneous value measurement in which no integration is conducted.

● Screens for Checking Measured Data

Measure Screens F1 key (DISPLAY CHANGE)	Description	
LIST	Displays a list of measured data.	INST. *1 AVE MAX. MIN.
POWER	Displays measured data of power (details)	
INTEGRATE	Displays measured data of electric energy. (Integration measurement)	
DEMAND	Displays measured data of demand. (Integration measurement)	
ZOOM (Expanded View)	Allows five items to be zoomed.	
HARMONIC	Analyzes 1st to 50th harmonics. Allows you to display three screens: LIST, GRAPH, and VECTOR.	
WAVEFORM	Allows you to display U&I WAVEFORM, U WAVEFORM, and I WAVEFORM.	
VOLT. QUALITY (Voltage Fluctuation)	Allows you to display voltage swell, voltage dip, and instantaneous voltage interruption.	

*1: AVE, MAX., and MIN. indicate values obtained at interval time (during integration measurement).

● Saving Measured Data

You can save measured data in the CW240's internal memory or on a PC card. (It can also be output (printed out) to the dedicated printer (optional).)

For more information on saving measured data, see Chapter 8, Saving Measured Data, Chapter 6, Configuring Settings, Section 6.4, Save Data Settings 1/2, and Section 6.5, Save Data Settings 2/2.

● Setting up Conditions Necessary for Measurements

It is necessary to set up the conditions for integration measurement, data save, and so on beforehand. For more information on setup and setting procedures, see Chapter 6, Configuring Settings.

SEE ALSO

For more information on items to be measured, see Section 7.11, Measurement Data.

7.2 Measure Screens

7.2.1 Switching a Screen

CAUTION

Before conducting a measurement, read through Chapter 3, Preparation for Safe Measurements, and Chapter 4, Wiring.

The CW240 has the following 10 types of Measure screens (measured-value display):

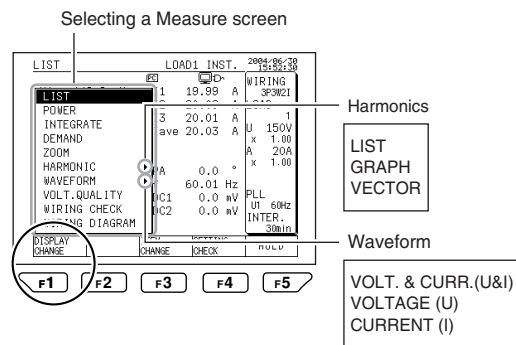

- Harmonic measurements can be displayed in three screens: LIST, GRAPH, and VECTOR.
- Waveform measurement can be displayed in three screens: U&I WAVEFORM, U WAVEFORM, and I WAVEFORM.

7.2 Measure Screens

● Displaying a Measure Screen

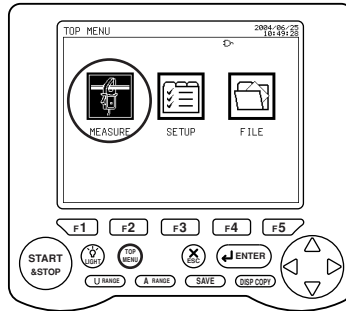

1 Displaying the Top Menu screen



Press the TOP MENU key.

The Top Menu screen appears.

2 Selecting measurement



Using the cursor key, select MEASURE.

The item is highlighted.

3 Confirmation



Press the ENTER key to confirm it.

A Measure screen appears.

● Switching a Measure Screen

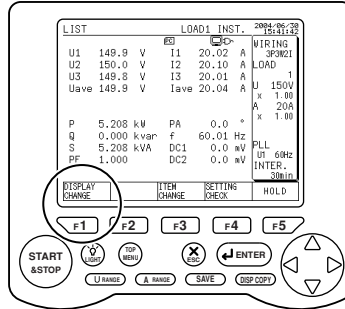

The following describes the screen-switching procedure taking the LIST screen as an example.

1 Displaying the Display Change window



Press the F1 key.

The Display Change window appears.

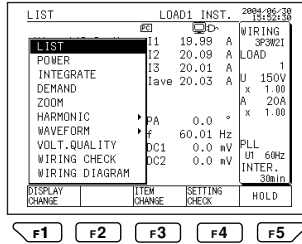

2 Selecting a Measure screen



Using the cursor key, select the Measure screen you want to display (highlighted).

3 Confirmation



Press the ENTER key to confirm it.

The selected Measure screen appears.

7.2 Measure Screens

7.2.2 Description of Display

● Description of Display

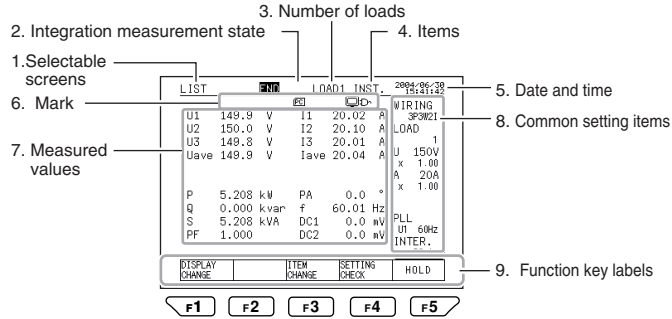

● Display Information

1	Selectable screens	LIST POWER INTEGRATE DEMAND ZOOM HARMONIC (LIST, GRAPH, VECTOR) WAVEFORM (U&I, U, I) VOLT. QUALITY WIRING DIAG. WIRING CHECK	F1 (DISPLAY CHANGE)
2	Integration measurement state	STANDBY INTEG. END	—
3	Number of loads	LOAD (no switching is made in the case of a single load) If wiring is a Scott connection, switching is made between the 3-phase side (3P3W) and single-phase side (1P3W).	F2 (LOAD CHANGE)

7.2 Measure Screens

4	Items	For the List and Power screens INST. AVE MAX. MIN.	F3 (ITEM CHANGE)																										
		For the Volt. Quality screen ALL SWELL DIP INTER.	F2 (ITEM CHANGE)																										
5	Date and time	This field shows the current date and time.																											
6	Mark	This field shows a mark. For more information on marks, see Section 2.6, Description of Mark Indication.																											
7	Measured values	This area displays measured values, a graph, a vector diagram, or waveform.																											
8	Common setting items	Setting Items																											
		<table border="1"> <thead> <tr> <th>Display Example</th> <th>Description</th> </tr> </thead> <tbody> <tr> <td>3P3W2I</td> <td>Wiring</td> </tr> <tr> <td>1</td> <td>Number of loads *1</td> </tr> <tr> <td>U 150V</td> <td>Voltage range</td> </tr> <tr> <td>× 001.00</td> <td>VT ratio</td> </tr> <tr> <td>A 50A</td> <td>Current range</td> </tr> <tr> <td>× 001.00</td> <td>CT ratio</td> </tr> <tr> <td>I4 500mA</td> <td>I4 current range</td> </tr> <tr> <td>× 001.00</td> <td>I4 CT ratio</td> </tr> <tr> <td>PLL</td> <td>Sampling method *2</td> </tr> <tr> <td>U1 50Hz</td> <td>Frequency source (Fixed clock) frequency</td> </tr> <tr> <td>Interval 30 min</td> <td>Interval time</td> </tr> </tbody> </table> <p>*1 If a Scott connection (3P3W + 1P3W) is selected for wiring</p> <table border="1"> <tr> <td>R-S</td> <td>1P connection</td> </tr> </table> <p>*2 If the fixed clock is selected for the sampling method</p> <table border="1"> <tr> <td>50Hz</td> <td>Fixed clock frequency</td> </tr> </table>		Display Example	Description	3P3W2I	Wiring	1	Number of loads *1	U 150V	Voltage range	× 001.00	VT ratio	A 50A	Current range	× 001.00	CT ratio	I4 500mA	I4 current range	× 001.00	I4 CT ratio	PLL	Sampling method *2	U1 50Hz	Frequency source (Fixed clock) frequency	Interval 30 min	Interval time	R-S	1P connection
Display Example	Description																												
3P3W2I	Wiring																												
1	Number of loads *1																												
U 150V	Voltage range																												
× 001.00	VT ratio																												
A 50A	Current range																												
× 001.00	CT ratio																												
I4 500mA	I4 current range																												
× 001.00	I4 CT ratio																												
PLL	Sampling method *2																												
U1 50Hz	Frequency source (Fixed clock) frequency																												
Interval 30 min	Interval time																												
R-S	1P connection																												
50Hz	Fixed clock frequency																												
9	Function keys	This area displays items corresponding to the function keys (F1 to F5).																											

7
Measurements

7.2 Measure Screens

7.2.3 Displaying the List Screen

● Displaying the List Screen

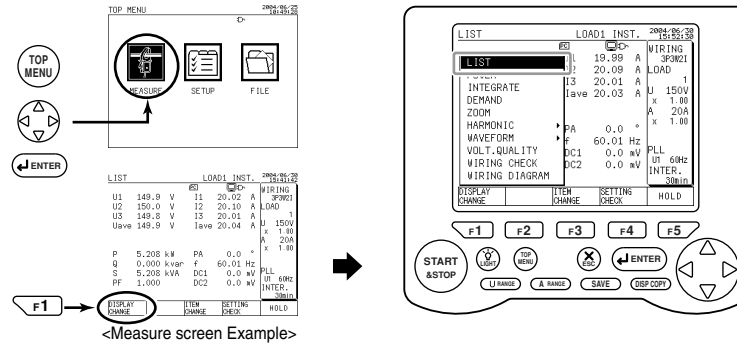

1

Selection



Using the cursor key, select LIST (highlighted).

2

Confirmation



Press the ENTER key to confirm it.

The List screen appears.

Description of the Function Keys:

F1	DISPLAY CHANGE	Switches the Measure screen.
F2	LOAD CHANGE	Switches the load to be displayed. (For multiple loads)
F3	ITEM CHANGE	Switches between instantaneous, average, maximum, and minimum values.
F4	SETTING CHECK	Displays the Setting Check screen.
F5	HOLD	Holds or cancels a displayed screen.
	HOLD/Clear	If there is integrated data, press the F5 key for more than 3 seconds to clear it as necessary.

● Description of the List Screen

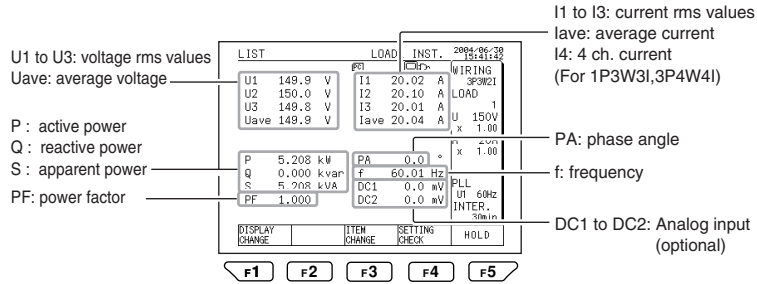

To switch the load to be displayed:

- F2** The load (measured value) changes each time the F2 key is pressed. (The display varies depending on the setting of wiring or number of loads.)

To switch the item to be displayed:

- F3** The item changes each time the F3 key is pressed:
Instantaneous value → Average → Maximum value → Minimum value

For instantaneous value measurements, the AVE, MAX., and MIN. values indicate the measured values of integration measurement conducted immediately before that. (If no integration measurement is made immediately before that, symbol ----- appears.)

NOTE

The voltage and current indications differ depending on setting of wiring.

7.2 Measure Screens

7.2.4 Displaying the Power Screen

● Displaying the Power Screen

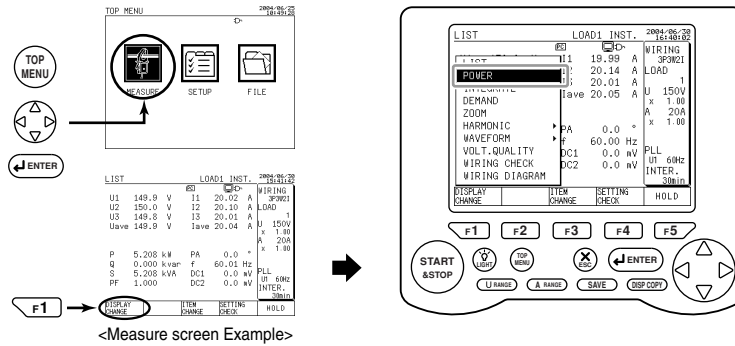

1 Selection



Using the cursor key, select POWER (highlighted).

2 Confirmation



Press the ENTER key to confirm it.

The Power screen appears.

Description of the Function Keys:

F1	DISPLAY CHANGE	Switches the Measure screen.
F2	LOAD CHANGE	Switches the load to be displayed. (For multiple loads)
F3	ITEM CHANGE	Switches between instantaneous, average, maximum, and minimum values.
F4	SETTING CHECK	Displays the Setting Check screen.
F5	HOLD	Holds or cancels a displayed screen.
	HOLD/Clear	If there is integrated data, press the F5 key for more than 3 seconds to clear it as necessary.

● Description of the Power Screen

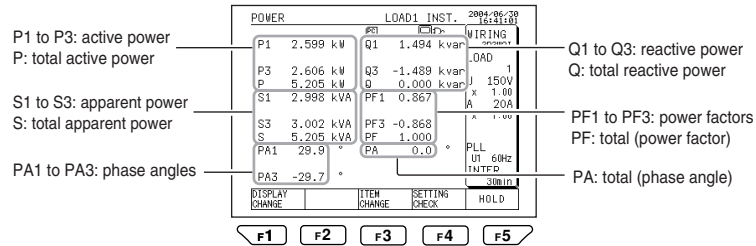

To switch the load to be displayed:

- F2** The load (measured value) changes each time the F2 key is pressed. (The display varies depending on the wiring setting or the number of loads.)

To switch the item to be displayed:

- F2** The item changes each time the F3 key is pressed:
Instantaneous value → Average → Maximum value → Minimum value

For instantaneous value measurements, the AVE, MAX., and MIN. values indicate the measured values of integration measurement conducted immediately before that. (If no integration measurement is made immediately before that, symbol ----- appears.)



NOTE

- If wiring is three-phase three-wire two-current, U3 and I2 are values obtained by vector calculation.
 - If wiring is three-phase three-wire three-current, U1, U2, and U3 are phase voltages obtained from the virtual neutral-point.
 - If wiring is three-phase four-wire or three-phase four-wire four-current, a voltage value becomes phase voltage.
 - If the reactive power meter method is not used, reactive power, power factor, and phase angle are calculated by multiplying the polarity of reactive power obtained by the reactive power meter method.
 - If wiring is three-phase three-wire two-current, or three-phase three-wire of a Scott connection, P1, P3, Q1, Q3, S1, S3, PF1, PF3, PA1, and PA3 do not have a physical meaning.
 - If wiring is three-phase three-wire three-current, active power and reactive power are results of calculations using phase voltage from the virtual neutral-point.
-

7.3 Measuring Electric Energy

● Measuring Electric Energy

In this section, you set up the start and stop times of integration to measure electric energy (integrated value) consumed during that period.

Checking settings:

To save data in integration measurement, you need to make settings.

(Start and stop times of integration, interval time during which data is saved, items to be saved, and so on)

Save 1/2 screen:

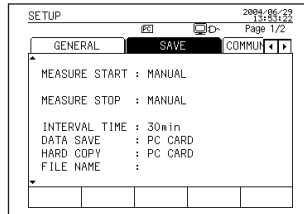

Save 2/2 screen:

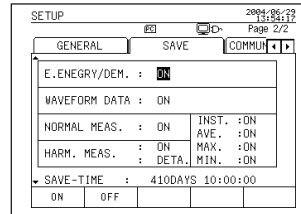

7

Measurements

SEE ALSO

For more information on settings, see Chapter 6, Configuring Settings, Section 6.4, Save Data Setting 1/2, and Section 6.5, Save Data Setting 2/2.

Set values can also be checked using the F4 key (SETTING CHECK) on the Integrate screen. If a set value needs to be changed, press the F1 key (SETUP) on the Setting Check screen.

The Setup screen appears.

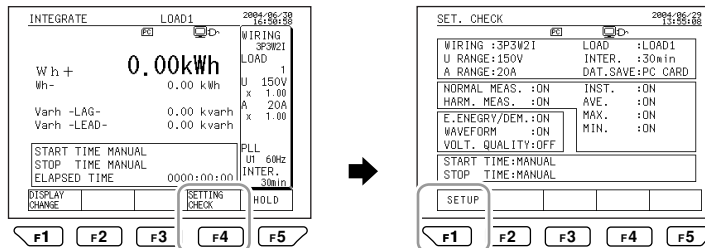

7.3 Measuring Electric Energy

● Displaying the Integrate Screen

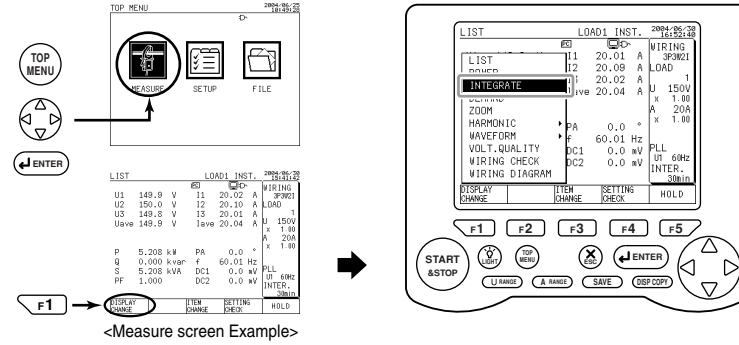

1

Selection



Using the cursor key, select INTEGRATE (highlighted).

2

Confirmation



Confirm the ENTER key to confirm it.

The Integrate screen appears.

Description of the Function Keys:

F1	DISPLAY CHANGE	Switches the Measure screen.
F2	LOAD CHANGE	Switches the load to be displayed. (For multiple loads)
F3	—	—
F4	SETTING CHECK	Displays the Setting Check screen.
F5	HOLD	Holds or cancels a displayed screen.
	HOLD/Clear	If there is integrated data, press the F5 key for more than 3 seconds to clear it as necessary.

7.3 Measuring Electric Energy

● Description of the Integrate Screen

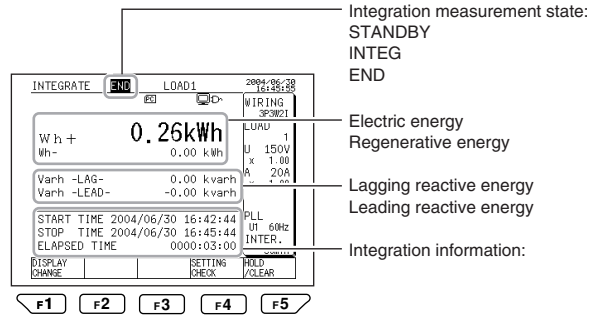

NOTE

If integration is started with the previous integrated data still remaining, an integrated value will be added to it. To make new integration, press the F5 key (HOLD/Clear) for more than 3 seconds to clear the remaining integrated data.

7.3 Measuring Electric Energy

Start of integration:



Press the START&STOP key once.

Integration is started according to the setting of the integration starting method.

Starting method : MANUAL (press the START&STOP key to start integration.)

TIME (lets you enter the date and time of start of integration) ---
Integration is on standby up to the start time.

JUST (starts integration at the optimum time) --- Integration is on
standby up to the start time.
Integration starts according to the time when the START&STOP
key is pressed and the interval time.

During integration:

When integration measurement starts, the LED lights up, indicating INTEG is being made.
Integration measured data is saved according to the data save settings.

End of integration:

Integration ends according to the setting of the integration stopping method.

Stopping method: MANUAL (press the START&STOP key to stop integration)

TIME (lets you enter the date and time of the end of integration)

TIMER (lets you set the time from the start, and integration ends when
the set time expires.)

Forced end : Even when the stopping method has been set to TIME or TIMER, you
can press the START&STOP key to stop integration.

To switch the load to be displayed:



The load changes each time the F2 key is pressed.

Measured values are displayed on a load basis.

(The display varies depending on the setting of wiring or number of loads.)

7.4 Measuring Demand

● Measuring Demand

In this section, you can set up the start and stop times of integration to measure a demand value and interval electric energy. From these, you obtain the maximum demand (power and the date and time of occurrence of it) consumed during this period.

Checking settings:

To save data in integration measurement, you need to make settings.

(Start and stop times of integration, interval time during which data is saved, items to be saved, and so on)

Save 1/2 screen:

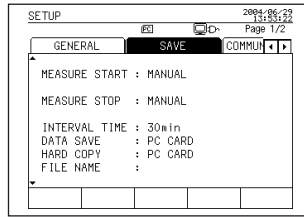

Save 2/2 screen:

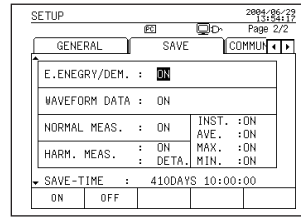

SEE ALSO

For more information on settings, see Chapter 6, Configuring Settings, Section 6.4, Save Data Settings 1/2, and Section 6.5, Save Data Settings 2/2.

Set values can also be checked using the F4 key (SETTING CHECK) on the Integrate screen. If a set value needs to be changed, press the F1 key (SETUP) on the Setting Check screen. The Setup screen appears.

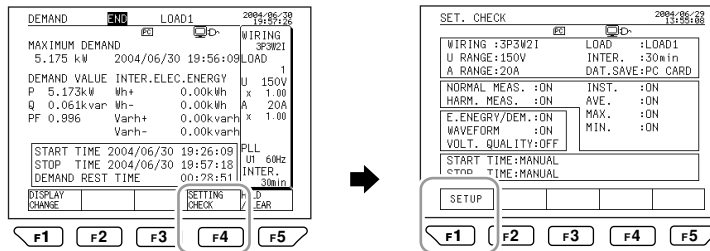

7.4 Measuring Demand

● Displaying the Demand Screen

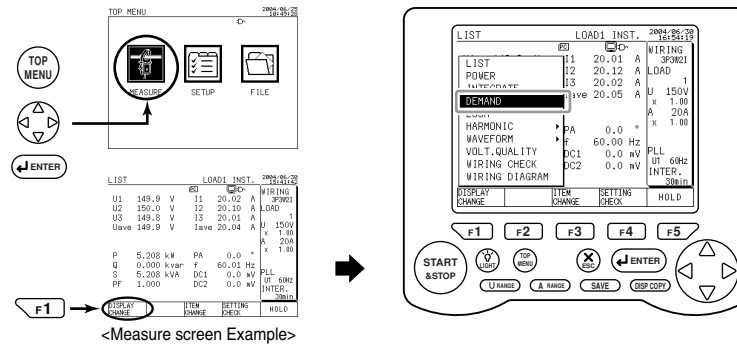

1 Selection



Using the cursor key, select DEMAND (highlighted).

2 Confirmation



Press the ENTER key to confirm it.

The Demand screen appears.

Description of the Function Keys:

F1	DISPLAY CHANGE	Switches the Measure screen.
F2	LOAD CHANGE	Switches the load to be displayed. (For multiple loads)
F3	—	—
F4	SETTING CHECK	Displays the Setting Check screen.
F5	HOLD	Holds or cancels a displayed screen.
	HOLD	If there is integrated data, press the F5 key for more than 3 seconds to clear it as necessary.

● Description of the Demand Screen (Items to be Measured)

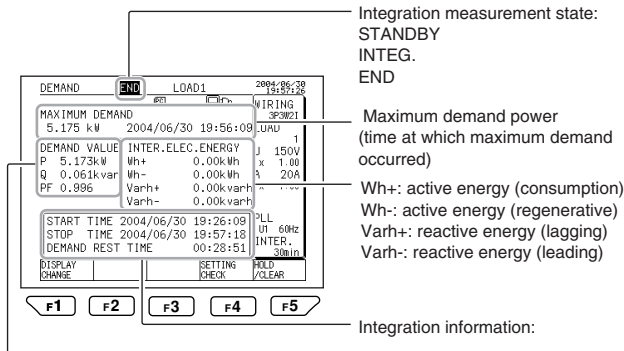

P: active power (consumption)
 Q: reactive power (lagging)
 PF: power factor

NOTE

If the previous integration measured data remains, the maximum demand value is continued. To reset the maximum demand value, press the F5 key (HOLD/Clear) for more than 3 seconds to clear the integrated data as necessary.

7.4 Measuring Demand

Start of integration:



Press the START&STOP key once.

Integration is started according to the setting of the integration starting method.

Starting method : MANUAL (press the START&STOP key to start integration.)

TIME (lets you enter the date and time of start of integration) ---
Integration is on standby up to the start time.

JUST (starts integration at the optimum time) --- Integration is on
standby up to the start time.
Integration starts according to the time when the START&STOP
key is pressed and the interval time.

During integration:

When integration measurement starts, the LED lights up, indicating INTEG is being made.
Integration measured data is saved according to the data save settings.

End of integration:

Integration ends according to the setting of the integration stopping method.

Stopping method: MANUAL (press the START&STOP key to stop integration)

TIME (lets you enter the date and time of the end of integration)

TIMER (lets you set the time from the start, and integration ends when
the set time expires.)

Forced end : Even when the stopping method has been set to TIME or TIMER, you
can press the START&STOP key to stop integration.

To switch the load to be displayed:



The load changes each time the F2 key is pressed.

Measured values are displayed on a load basis.

(The display varies depending on the setting of wiring or number of loads.)

7.5 Displaying Zoom (Expanded View)

● Displaying the Zoom Screen

In this section, you can zoom five measured values.

(Items that can be zoomed are only instantaneous values for normal measurement data and measured data for electric energy.)

ZOOM		LOAD1	2004-06-28 16:59:02
1 →	V	149.9	V
2 →	I1	20.01	A
3 →	P	5.205	kW
4 →	Q	0.000	kvar
5 →	S	5.205	kVA

DISPLAY CHANGE	ITEM CHANGE	SETTING CHECK	HOLD
----------------	-------------	---------------	------

Five measured values can be zoomed.

7.5 Displaying Zoom (Expanded View)

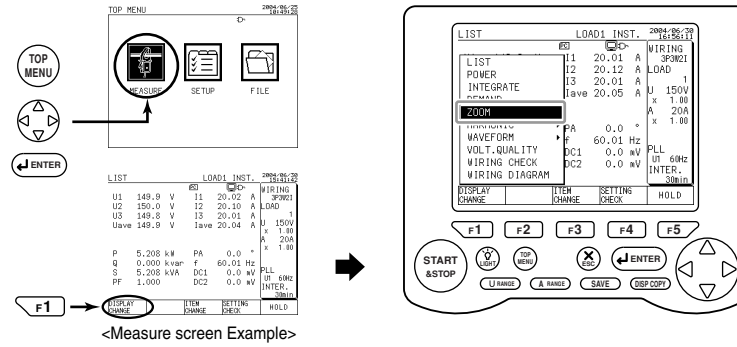

1

Selection



Using the cursor key, select **ZOOM** (highlighted).

The Zoom screen appears.

2

Confirmation



Press the **ENTER** key to confirm it.

Description of the Function Keys:

F1	DISPLAY CHANGE	Switches the Measure screen.
F2	LOAD CHANGE	Switches the load to be displayed. (For multiple loads)
F3	ITEM CHANGE	Changes the item to be measured that is zoomed.
F4	ITEM CHANGE	Displays the Setting Check screen.
F5	HOLD	Holds or cancels a displayed screen.
	HOLD/Clear	If there is integrated data, press the F5 key for more than 3 seconds to clear it as necessary.

7.5 Displaying Zoom (Expanded View)

● Switching the Item to be Displayed

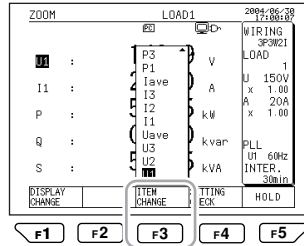

1 Selecting the display area



Using the cursor key, select the display area to be changed (highlighted).

2 Displaying the window



Press the F3 key (ITEM CHANGE).

The window showing the items appears.

Example of display:

```
P
I2
I1
U2
U1
```

3 Selecting the item



Using the cursor key, select the item to be displayed (highlighted).

If you do not change the setting, press the ESC key. The window returns to the Zoom screen.

4 Confirmation



Press the ENTER key.

This closes the window, returning you to the Zoom screen.

To switch the load to be displayed:



The load changes each time the F2 key is pressed.

Measured values are displayed on a load basis.

(The display varies depending on the wiring setting or the number of loads.)

7

Measurements

7.6 Measuring Harmonics

Harmonic measurements (analysis of 1st to 50th harmonics) can be displayed in any of three screens: List, Graph, and Vector.

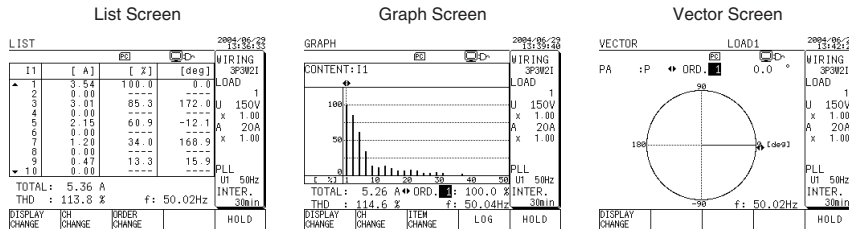

● Items to be Measured

Elements to be Measured	Items to be Measured (Analyzed)		
Voltage U1, U2, and U3	Level [V] rms value	Content (%)	Phase angle [deg]
Current I1, I2, I3, and I4	Level [A] rms value	Content (%)	Phase angle [deg]
Power P	Level [W] Power value	Power content (%)	Power phase angle [deg]

The unit of phase angle, degree [deg], is an angle (°).

Level : harmonic level at each order

Content : the percentage of harmonic component with the fundamental wave regarded as 100%

Phase angle: phase angle with respect to the reference set by a phase angle calculation method

Items to be Measured (Analyzed)	Description		
TOTAL	For voltage: Total rms value [V]	For current: Total rms value [A]	For power: Total power value [W]
THD Total Harmonic Distortion	THD is set using the THP MEASURE METHOD on the General 2/2 screen. Select either the fundamental wave base or total base.		
f	Frequency of fundamental wave (frequency source) [Hz]		

● Displaying the Harmonic Screen

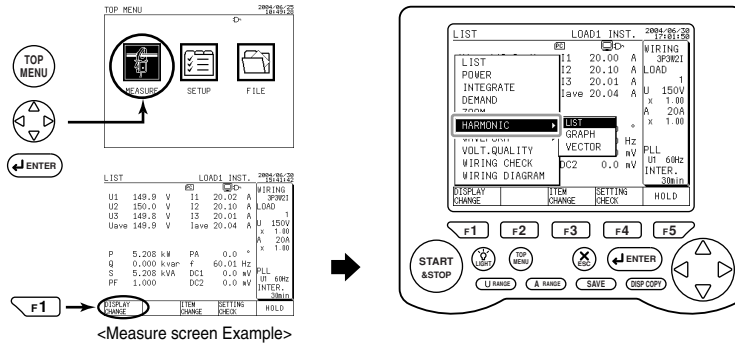

<Measure screen Example>

1 Displaying the window



Press the F1 key (DISPLAY CHANGE).

The window for switching the screen appears.

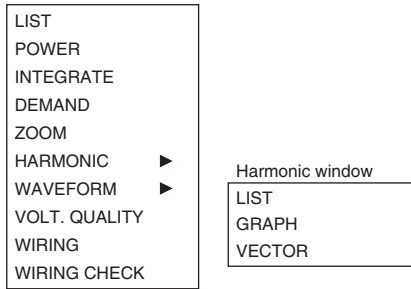

2 Selection and Confirmation



Using the cursor key, select HARMONIC (highlighted).

Press the right direction cursor key to move to the Harmonic window.

Select one of LIST, GRAPH, and VECTOR using the up and down direction cursor key.



Press the ENTER key.

This closes the window, returning you to the selected screen.

7.6 Measuring Harmonics

7.6.1 Displaying a List

● Displaying the List Screen

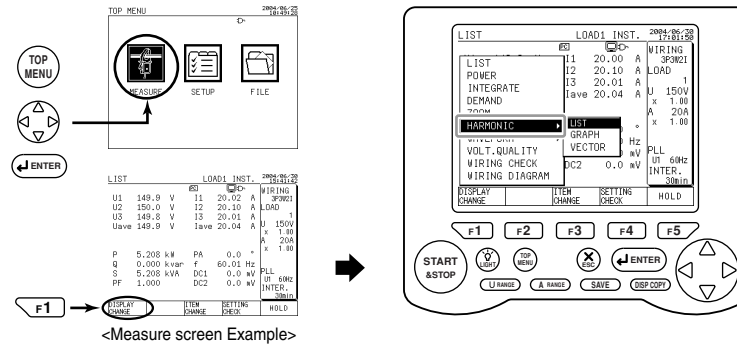

1 Displaying the Measure screen

F1 Press the F1 key (DISPLAY CHANGE).
The window for switching the screen appears.

2 Selecting a list

Using the cursor key, select HARMONIC (highlighted).
Press the right direction cursor key to move to the Harmonic window.
Select LIST (highlighted) using the up and down direction cursor key.

3 Confirmation

ENTER Press the ENTER key.
The List screen appears.

Description of the Function Keys:

F1	DISPLAY CHANGE	Switches the Measure screen.
F2	CH CHANGE	Switches the element to be measured.
F3	ORDER CHANGE	Switches the order of harmonic to be displayed. ALL ORD. (1st to 50th)/ODD ORD.
F4	—	—
F5	HOLD	Holds or cancels a displayed screen.
	HOLD/Clear	If there is integrated data, press the F5 key for more than 3 seconds to clear it as necessary.

● Description of the List Screen

Display information:

Element	Level	Content	Phase angle
1	3.54	100.0	0.0
2	0.00	---	---
3	3.01	85.3	172.0
4	0.00	---	---
5	2.15	60.9	-12.1
6	0.00	---	---
7	1.20	34.0	168.9
8	0.00	---	---
9	0.47	13.3	15.9
0	0.00	---	---

TOTAL: 5.36 A
 THD : 113.8 %
 f: 50.02Hz

Annotations:
 - Element to be measured: points to the 'Element' column header.
 - Page (order) change: points to the '11' in the first row.
 - TOTAL: total rms value (Element to be measured, P: total power value): points to the 'TOTAL' summary line.

TOTAL: total rms value
 (Element to be measured,
 P: total power value)
 THD: total harmonic distortion
 f: Frequency

Element to be Measured	Items to be Measured			
Voltage U1, U2, and U3	Level [V] rms value	Content [%]	Phase angle [deg]	TOTAL [V] Total rms value
Current I1, I2, I3, and I4	Level [A] rms value	Content [%]	Phase angle [deg]	TOTAL [A] Total rms value
Power P	Level [W] Power value	Power Content [%]	Power phase angle [deg]	TOTAL [W] Total power value

The unit of phase angle, degree [deg], is angle (°).

7.6 Measuring Harmonics

Display information:

Element to be measured

Level Content Phase angle

Element to be measured	Level	Content	Phase angle
1	3.54	100.0	0.0
2	0.00	---	---
3	3.01	85.3	172.0
4	0.00	---	---
5	2.15	60.9	-12.1
6	0.00	---	---
7	1.20	34.0	168.9
8	0.00	---	---
9	0.47	13.3	15.9
0	0.00	---	---

TOTAL: 5.36 A
THD : 113.9 %
f: 50.02Hz

Legend:
TOTAL: total rms value (Element to be measured)
P: total power value
THD: total harmonic distortion
f: Frequency

To switch the page:



Using the up and down direction cursor key, switch the page to be displayed.

The page configuration differs depending on the setting of F3 (ORDER CHANGE).

All Orders		Odd-number Orders	
Page	Orders	Page	Orders
1	1 to 10	1	1,3,5,7,9,11,13,15,17,19
2	11 to 20	2	21,23,25,27,29,31,33,35,37,39
3	21 to 30	3	41,43,45,47,49
4	31 to 40	—	—
5	41 to 50	—	—

To change the channel:

1 **Displaying the window**



Press the F2 key.

The window for selecting the channel appears.
(The display differs depending on the setting of wiring.)

Example of wiring: 1P3W

P
I2
I1
U2
U1

2 **Selection**



Using the cursor key, select CH to be displayed (highlighted).

If you do not change the setting, press the ESC key. The window returns to the List screen.

3 **Confirmation**



Press the ENTER key.

This closes the window, returning you to the List screen.

Display of the Window According to Wiring Setting

Wiring	1P2W	1P3W	1P3W3I	3P3W2I	3P4W4I	3P3W+1P3W	
				3P3W3I			
				3P4W			
Elements	U1	U1	U1	U1	U1	U1_3P	I1_3P
	I1	U2	U2	U2	U2	U2_3P	I2_3P
	P	I1	I1	U3	U3	U3_3P	I3_3P
		I2	I2	I1	I1	U1_1P	I1_1P
		P	I4	I2	I2	U2_1P	I2_1P
			P	I3	I3		P_3P
				P	I4		P_1P
					P		

For multiple loads, A number representing load(s) is appended following element.

Example: LOAD1 I1_1
LOAD2 I1_2

7.6 Measuring Harmonics

7.6.2 Displaying a Graph

● Displaying the Graph Screen

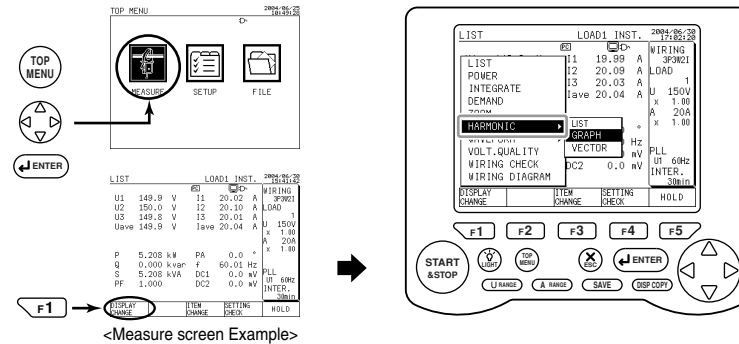

1 Displaying the Measure screen



Press the F1 key (SCREEN CHANGE).

The window for switching the screen appears.

2 Selecting a graph



Using the cursor key, select HARMONIC (highlighted).

Press the right direction cursor key to move to the Harmonic window.

Using the up and down direction cursor key, select GRAPH (highlighted).

3 Confirmation



Press the ENTER key.

The Graph screen appears.

Description of the Function Keys:

F1	DISPLAY CHANGE	Switches the Measure screen.
F2	CH CHANGE	Switches the element to be measured.*
F3	ITEM CHANGE	Switches between LEVEL, CONTENT, and PHASE ANGLE.
F4	LINEAR/LOG	Switches between LEVEL, CONTENT, and PHASE ANGLE.
F5	HOLD	Holds or cancels a displayed screen.
	HOLD/Clear	If there is integrated data, press the F5 key for more than 3 seconds to clear it as necessary.

*: For more information on F2(CH CHANGE), see 7.6.1 Displaying a List.

● Description of the Graph Screen

Display information:

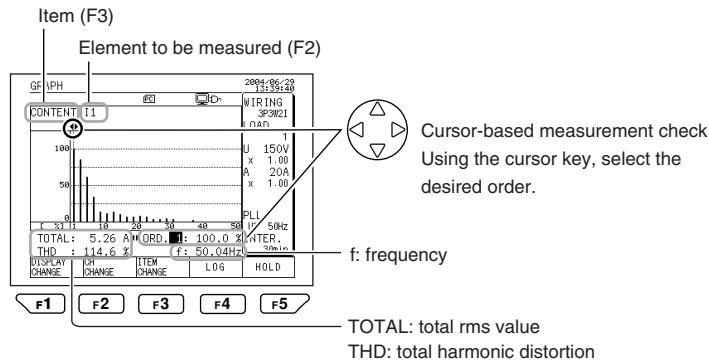

Cursor-based measurement check:



Using the right and left direction cursor key, move the cursor indication in the graph to select the desired order. This allows you to view the measured value of the selected order.

To change the item:

1

Displaying the window



Press the F3 key.

The window for selecting an item appears.



2

Selection



Using the cursor key, select a desired item (highlighted).

If you do not change the setting, press the ESC key. The window returns to the List screen.

3

Confirmation



Press the ENTER key.

The Graph screen appears.

To change the vertical axis:



Each time the F4 key is pressed, the following items are selected alternately:

Linear and Log

7.6 Measuring Harmonics

7.6.3 Displaying a Vector

● Displaying the Vector Screen

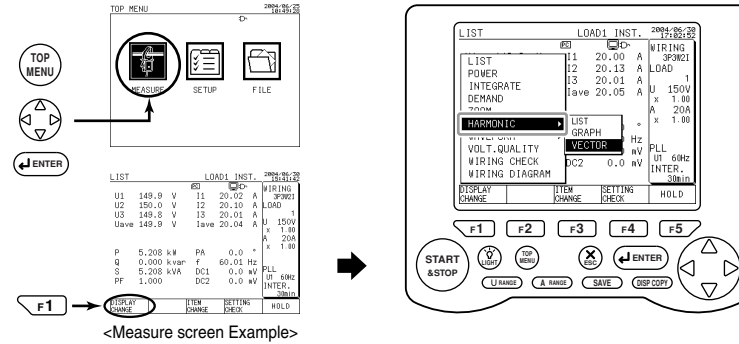

1 Displaying the Measure screen



Press the F1 key (DISPLAY CHANGE).

The window for switching the screen appears.

2 Selecting a vector



Using the cursor key, select HARMONIC (highlighted).

Press the right direction cursor key to move to the Harmonic window.

Using the up and down direction cursor key, select VECTOR (highlighted).

3 Confirmation



Press the ENTER key to confirm it.

The VECTOR screen appears.

Description of the Function Keys:

F1	DISPLAY CHANGE	Switches the Measure screen.
F2	LOAD CHANGE	Switches the load to be displayed. (For multiple loads)
F3	—	—
F4	—	—
F5	HOLD	Holds or cancels a displayed screen.
	HOLD/Clear	If there is integrated data, press the F5 key for more than 3 seconds to clear it as necessary.

● Description of the Vector Screen

Display information:

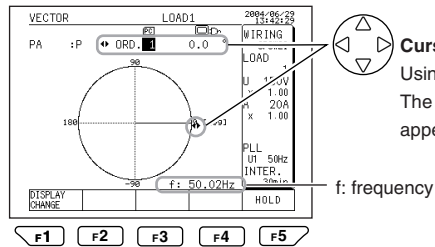

Cursor-based measurement check
Using the cursor key, select the desired order.
The measured value of the selected order appears.

f: frequency

Vector length: Represents apparent power (S).

It indicates the apparent power of each order with the apparent power of the fundamental wave regarded as 100%.

Axes: The horizontal axis shows active power, while the vertical axis shows reactive power. (LOG axis)

Cursor-based measurement check:



Using the right and left direction cursor key, move the cursor indication in the vector diagram to select the order. This allows you to view the measured value of the selected order.

To change load:



Each time the F2 key is pressed, the following items are selected in turn:

Example: in the case of LOAD 3
LOAD 1 → LOAD 2 → LOAD 3

7.7 Displaying Waveform

In this section, you display one wave of voltage and/or current. It can be displayed in one of three screens: U&I WAVEFORM, U WAVEFORM, and I WAVEFORM.

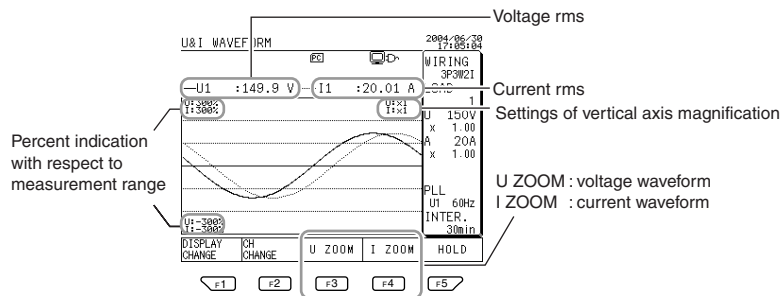
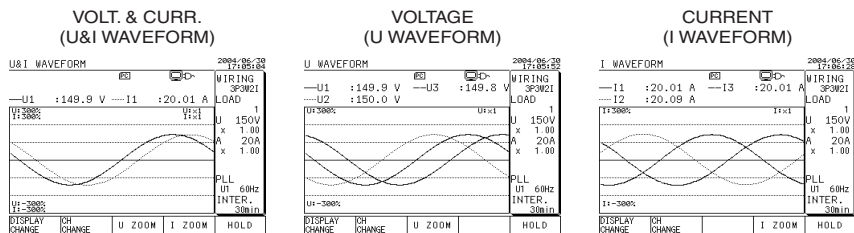

Vertical axis:

The display range of the vertical axis is determined on the basis of the measurement range set.

For voltage waveform: Set using the **F3** key (U ZOOM).

For current waveform: Set using the **F4** key (I ZOOM).

CH change:

Press the F2 key(CH CHANGE), changes the waveform of the voltage or current to be displayed and the measured value (rms).

● Displaying the Waveform Screen

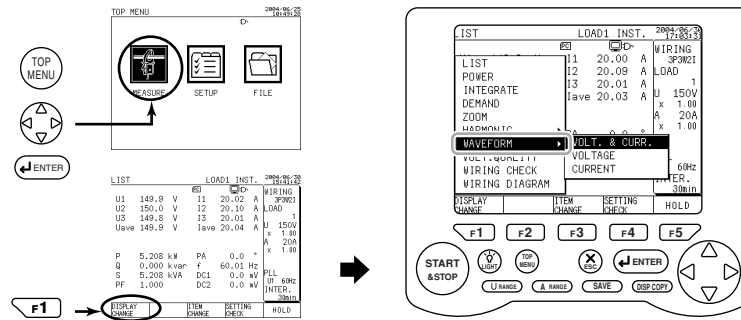

1 Displaying the Measure screen

F1 Press the F1 key (DISPLAY CHANGE).
The window for switching the screen appears.

2 Selecting waveform

Using the cursor key, select WAVEFORM (highlighted).
Press the right direction cursor key to move to the Waveform window.
Using the up and down direction cursor key, select the desired waveform (highlighted).
(Select one of VOLT. & CURR., VOLTAGE, and CURRENT.)

3 Confirmation

ENTER Press the ENTER key to confirm it.

7.7 Displaying Waveform

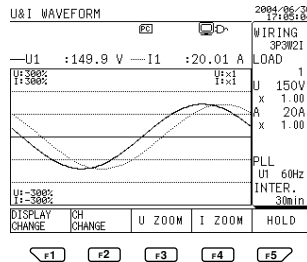

Description of the Function Keys:

F1	DISPLAY CHANGE	Switches the Measure screen. LIST, POWER, INTEGRATE, DEMAND, ZOOM, WAVEFORM, VOLT. QUALITY, WIRING, and WIRING CHECK
F2	CH CHANGE	Switches the element to be measured that is displayed.
F3	U ZOOM *1	Switches the value of the vertical axis of voltage.
F4	I ZOOM *1	Switches the value of the vertical axis of current.
F5	HOLD	Holds or cancels a displayed screen.
	HOLD/Clear	If there is integrated data, press the F5 key for more than 3 seconds to clear it as necessary.

*1: For U&I WAVEFORM, both the F3 and F4 are indicated.
For U WAVEFORM, only the F3 (U ZOOM) is indicated.
For I WAVEFORM, only the F4 (I ZOOM) is indicated.

U ZOOM:

U ZOOM allows you to change the magnification (scaling) of the vertical axis of voltage.



Each time the F3 key is pressed, magnification changes:

1 → 2 → 5 → 10 → 20 → 1/3 → 1/2

I ZOOM:

I ZOOM allows you to change the magnification (scaling) of the vertical axis of current.



Each time the F4 key is pressed, magnification changes:

1 → 2 → 5 → 10 → 20 → 1/3 → 1/2

To switch a waveform screen:



Using the up and down direction cursor key, switch the waveform screen.

Each time the Δ cursor key is pressed, the waveform screen change as follows:

U&I WAVEFORM → U WAVEFORM → I WAVEFORM

Each time the ∇ cursor key is pressed, the waveform screen changes as follows:

U&I WAVEFORM → I WAVEFORM → U WAVEFORM

7.7 Displaying Waveform

To switch U&I WAVEFORM - CH:

F2

Each time the F2 key is pressed, the element to be measured is switched.

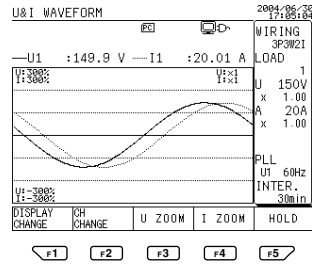

Switching of the elements to be measured differs depending on wiring.

Wiring		CH Change
1P2W	One load	U1, I1
	Two loads	U1, I1_1 → U1, I1_2 → U1, I1_1
	Three loads	U1, I1_1 → U1, I1_2 → U1, I1_3 → U1, I1_1
	Four loads	U1, I1_1 → U1, I1_2 → U1, I1_3 → U1, I1_4 → U1, I1_1
1P3W	One load	U1, I1 → U2, I2 → U1, I1
	Two loads	U1, I1_1 → U2, I2_1 → U1, I1_2 → U2, I2_2 → U1, I1_1
1P3W3I		U1, I1 → U2, I2 → I4 → U1, I1
3P3W2I	One load	U1, I1 → U2, I2 → U3, I3 → U1, I1
	Two loads	U1, I1_1 → U2, I2_1 → U3, I3_1 → U1, I1_2 → U2, I2_2 → U3, I3_2 → U1, I1_1
3P3W3I 3P4W		U1, I1 → U2, I2 → U3, I3 → U1, I1
3P4W4I		U1, I1 → U2, I2 → U3, I3 → I4 → U1, I1
3P3W+1P3W		U1_3P, I1_3P → U2_3P, I2_3P → U3_3P, I3_3P → U1_1P, I1_1P → U2_1P, I2_1P → U1, I1_1

7

Measurements

7.7 Displaying Waveform

To switch U WAVEFORM - CH:

F2

Each time the F2 key is pressed, the element to be measured is switched.

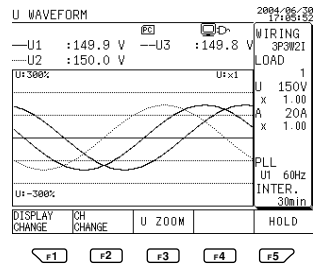

Switching of the elements to be measured differs depending on wiring.

Wiring	CH Change
1P2W	U1
1P3W 1P3W3I	U1 → U2 → U1, U2 → U1
3P3W2I 3P3W3I 3P4W 3P4W4I	U1 → U2 → U3 → U1, U2, U3 → U1
3P3W+1P3W	U1_3P → U2_3P → U3_3P → U1_3P, U2_3P, U3_3P → U1_1P → U2_1P → U1_1P, U2_1P → U1_3P

7.7 Displaying Waveform

To switch I WAVEFORM - CH:

F2

Each time the F2 key is pressed, the element to be measured is switched.

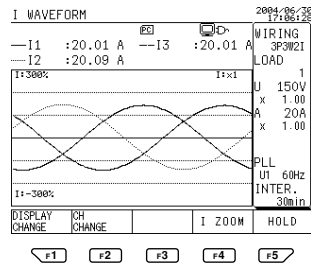

Switching of the elements to be measured differs depending on wiring.

Wiring		CH Change
1P2W	One load	I1
	Two loads	I1_1 → I1_2 I1_1
	Three loads	I1_1 → I1_2 → I1_3 → I1_1
	Four loads	I1_1 → I1_2 → I1_3 → I1_4 → I1_1
1P3W	One load	I1 → I2 → I1, I2 → I1
	Two loads	I1_1 → I2_1 → I1_1, I2_1 → I1_2 → I2_2 → I1_2 → I2_2 → I1_1
1P3W3I		I1 → I2 → I4 → I1, I2, I4 → I1
3P3W2I	One load	I1 → I2 → I3 → I1, I2, I3 → I1
	Two loads	I1_1 → I2_1 → I3_1 → I1_1, I2_1, I3_1 → I1_2 → I2_2 → I3_2 → I1_2, I2_2, I3_2 → I1_1
3P3W3I		I1 → I2 → I3 → I1, I2, I3 → I1
3P4W		I1 → I2 → I3 → I4 → I1, I2, I3, I4 → I1
3P4W4I		I1 → I2 → I3 → I4 → I1, I2, I3, I4 → I1
3P3W+1P3W		I1_3P → I2_3P → I3_3P → I1_3P, I2_3P, I3_3P → I1_1P → I2_1P → I1_1P, I2_1P → I1_3P

7

Measurements

7.8 Measuring Voltage Quality (Voltage Dip, Voltage Swell, or Instantaneous Interruption)

In this section, three items of voltage quality are measured and displayed. The date and time of the occurrence of the item under test and other information are displayed (detected/measured).

Voltage Quality (Voltage Fluctuation)	Setting Range (with Respect to Standard Voltage)
Voltage swell (Swe)	0 to 200%
Voltage dip (Dip)	0 to 100%
Instantaneous voltage interruption (Int)	0 to 100%
Hysteresis common to the three items can also be set.	0 to 10%

Date Time Item Channel (element to be measured)

VOL T. QUAL ITM CH IO RMS Period

2004/06/29 Voltage (rms)

Date	Time	Itm	CH	IO	RMS	Period
06/29	3:48:46.096	Dip	3	I	0.0 V	00:00:00.000
06/29	3:48:46.096	Int	3	I	0.0 V	00:00:00.000
06/29	3:48:49.435	Swe	1	I	103.1 V	00:00:00.000
06/29	3:48:49.435	Swe	2	I	103.1 V	00:00:00.000
06/29	3:48:53.416	Swe	1	O	11.0 V	00:00:03.979
06/29	3:48:53.416	Dip	1	I	11.0 V	00:00:00.000
06/29	3:48:53.416	Dip	2	O	11.0 V	00:00:03.979
06/29	3:48:53.416	Dip	2	I	11.0 V	00:00:00.000
06/29	3:48:53.436	Int	1	I	0.0 V	00:00:00.000
06/29	3:48:53.436	Int	2	I	0.0 V	00:00:00.000
06/29	3:48:55.095	Int	1	O	42.3 V	00:00:01.661
06/29	3:48:55.095	Int	2	O	42.3 V	00:00:01.661
06/29	3:48:55.115	Dip	1	O	102.5 V	00:00:01.701

— Period of occurrence of the item under test

DISPLAY CHANGE ITEM CHANGE SAVE HOLD /CLEAR

● Display Items

Display Items	Description
Date	Indicates the detection date in MM/DD.
Time	Indicates the detection time in hh:mm:ss.nnn.
Itm	Shows the items detected. Swe : voltage swell Dip : voltage dip Int : instantaneous voltage interruption
CH	Shows the channel under test. (If wiring is a Scott connection, _1P or _3P is assigned.)
IO	Indicates the occurrence of an item under test and end of detection. I : occurrence of an item under test O : end of detection
RMS	Shows the voltage rms of an item under test when it has been detected.
Period	Indicates the period between the detection of an item under test and the end of detection. hh : mm : ss.nnn

SEE ALSO

For more information on voltage quality, see Section 6.7, Voltage Quality Settings.

7.8 Measuring Voltage Quality (Voltage Dip, Voltage Swell, or Instantaneous Interruption)

● Displaying the Volt. Quality Screen

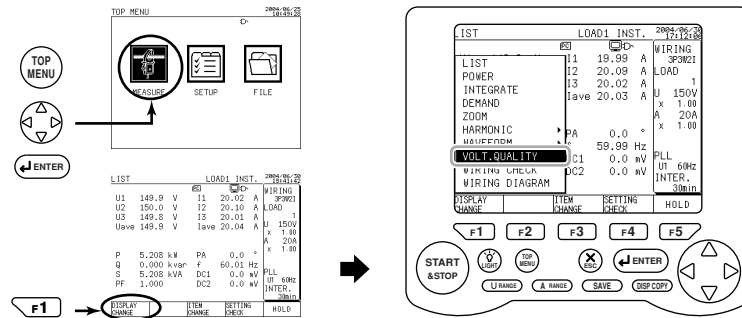

1 Displaying the Measure screen



Press the F1 key (DISPLAY CHANGE).

The window for switching the screen appears.

2 Selecting voltage quality



Using the cursor key, select VOLT. QUALITY (highlighted).

3 Confirmation



Press the ENTER key to confirm it.

The Volt. Quality screen appears.

Description of the Function Keys:

F1	DISPLAY CHANGE	Switches the Measure screen.
F2	ITEM CHANGE	Switches the item under test. ALL, SWELL, DIP, and INST.
F3	SAVE	Lets you manually save/print measured data.
F4	–	–
F5	HOLD	Holds or cancels a displayed screen.
	HOLD/Clear	If there is integrated data, press the F5 key for more than 3 seconds to clear it as necessary.

7.8 Measuring Voltage Quality (Voltage Dip, Voltage Swell, or Instantaneous Interruption)

Use the cursor key to scroll the cursor indication.

Date	Time	Item	CH	IO	RMS	Period
06/29	13:48:46	Dip	3	1	0.0	V:00:00:00.000
06/29	13:48:46	Int	3	1	0.0	V:00:00:00.000
06/29	13:48:49	Swe	1	1	103.1	V:00:00:00.000
06/29	13:48:49	Swe	2	1	103.1	V:00:00:00.000
06/29	13:48:53	Swe	1	0	11.0	V:00:00:03.979
06/29	13:48:53	Dip	1	1	11.0	V:00:00:00.000
06/29	13:48:53	Swe	2	0	11.0	V:00:00:03.979
06/29	13:48:53	Dip	2	1	11.0	V:00:00:00.000
06/29	13:48:53	Int	1	1	0.0	V:00:00:00.000
06/29	13:48:53	Int	2	1	0.0	V:00:00:00.000
06/29	13:48:55	Int	1	0	42.3	V:00:00:01.661
06/29	13:48:55	Int	2	0	42.3	V:00:00:01.661
06/29	13:48:55	Dip	1	0	102.5	V:00:00:01.701

DISPLAY CHANGE ITEM CHANGE SAVE HOLD /CLEAR
 F1 F2 F3 F4 F5

To save data manually:



Press the F3 (SAVE) key.

The voltage quality measurement data is saved to DATA SAVE.

If RS-232 CONNECT has been set to PRINTER, printout is carried out at the same time data saving.

To change the item:



Each time the F4 key is pressed, the item changes as follows:

ALL → SWELL → DIP → INST.

To scroll the screen:



Press the up and down direction cursor key to scroll the screen.

△: Up cursor key that scrolls the screen one page forward.

▽: Down cursor key that scrolls the screen one page backward.



NOTE

- The up and down direction cursor key can be used only when the number of the items detected exceeds 13. (In this case, the up and down arrow marks are indicated on the left edge of the screen.)
- The maximum number of the items detected that can be recorded by the CW240 is 100. If it exceeds 100, the newest item overwrites the oldest.
- Voltage quality measured data cannot be saved or printed out using the SAVE key (direct key).

7.9 Checking Settings

It is recommended that the setting conditions (set values) be checked before starting a measurement. Setting checks can be made on any of the following Measure screens (using the F4 key).

LIST, POWER, INTEGRATE, DEMAND, and ZOOM

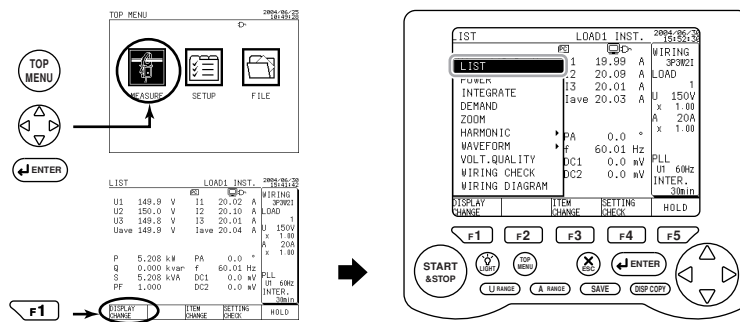

This section describes the setting check procedure taking the List screen as an example.

1 Displaying a Setting Check screen

F4 Press the F4 key.

The setting information is displayed.

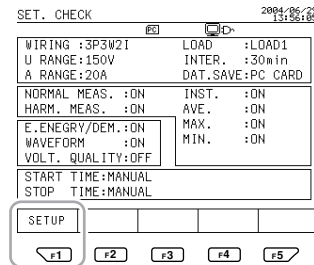

2 Checking the setting information

Check if settings are correct.

The selective items of the settings required are contained in the setting check sheet in the "Quick setup Manual". It may be useful in grasping the setting conditions and making accurate settings in the field without wasting time.

7.9 Checking Settings

End:

If no setting change is required	To change setting
Press the ESC key. This returns to the Measure screen.	Press the F1 key. The Setup screen appears.

● Changing Settings

1 Change



Press the F1 key.

The Setup screen appears. Change the necessary item(s).

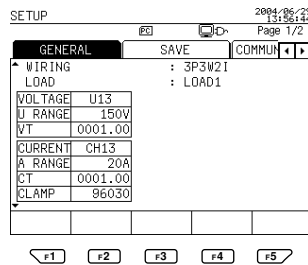

2 Setting

For the setting procedure (details), see Chapter 6, Configuring Settings.

End:

Press the ENTER key.

This returns to the Measure screen.

NOTE

- During integration measurement (including being on standby), only the following setting items can be changed:
LANGUAGE, BEEP, BACKLIGHT AUTO OFF, and LCD CONTRAST
- If integrated data has not been cleared, only the following setting items can be changed:
MEASURE START (date and time), MEASURE STOP (date and time), LANGUAGE, BEEP, BACKLIGHT AUTO OFF, and LCD CONTRAST
To change other items, you must first clear the integrated data.

7.10 Clearing Integrated Data

To conduct new integration measurements or change a set value after completing an integration measurement, you need to clear the integrated data (integrated values) stored in the CW240. To clear integrated data (with the exception of wiring diagrams), press the F5 key on a Measure screen.

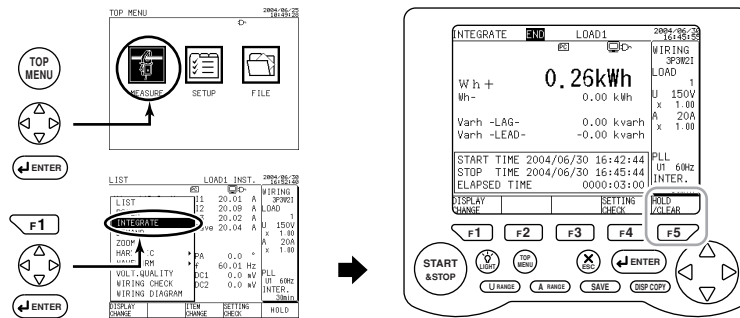

This section describes the integrated data-clearing procedure taking the Integrate screen as an example.

1 Check

If integrated data has been saved in the CW240, the F5 key function indication shows HOLD/Clear.

(If no integrated data has been saved, the F5 shows HOLD only.)

2 Clear

F5

Press the F5 key for more than 3 seconds.

A message asking if you want to clear integrated data appears.

(When a clear is completed, the F5 display item changes to "HOLD.")

TIP

- When showing HOLD only, the F5 key alternately selects HOLD and CANCEL each time it is pressed.
- If you cannot change the setting conditions (set values), check if the previous integrated data is still saved and if so, clear it.

7.11 Measurement Data

7.11.1 Instantaneous Value Measurement

Normal measurement data

Measurement Function	Instantaneous Values			
	Each Phase/CH	Inter-phase Average	Σ	Each Load
Voltage rms value	○	○	—	—
Current rms value	○	○	—	○
Active power	○	—	○	○
Reactive power	○	—	○	○
Apparent power	○	—	○	○
Power factor	○	○	—	○
Phase angle	○	○	—	○
Frequency	○	—	—	—
DC voltage (option)	○	—	—	—

Legend ○ : measured data available — : measured data not available

Harmonic measurement data

Measurement Function		Instantaneous Values				
		Each Phase	Σ	Each Load	Selected Order *1	All Orders *2
Voltage rms value	*1	○	—	—	○	○
Voltage content		○	—	—	○	—
Voltage phase angle		○	—	—	○	—
Current rms value		○	—	○	○	○
Current content		○	—	○	○	—
Current phase angle		○	—	○	○	—
Power value		—	○	○	○	○
Power content		—	○	○	○	—
Power phase angle		—	○	○	○	—
Voltage THD		○	—	—	—	○
Current THD		○	—	○	—	○

Legend ○ : measured data available — : measured data not available

*1: Numerical data of any of the 1st to 50th.

*2: All orders means numerical data of all objective waveforms including the fundamental wave and all harmonics.

TIP

- Each phase/CH: indicates that measured data is available for each phase or each channel.
- Inter-phase average: represents the average of each phase of voltage, current, power factor, and phase angle.
- Σ : represents the total of each phase of active power, reactive power, and apparent power.
- f (frequency): shows the measured frequency of a signal selected for the frequency source.

7.11.2 Integration Measurements

Normal measurement data

Measurement Function	Instantaneous Values			
	Each Phase/CH	Inter-phase Average	Σ	Each Load
Voltage rms value	○	○	—	—
Current rms value	○	○	—	○
Active power	○	—	○	○
Reactive power	○	—	○	○
Apparent power	○	—	○	○
Power factor	○	○	—	○
Phase angle	○	○	—	○
Frequency	○	—	—	—
DC voltage (option)	○	—	—	—

Legend ○ : measured data available — : measured data not available

7.11 Measurement Data

Electric energy and demand measurement data

Measurement Function	Integrated Value/Demand Value	
	Σ	Each Load
Electric energy consumed	○	○
Regenerative energy	○	○
Lagging reactive energy	○	○
Leading reactive energy	○	○
Interval electric energy consumed	○	○
Interval regenerative energy	○	○
Interval lagging reactive energy	○	○
Interval leading reactive energy	○	○
Power consumption demand	○	○
Lagging reactive power demand	○	○
Power factor demand	○	○
Maximum demand	○	○
Date and time of occurrence of maximum demand	○	○

Legend ○ : measured data available — : measured data not available

Harmonic measurement data

Measurement Function	Instantaneous Values				
	Each Phase	Σ	Each Load	Selected Order *1	All Orders *2
Voltage rms value	○	—	—	○	○
Voltage content	○	—	—	○	—
Voltage phase angle	○	—	—	○	—
Current rms value	○	—	○	○	○
Current content	○	—	○	○	—
Current phase angle	○	—	○	○	—
Power value	—	○	○	○	○
Power content	—	○	○	○	—
Power phase angle	—	○	○	○	—
Voltage THD	○	—	—	—	○
Current THD	○	—	○	—	○

Legend ○ : measured data available — : measured data not available

*1: Numerical data of any of the 1st to 50th.

*2: All orders means numerical data of all objective waveforms including the fundamental wave and all harmonics.

Voltage quality measurement data
(Voltage Fluctuation)

Items under Test	Each Phase
Voltage dip	○
Voltage swell	○
Instantaneous voltage interruption	○

Legend ○ : measured data available — : measured data not available

TIP

- Each phase/CH: indicates that measured data is available for each phase or each channel.
- Inter-phase average: represents the average of each phase of voltage, current, power factor, and phase angle.
- : represents the total of each phase of active power , reactive power, and apparent power.
- f (frequency): shows the measured frequency of a signal selected for the frequency source.

Chapter 8 Saving Measured Data

8.1	Data Save	8-2
8.2	Saving Measured Data	8-6
8.3	Memory (Reference)	8-11
8.4	Backup Memory	8-13
8.5	Copying Screen Data (Hard copy)	8-15

8.1 Data Save

8.1.1 Data Save Destination

The CW240 can save data (measured data and set values) in a PC card or internal memory. Selection of the data save destination (PC card or internal memory) is made on the Save 1/2 screen.

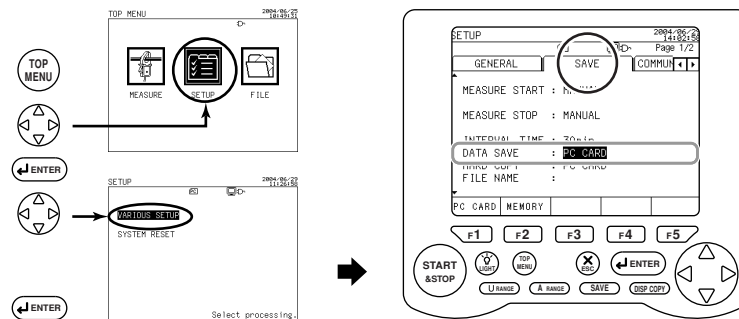

1 Displaying the Save 1/2 screen



Using the right and left direction cursor key, select the Save tab (highlighted).

2 Selecting the data save destination



Using the up and down direction cursor key, select DATA SAVE (highlighted).

SEE ALSO

For the data save destination-setting procedure, see 6.4.5, Setting Up the Data Saving Destination.

TIP

- The setting conditions (set values on the Setup screen) can be saved.
- For more information on setting files, see Section 9.6, Setting Files (Load/Save/Delete/Name Change).

8.1.2 File Names

File names (numbers) should be up to 8 alphanumeric characters.

Example: 240AMXXX.CSV

↑
8 characters or less

To specify a file name: Enter a file name on the Save 1/2 screen.

If no file name is specified: The CW240 automatically assigns a file name.

● Not Specifying a File Name

If no file name is specified, the CW240 automatically assigns a file number as shown below.

Measured Data:

File Type		File Name	File Format
Measured data file	Automatic save	Short-time interval	240AMXXX.BIN
		Standard interval	240AMXXX.CSV
	Manual save	240MMXXX.CSV	Text
Voltage quality data file	Automatic save	240ARXXX.ARM	Text
	Manual save		
Waveform data file	Automatic save	240AWXXX.WFM	Binary
	Manual save	240MWXXX.WFM	
Screen data file	Screen copy (Hard copy)	240MDXXX.BMP	Bitmap
	Manual save		

Set Values:

File Type		File Name	File Format
Setting file	Manual save	240MCXXX.SET	Text

NOTE

For the file number (XXX) part, any unassigned number from 000 to 029 is assigned in increasing numerical order. (If a number exceeds 029, an error message is displayed.)

For automatic save, a file number changes each time integral measurement is made.

For manual save (measured data or waveform data), data is added (in the same file number) each time the SAVE key is pressed.

If the number of data lines exceeds 100, if integration measured data is cleared, or if the setting conditions have been changed, the file number is changed.

8.1 Data Save

● Specifying a File Name

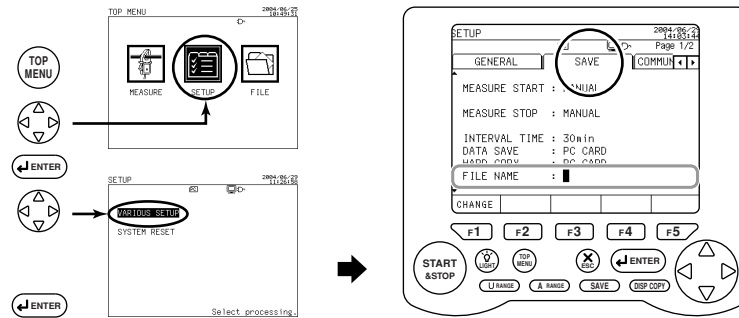

1 Displaying the Save 1/2 screen



Using the right and left direction cursor key, select the Save tab (highlighted).

2 Entering a file name



Using the up and down direction cursor key, select FILE NAME (highlighted).

3 Displaying the window



Press the F1 key (CHANGE).

The screen changes to an entry screen.

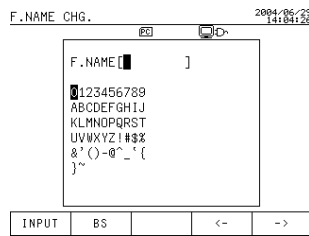

SEE ALSO

For the file name entry procedure, see 6.4.7, Setting Up a File Name.

● **File Processing**

A saved file is processed on the File screen.

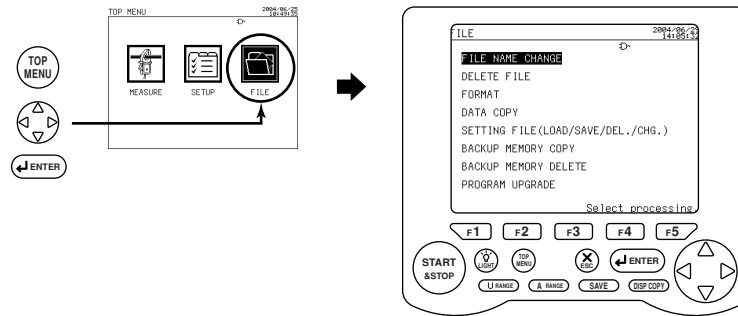

Setting Item	Description
FILE NAME CHANGE	Changes a saved file name.
DELETE FILE	Lets you select a saved file for deletion.
FORMAT	Formats a PC card or internal memory.
DATA COPY	Copies a file saved in the internal memory to a PC card.
SETTING FILE (LOAD/SAVE/DEL./CHG.)	Used to read, write, or delete a setting file or change a setting file name.
BACKUP MEMORY COPY	Copies a file in the backup memory to a PC card.
BACKUP MEMORY DELETE	Deletes a file from the backup memory.

SEE ALSO

For more information on file processing, see Chapter 9, Processing File(s).

8.2 Saving Measured Data

Manual save : A method that allows you to save measured data by pressing the **SAVE** key during measurement.

Automatic save : The instrument automatically saves data (at set time intervals) during integration measurement.

8.2.1 Setting up Items to be Saved

Measured data items to be saved need to be set up on the Save screen beforehand.

Save 1/2 screen:

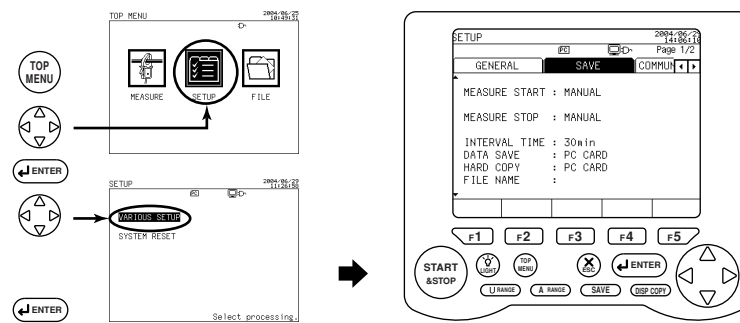

1 Displaying the Save 1/2 screen



Using the right and left direction cursor key, select the Save tab (highlighted).

2 Displaying the Save 2/2 screen



Using the up and down direction cursor key, display the Save 2/2 screen.

Save 2/2 screen

SETUP		2004/06/22 14:00:56 Page 2/2	
GENERAL	SAVE	COMMUN	
E. ENEGRY/DEM. : ON			
WAVEFORM DATA : ON			
NORMAL MEAS. : ON	INST. : ON	AVE. : ON	
HARM. MEAS. : ON	DETA. : ON	MAX. : ON	
MIN. : ON			
SAVE-TIME : 226DAYS 22:30:00			
ON	OFF		

Harm. Meas. Detail screen

SETUP		2004/06/22 14:01:57	
HARMONIC OUTPUT ITEMS			
LOAD1	ON	I1	DN
LOAD2	OFF	I2	DN
LOAD3	OFF	I3	DN
LOAD4	OFF	P	DN
		I4	OFF
		LEVEL	DN
		CONTENT	DN
		PA	DN
		TOTAL	DN
		THD	DN
OUTPUT ORDER : ALL ORD.			
* 01*	02*	03*	04*
05*	06*	07*	08*
09*	10*	11*	12*
13*	14*	15*	16*
17*	18*	19*	20*
21*	22*	23*	24*
25*	26*	27*	28*
29*	30*	31*	32*
33*	34*	35*	36*
37*	38*	39*	40*
41*	42*	43*	44*
45*	46*	47*	48*
49*	50*		
ON	OFF		

SEE ALSO

For more information on settings, see Section 6.4, Save Data Settings 1/2, and Section 6.5, Save Data Settings 2/2.

8.2 Saving Measured Data

8.2.2 Manual Save

You can press the **SAVE** key during measurement to save measured data (instantaneous values).

1 Setting up the saving conditions

Set up necessary items on the Save screen. Save 1/2, Save 2/2, and Harm. Meas. Detail screens

SEE ALSO

For more information on settings, see Section 6.4, Save Data Settings 1/2, and Section 6.5, Save Data Settings 2/2.

2 Displaying the Measure screen

The Measure screen is displayed.

This subsection describes the manual saving procedure taking the List measurement screen as an example.

(Saving of measured data does not mean the saving of data displayed on the screen, but that items set up on the Save screen will be saved.)

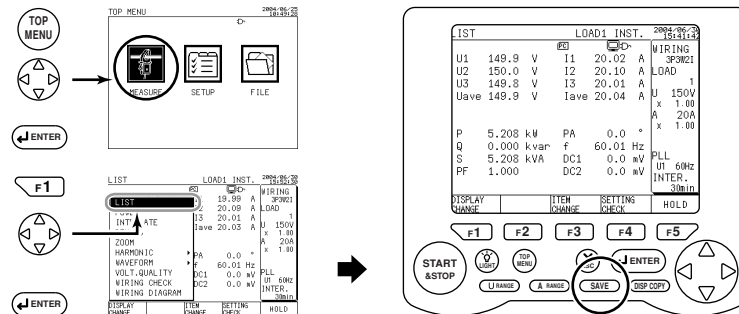

3 Saving data





SAVE Press the SAVE key.

Instantaneous values will be saved each time the SAVE key is pressed.

 **NOTE**

- Manual save is not available during integration measurement (including being on standby).
- A file name will be automatically assigned if it has not been specified:
Measured data file: 240MCXXX.CSV (XXX: 000 to 029), text data
Waveform data file: 240MWXXX.WFM (XXX: 000 to 029), binary data
- In manual save, the save settings of AVE., MAX., and MIN. items on the Save 2/2 page will be ignored (that is, the average, maximum, and minimum values are not saved).

TIP

- When DATA SAVE is set to a PC CARD, the  mark appears in the relevant area on the screen. Mark  flashes during an access to the PC card.
- If DATA SAVE is set to MEMORY, the  mark appears in the relevant area on the screen. Mark  flashes during an access to the internal memory.

8.2 Saving Measured Data

8.2.3 Automatic Save

In automatic save, the CW240 automatically saves measured data from the start to the end of integration (during integration measurement).

1 Setting up the save conditions

Setup necessary items such as setting of the start and stop times of integration, interval time for saving data, etc. on the Save screen.

Save 1/2, Save 2/2, and Harm. Meas. Detail screens

SEE ALSO

For more information on setting, see Section 6.4, Save Data Settings 1/2, and Section 6.5, Save Data Settings 2/2.

2 Displaying the Measure screen

This subsection describes the saving procedure taking the Integrate screen as an example.

(Saving of measured data does not mean the saving of data displayed on the screen, but that items set up on the Save screen will be saved.)

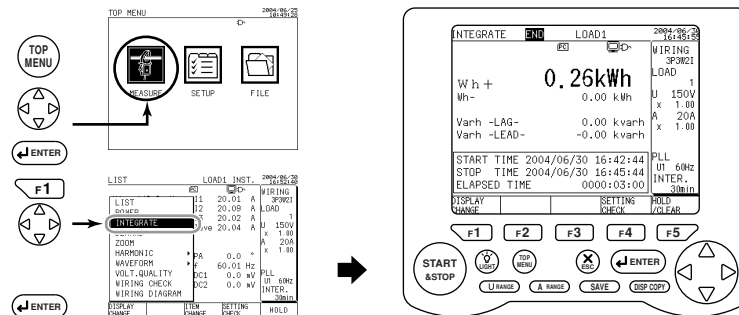

3 Saving data



Press the **START&STOP** key.

Integration starts according to the setting of the integration start method.

(There are cases where integration is on standby until integration starts.)

Measured data will be saved at every interval time (until integration ends).

8.3 Memory (Reference)

● Interval Time Setting and Data That Can be Saved

Interval Time	File Type				
	Normal Measurement	E. Energy/ Demand Measurement	Harmonic Measurement	Waveform	Voltage Quality
1 wave/100, 200, 500 ms	○ Inst. value only	×	×	×	○
1, 2, 5, 10, 15, 30 s	○	○	×	×	○
1, 2, 5, 10, 15, 30, 60 min	○	○	○	○	○

○ : Save possible × : Save not possible

● Period during Which Data Can be Saved

- For saving all items of normal measurement data, electric energy/demand measured data, or voltage quality measured data

Wiring		1P2W 4 loads	1P3W 2 loads	1P3W3I	3P3W2I 2 loads	3P3W3I, 3P4W	3P4W4I	3P3W+ 1P3W
No. of Data Items		168	196	114	208	138	142	216
Recording Media	Interval time	—	—	—	—	—	—	—
	1s	9h	8h	14h	8h	12h	12h	7h
PC card (MB)	1min	24days	21days	37days	20days	30days	30days	19days
	60min	1471days	1304days	2223days	1232days	1852days	1802days	1188days
	Internal Memory	1s	8min	7min	12min	7min	10min	10min
Internal Memory	1min	8h	7h	12h	7h	10h	10h	6h
	60min	21days	18days	32days	17days	26days	26days	17days

- For saving all items of normal measurement data, electric energy/demand measured data, all items of harmonic measured data, waveform data, and voltage quality measured data

Wiring		1P2W 4loads	1P3W 2loads	1P3W3I	3P3W2I 2loads	3P3W3I, 3P4W	3P4W4I	3P3W+ 1P3W
No. of Data Items		5624	5052	3758	6888	4390	5002	7504
Recording media	Interval time	—	—	—	—	—	—	—
	1min	17h	19h	26h	14h	22h	19h	13h
PC card (MB)	60min	44days	49days	65days	35days	56days	49days	32days
	Internal Memory	1min	12min	13min	19min	8min	16min	13min
Internal Memory	60min	12h	13h	19h	8h	16h	13h	7h

8.3 Memory (Reference)

- For saving instantaneous values of normal measurement data and voltage quality measured data



Wiring		1P2W 4 loads	1P3W 2 loads	1P3W3I	3P3W2I 2 loads	3P3W3I, 3P4W	3P4W4I	3P3W+ 1P3W
No. of Data Items		28	22	15	25	16	17	27
Recording Media	Interval time	—	—	—	—	—	—	—
	1wave	2 h	3 h	3 h	2 h	3 h	3 h	2 h
PC card (64MB)	100ms	12 h	15 h	19 h	13 h	18 h	18 h	12 h
	200ms	25 h	30 h	39 h	27 h	37 h	36 h	25 h
	500ms	62 h	75 h	98 h	68 h	94 h	90 h	64 h
	1wave	1 min	2 min	3 min	1 min	2 min	2 min	1 min
Internal Memory	100ms	10 min	12 min	16 min	11 min	16 min	15min	10 min
	200ms	21 min	25 min	34 min	23 min	32 min	31 min	22 min
	500ms	54 min	65 min	85 min	59 min	82 min	78 min	55 min
	1wave	1 min	2 min	3 min	1 min	2 min	2 min	1 min



NOTE

- Data file(s) saved at short-time interval (1 wave/100 ms/200 ms/500 ms) and waveform data file(s) are binary data. To read measured data using spreadsheet software, etc., binary data needs to be converted into text data. For software for conversion into a text file, see the CD-ROM provided for the CW240.

TIP

- When DATA SAVE is set to PC CARD, the  mark appears on the relevant area on the screen. This mark flashes during an access to the PC card.
- If DATA SAVE is set to MEMORY, the  mark appears on the screen. This mark flashes during an access to the internal memory.

8.4 Backup Memory

- When the measured data-saving destination is set to a PC card, the internal memory is used as a backup memory for the PC card. If data cannot be written into the PC card for any reason, data will be saved in the backup memory.
- If the backup memory contains data, the  mark is indicated on the screen. (Note that data in the backup memory will be retained even when power is turned OFF.)
- Data in the backup memory will be cleared each time integration measurement is started. (If the next integration measurement is made with data retained in the backup memory, such previous data will be deleted.)
- If the backup memory becomes full of data, an error message is displayed, causing a save to terminate. (Integration measurement still continues.)
- Backup time varies depending on the remaining capacity of the internal memory.
- If a PC card with free space is inserted into the CW240 during integration, successive data will be saved in the PC card under the same file name. When integration is complete, data that has been saved in the backup memory will be copied to the end of the file in the PC card. (A message is displayed, indicating that backup memory data is being copied to the PC card.)
- If no PC card with free space is inserted into the CW240 during integration, the instrument keeps on saving data in the backup memory.

8.4 Backup Memory

- If integration measurement has been completed when the PC card is full or extracted, you need to take the following steps:

If the data in the backup memory is required, copy backup data.

- Backup data can be copied on the File screen.
See Section 9.7, Backup Memory Copy.

If none of the data in the backup memory is required, delete backup data.

- Backup data can be deleted on the File screen.
See Section 9.8, Backup Memory Delete.
- You can start new integration to delete backup data.
Starting a new integration measurement causes data in the backup memory to be deleted.

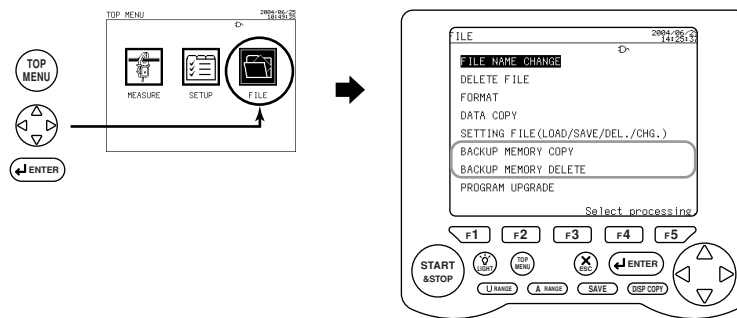

NOTE

It is recommended that even if DATA SAVE is set to PC CARD, file(s) in the internal memory be deleted before starting an integration measurement to secure the memory space for backup.

If the internal memory becomes full, data cannot be backed up in the event of a failure to save data in a PC card.

8.5 Copying Screen Data (Hard copy)

When the **DISP COPY** key is pressed during measurement, display screen data is copied (saved). For this, set up HARD COPY (PC CARD, MEMORY, or PRINTER).

When saved in a PC card or the internal memory, display screen data is saved as a bitmap file.

File name: 240MD001.bmp

1 Setting the conditions

Set up necessary items such as HARD COPY on the Save 1/2 screen.

SEE ALSO

For more information on setting, see Section 6.4, Save Data Settings 1/2.

2 Displaying the Measure screen

This section describes the screen data-copying procedure taking the Power measurement screen as an example.

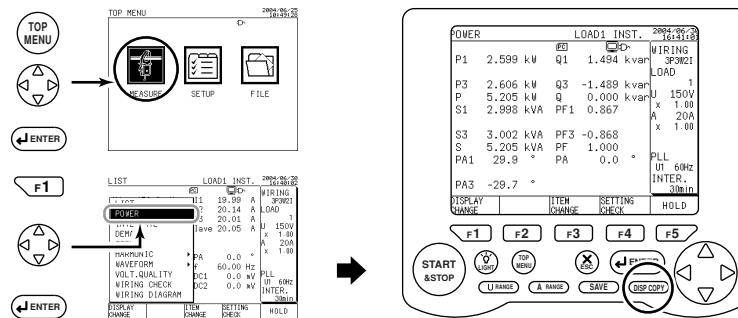

3 Copying screen data

DISP COPY

Press the **DISP COPY** key.

This causes the screen currently displayed to be saved (printed).

8.5 Copying Screen Data (Hard copy)



NOTE

- Please set up copying destination (**HARD COPY**) on Save 1/2 screen.
 - When using printer (optional), RS-232 connection destination (**CONNECT**) need to be set to Printer on Communication screen beforehand.
 - The F3 key (**PRINTER**) function indication is not shown if the setting of the RS-232 connection destination is not set to **PRINTER**.
 - When **HARD COPY** is set to **PC CARD** or **MEMORY**, the CW240 automatically assigns a file name.
Screen data file: 240MDXXX.BMP (XXX: 000 to 029), bitmap data
 - Screen data cannot be copied during integration measurement (including being on standby). The **DISP COPY** key is disabled during this period.
-
-

Chapter 9 Processing File(s)

9.1	File Processing	9-2
9.2	Changing a File Name	9-4
9.3	Deleting a File	9-6
9.4	Formatting	9-9
9.5	Data Copy	9-10
9.6	Setting Files (Load/Save/Delete/Name Change)	9-14
9.7	Backup Memory Copy	9-24
9.8	Backup Memory Delete	9-25

9.1 File Processing

A saved file can be processed as described in the table below:

File Processing Item	Description
FILE NAME CHANGE	Changes a saved file name.
DELETE FILE	Lets you select and delete a saved file.
FORMAT	Formats the internal memory or a PC card.
DATA COPY	Copies a file saved in the internal memory to a PC card.
SETTING FILE (LOAD/SAVE/DEL./CHG.)	Lets you read, write, or delete a setting file or change its file name.
BACKUP MEMORY COPY	Copies a file in the backup memory to a PC card.
BACKUP MEMORY DELETE	Deletes a file from the backup memory.
Note: PROGRAM UPGRADE	This is a feature dedicated to maintenance, which the customer must not use.

● Displaying the File Screen

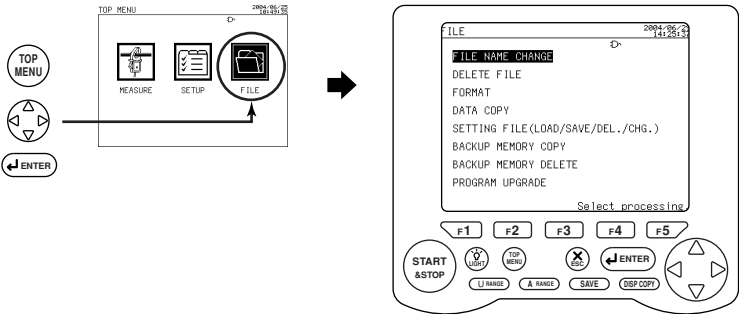

 NOTE

- PROGRAM UPGRADE is a feature dedicated to maintenance, which the customer must not operate.
- During integration measurement (including being on standby), the TOP MENU key is invalid, (disabling the Top Menu screen from being displayed). That is, file processing cannot be done.

SEE ALSO

For more information on saving data, see Chapter 8, Saving Measured Data.

9 Processing File(s)

9.2 Changing a File Name

In this section, change the name of a saved file.

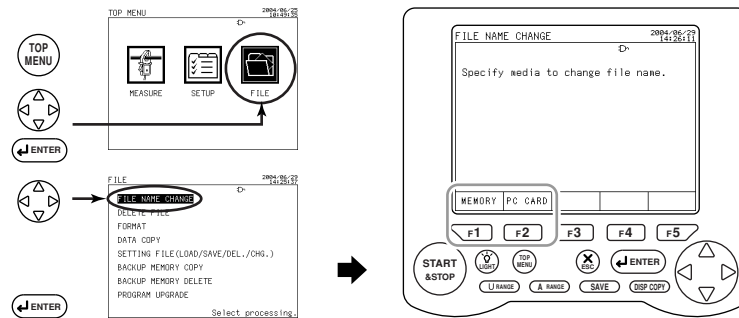

1 Selecting the save destination

Using the relevant function key, select the media to which a file is saved.

- F1: Changes a file name in the internal memory.
- F2: Changes a file name in a PC card.



2 Selecting a file

A list of files that have been saved appears. Using the cursor key, select the file whose name is changed (highlighted).

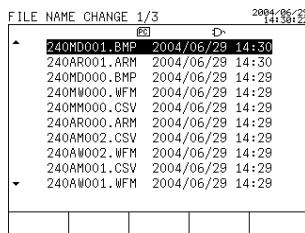

3 Confirmation

Press the ENTER key. The screen switches to the file name entry screen.



9.2 Changing a File Name

● Entering a File Name

Enter a file name with a maximum of 8 characters (alphanumeric characters).

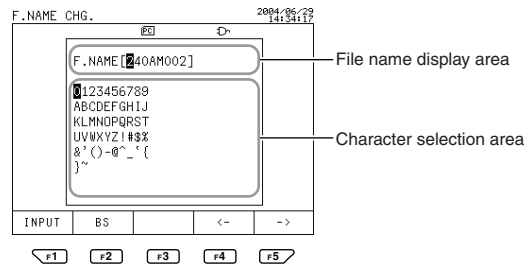

4 Entering a file name

Enter a new file name.

If you do not change a file name, press the ESC key. The screen returns to the top File screen.

SEE ALSO

For the file name entry procedure, see 6.4.7, Setting Up a File Name.

5 Confirmation



Press the ENTER key.

The screen returns to the top File screen.

9.3 Deleting a File

In this section, select and delete a saved file.

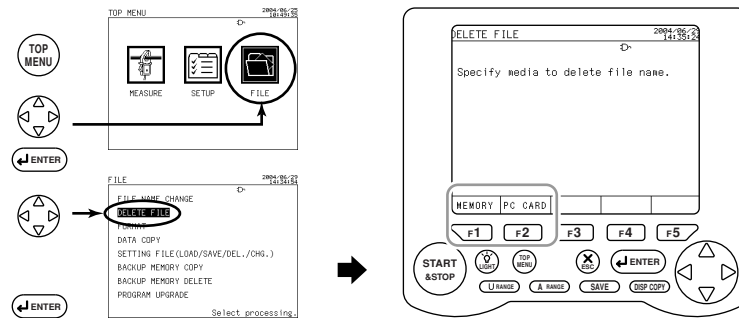

1 Selecting the media from which a file is deleted

Using the relevant function key, select the media from which a file is deleted.

F1: Deletes a file from the internal memory.

F2: Deletes a file from the PC card.



2 Selecting a file

A list of files that have been saved appears.

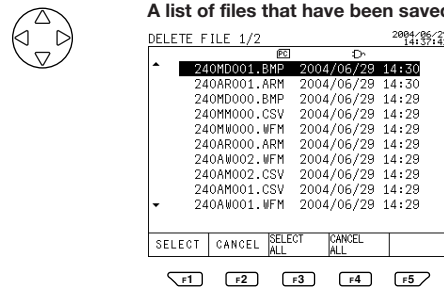

Description of the Function Keys:

F1: Selects a file to be deleted individually (symbol * appears).

F2: Cancels a file selected individually (symbol * disappears).

F3: Selects all saved files (symbol * appears on all files).

F4: Cancels all files that have been selected (all * symbols disappear).

● **Selecting/Canceling Procedure**

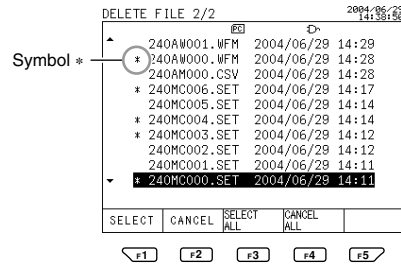

To select a file individually:

1

Selecting a file



Using the cursor key, select the file to be deleted (highlighted).

2

Selection



Press the F1 key. (Symbol * appears.)

Multiple files can be deleted. Follow the same procedure for all of them.

3

Confirmation



Press the ENTER key.

A message asking if you want to delete a file appears.

End:

To delete a file	To cancel deletion
Press the ENTER key. This deletes the selected file, causing the screen to return to the top File screen.	Press the ESC key. The screen returns to the top File screen without deleting a file.

To cancel deletion:

- Individual cancellation – CANCEL



Using the cursor key, select the file for which you want to cancel deletion (highlighted).



Press the F2 key. (Symbol * disappears.)

- Canceling all – CANCEL ALL



Press the F4 key. (All * symbols disappear.)

9.3 Deleting a File

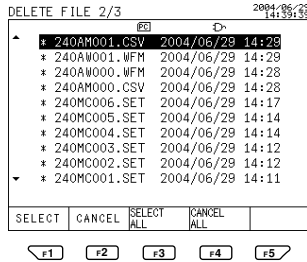

To select all files:

1

Selecting all



Press the F3 key. (symbol * is indicated on all files.)

2

Confirmation



Press the ENTER key.

A message asking if you want to delete all files appears.

End:

To delete files	To cancel deletion
Press the ENTER key. This deletes all the files, causing the screen to return to the top File screen.	Press the ESC key. The screen returns to the top File screen without deleting any files.

To cancel deletion:

- Individual cancellation – CANCEL



Using the cursor key, select the file for which you want to cancel deletion (highlighted).



Press the F2 key. (Symbol * disappears.)

- Canceling all – CANCEL ALL



Press the F4 key. (All * symbols disappear.)

9.4 Formatting

In this section, format the internal memory or PC card.

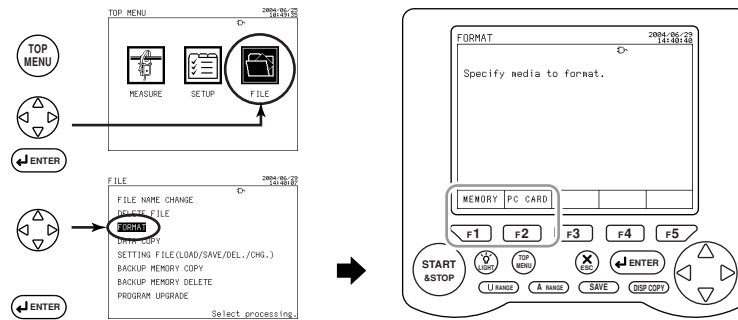

1 Selecting the media to be formatted

- Press the relevant function key to select the media to be formatted.
- F1: Formats the internal memory.
 - F2: Formats the PC card.



2 Displaying a message

Confirmation message for format appears.

End:

To perform formatting	To cancel formatting
Press the ENTER key. Formatting starts. When it is complete, the screen returns to the top File screen.	Press the ESC key. The screen returns to the top File screen without formatting.

NOTE

- To use a new PC card, you need to format it.
- When a media is formatted, all files contained in it will be deleted.
Note that a deleted file cannot be recovered.

9.5 Data Copy

In this section, copy a file saved in the internal memory to a PC card.

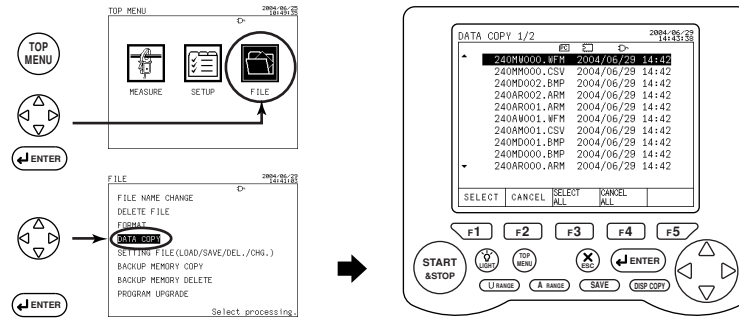

1

Selecting a file

A list of files that have been saved in the internal memory appears.

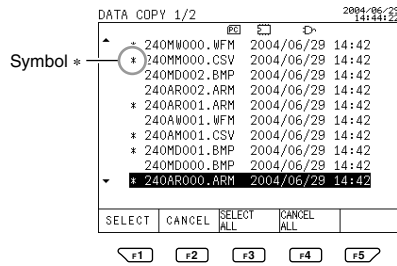

Description of the Function Keys:

- F1** : Selects a file to be copied individually (symbol * appears).
- F2** : Cancels a file selected individually (symbol * disappears).
- F3** : Selects all files together (symbol * appears).
- F4** : Cancels all files that have been selected (symbol * disappears).

● **Selecting/Canceling Procedure**

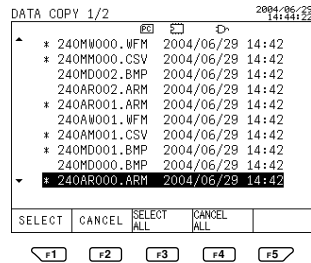

To select a file individually:

1 **Selecting a file**



Using the cursor key, select the file to be copied (highlighted).

2 **Selection**



Press the F1 key. (Symbol * appears.)

Multiple files can be copied. Follow the same procedure for all of them.

3 **Confirmation**



Press the ENTER key.

Confirmation message for copy appears.

End:

To copy a file	To cancel a copy
Press the ENTER key. This starts a copy. When it is complete, the screen returns to the top File screen.	Press the ESC key. The screen returns to the top File screen without making a copy.

Processing File(s)

9.5 Data Copy

To cancel a copy:

- Individual cancellation – CANCEL



Using the cursor key, select the file for which you want to cancel a copy (highlighted).



Press the F2 key. (Symbol * disappears.)

- Canceling all – CANCEL ALL



Press the F4 key. (All * symbols disappear.)

DATA COPY 1/2		2004/06/29 14:42:00	
	FILE	DATE	TIME
▲	* 240M000.WFM	2004/06/29	14:42
	* 240M000.CSV	2004/06/29	14:42
	* 240M002.BMP	2004/06/29	14:42
	* 240AR002.ARM	2004/06/29	14:42
	* 240AR001.ARM	2004/06/29	14:42
	* 240AM001.WFM	2004/06/29	14:42
	* 240AM001.CSV	2004/06/29	14:42
	* 240M001.BMP	2004/06/29	14:42
	* 240M000.BMP	2004/06/29	14:42
▼	* 240AR000.ARM	2004/06/29	14:42

To select all files:

1

Selecting all



Press the F3 key. (Symbol * is indicated on all files.)

2

Confirmation



Press the ENTER key.

Confirmation message for copy appears.

End:

To copy files	To cancel a copy
Press the ENTER key. This starts a copy. When it is complete, the screen returns to the top File screen.	Press the ESC key. The screen returns to the top File screen without making a copy.

To cancel a copy:

- Individual cancellation – CANCEL



Using the cursor key, select the files for which you want to cancel a copy (highlighted).



Press the F2 key. (Symbol * disappears.)

- Canceling all – CANCEL ALL







Press the F4 key. (All * symbols disappear.)

9.6 Setting Files (Load/Save/Delete/Name Change)

9.6.1 Processing of Setting File(s)

A setting file can be processed as follows:

Function Keys	Processing Item	Description
	LOAD	Reads a setting file in the setting file-dedicated memory* or PC card. (Setting is made using pre-saved set values.)
	SAVE	Writes set values to the setting file-dedicated memory* or PC card. (Save of a setting file)
	DELETE	Deletes a setting file saved in the setting file-dedicated memory* or PC card.
	NAME CHANGE	Changes the file name of a setting file saved in the setting file-dedicated memory* or PC card.

File name:

If you save a setting file, a file name is automatically assigned.
(File type: text)

Example: 240MC001.SET

↑ Extension of a setting file

To change a file name, use the F4 key (NAME CHANGE).

Setting file-dedicated memory*:

The CW240 has a memory that only saves setting files.
To distinguish this memory from the "internal memory" [Indication: MEMORY] that saves measured data, it is called a "setting file-dedicated memory [Indication: INTERNAL MEMORY]."
(It can contain up to five setting files.)

9.6 Setting Files (Load/Save/Delete/Name Change)

● Displaying the Setting File screen

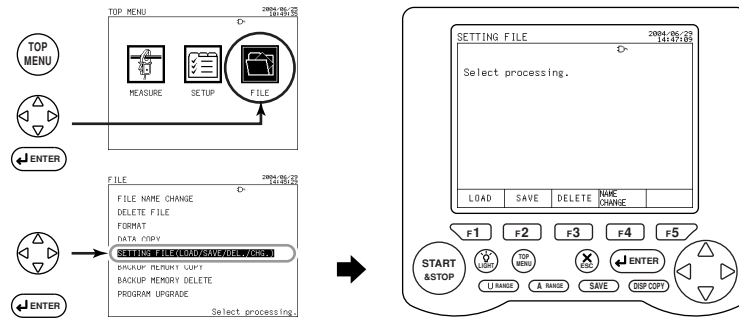

9 Processing File(s)

9.6 Setting Files (Load/Save/Delete/Name Change)

9.6.2 Load

Load a setting file saved in the setting file-dedicated memory or PC card.
Data is set to pre-saved set values (setting conditions).

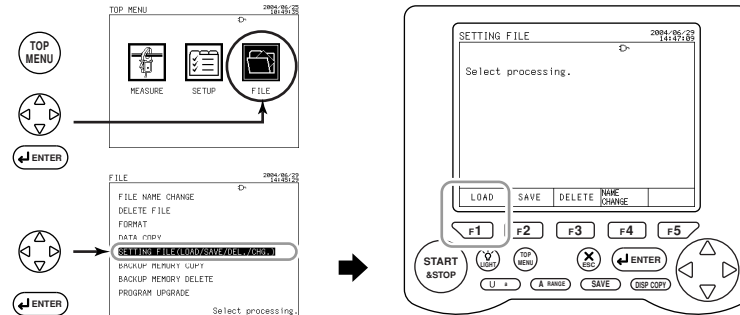

1

Load

F1

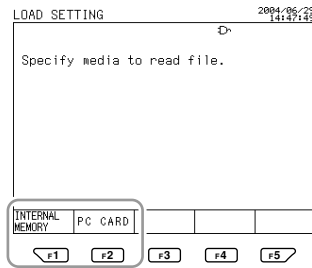

Press the F1 key.

The Load screen appears.



9.6 Setting Files (Load/Save/Delete/Name Change)

2 Selecting the loading source

  Press the relevant function key to select the media from which a setting file is loaded.

F1: loads a setting file from the setting file-dedicated memory.

F2: loads a setting file from the PC card.



A list of setting files that have been saved appears.

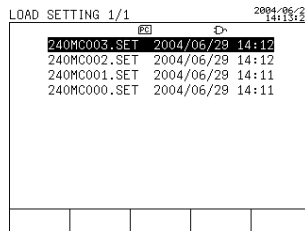

3 Selecting a file



Using the cursor key, select a setting file to be loaded (highlighted)

End:

To load a setting file	To cancel load
Press the ENTER key. This loads a setting file (settings are changed). When a load is complete, the screen returns to the top File screen.	Press the ESC key. The screen returns to the top File screen without making a load.

9.6 Setting Files (Load/Save/Delete/Name Change)

9.6.3 Save

Write the currently set conditions (set values) into the setting file-dedicated memory or PC card.
(Save of a setting file)

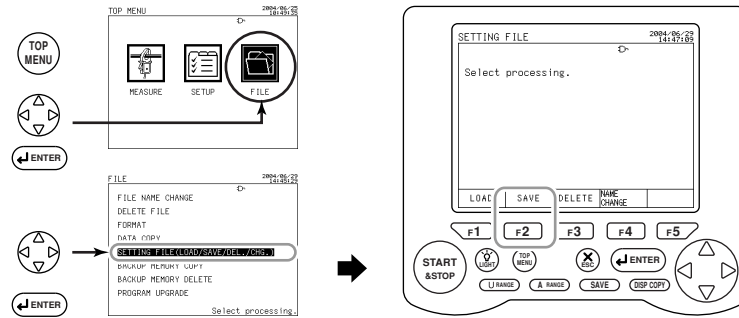

1 Save

F2

Press the F2 key.

The Save screen appears.

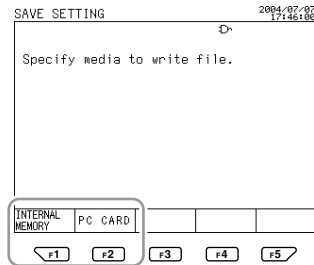

2 Selecting the save destination

F1, **F2**

Press the relevant function key to select the media to which a setting file is written. (Media in which a setting file is saved)

F1: saves a setting file to the setting file-dedicated memory.

F2: saves a setting file to the PC card.

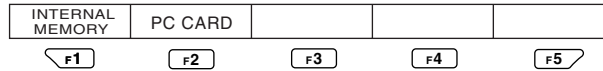

End:

When a write is complete (a setting file has been saved), the screen returns to the top File screen.

9.6 Setting Files (Load/Save/Delete/Name Change)

9.6.4 Delete

Select a setting file saved in the setting file-dedicated memory or PC card for deletion.

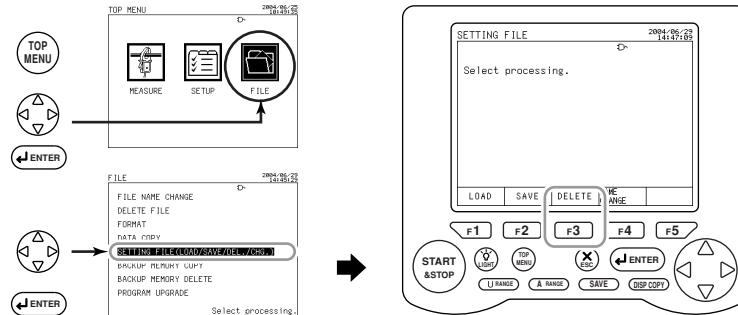

1 Deletion

F3

Press the F3 key.

The Delete screen appears.

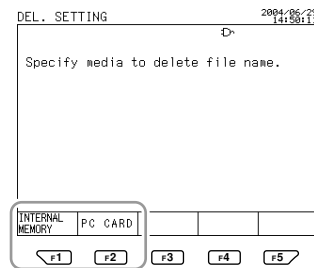

2 Selecting the media from which a file is deleted

F1, **F2**

Press the relevant function key to select the media from which a setting file is deleted.

F1: Deletes a setting file from the setting file-dedicated memory.

F2: Deletes a setting file from the PC card.



A list of setting files that have been saved appears.

9 Processing File(s)

9.6 Setting Files (Load/Save/Delete/Name Change)

● Selecting/Canceling Procedure

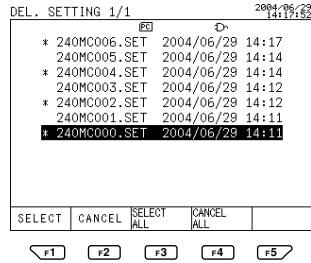

To select a file individually:

1

Selecting a file



Using the cursor key, select a setting file that is deleted (highlighted).

2

Selection



Press the F1 key. (Symbol * appears.)

Multiple setting files can be deleted. Take the same procedure for each file.

3

Confirmation



Press the ENTER key.

Confirmation message for delete appears.

End:

To delete a file	To cancel deletion
Press the ENTER key. This deletes the selected file, causing the screen to return to the top File screen.	Press the ESC key. The screen returns to the top File screen without deleting a file.

To cancel deletion:

- Individual cancellation – CANCEL



Using the cursor key, select the file for which you want to cancel deletion (highlighted).



Press the F2 key. (Symbol * disappears.)

- Canceling all – CANCEL ALL



Press the F4 key. (All * symbols disappear.)

9.6 Setting Files (Load/Save/Delete/Name Change)

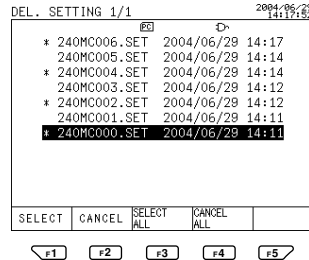

To select all files:

1 Selecting all



Press the F3 key. (symbol * is indicated on all files.)

2 Confirmation



Press the ENTER key.

Confirmation message for delete appears.

End:

To delete files	To cancel deletion
Press the ENTER key. This deletes all selected files, causing the screen to return to the top File screen.	Press the ESC key. The screen returns to the top File screen without deleting a file.

To cancel deletion:

- Individual cancellation – CANCEL



Using the cursor key, select the file for which you want to cancel deletion (highlighted).



Press the F2 key. (Symbol * disappears.)

- Canceling all – CANCEL ALL



Press the F4 key. (All * symbols disappear.)

9.6 Setting Files (Load/Save/Delete/Name Change)

9.6.5 File Name Change

In this subsection, change the file name of a setting file saved in the setting file-dedicated memory or PC card.

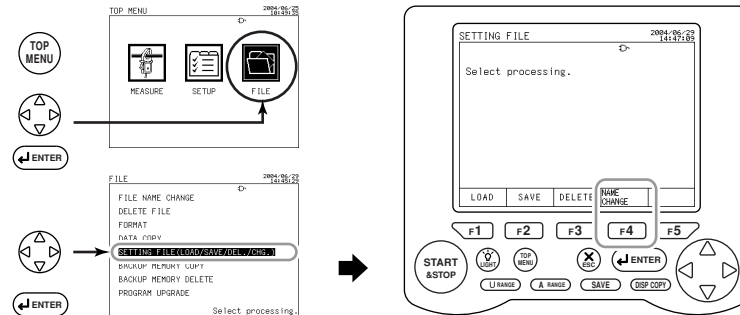

1 Changing a file name

F4

Press the F4 key.

The Name Change screen appears.

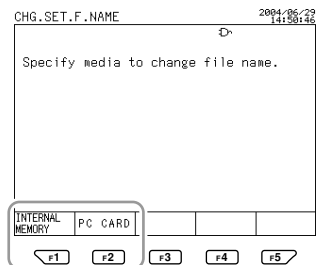

2 Selecting the media in which a file name is changed

F1, **F2**

Press the relevant function key to select the media in which the file name of a setting file is changed.

F1: changes the file name in the setting file-dedicated memory.

F2: changes the file name in the PC card

A list of setting files that have been saved appears.

9.6 Setting Files (Load/Save/Delete/Name Change)

3 Selecting a setting file



Using the cursor key, select the file whose name is changed (highlighted).

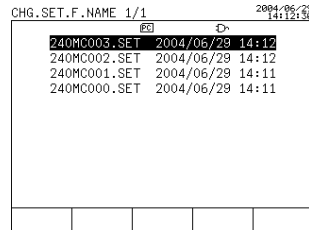

● Entering a File Name

Enter a file name with a maximum of 8 characters (alphanumeric characters).

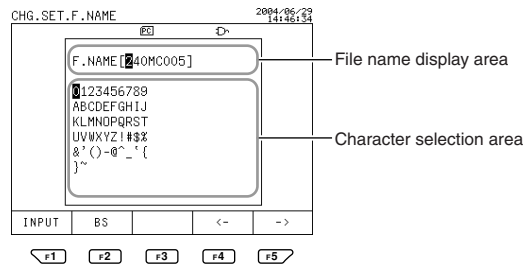

4 Entering a file name

Enter a new file name.

If you do not change the setting, press the ESC key. The screen returns to the top File screen.

SEE ALSO

For the file name entry procedure, see 6.4.7, Setting Up a File Name.

5 Confirmation



Press the ENTER key.

The screen returns to the top File screen.

9.7 Backup Memory Copy

If data cannot be written to the PC card for any reason, it will be saved in the backup memory.

When the backup memory contains data, the relevant  mark is displayed on the screen.

A file in the backup memory can be copied to the PC card.

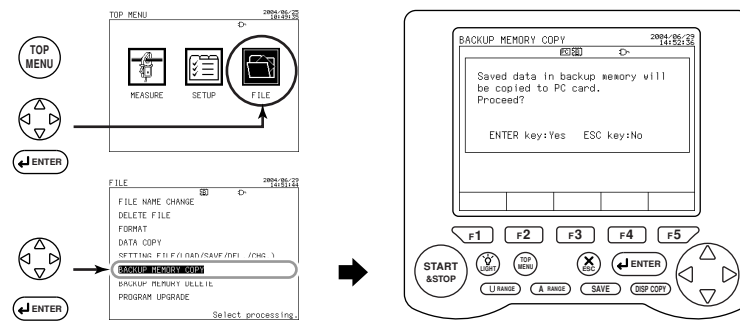

1 Copy

Confirmation message for copy appears.

End:

To copy a file	To cancel a copy
Press the ENTER key. A file is copied to the PC card, letting the screen return to the top File screen.	Press the ESC key. The screen returns to the top File screen without making copy.

SEE ALSO

For more information on the backup memory, see Section 8.4, Backup Memory.

9.8 Backup Memory Delete

In this section, a file is deleted from the backup memory.

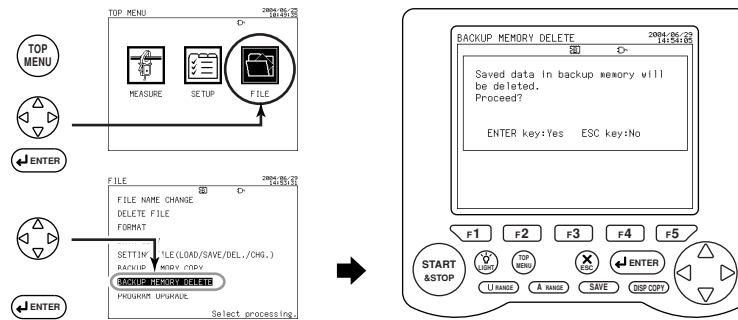

1 Deletion

Confirmation message for delete appears.

End:

To delete a file	To cancel deletion
Press the ENTER key. A file is deleted from the backup memory, letting the screen return to the top File screen.	Press the ESC key. The screen returns to the top File screen without making a deletion.

NOTE

Be aware that a deleted file cannot be recovered.

TIP

Note that starting a new integration measurement causes data in the backup memory to be deleted.

SEE ALSO

For more information on the backup memory, see Section 8.4, Backup Memory.

Chapter 10 Using the Communication Function (RS-232)

10.1 Description of the Communication Function	10-2
10.2 Using a Personal Computer	10-4
10.3 Using a Printer	10-6

10.1 Description of the Communication Function

The CW240 allows you to connect a personal computer (PC) or printer (optional) using the RS-232 interface.

Personal computer:

Connecting a PC to the CW240 allows measured data to be transferred to the PC. CW240 setup can also be made from the PC.

Printer:

Connecting the printer to the instrument allows measured data or settings in the CW240 main unit to be printed out.

● **Communication Function Manual**

The details of the communication function are described in the Communication Function Manual (IM CW240C-E) contained in the supplied CD-ROM.

Contents of the Communication Function Manual

- RS-232 interface functions and specifications
- Connection using the RS-232 interface
- Combination of handshaking methods
- Combination of data formats
- Commands

10.1 Description of the Communication Function

● CW240 Setup

To use the RS-232 function, you need to set up the CW240. Setting is made in the Communication panel in the Setup screen.

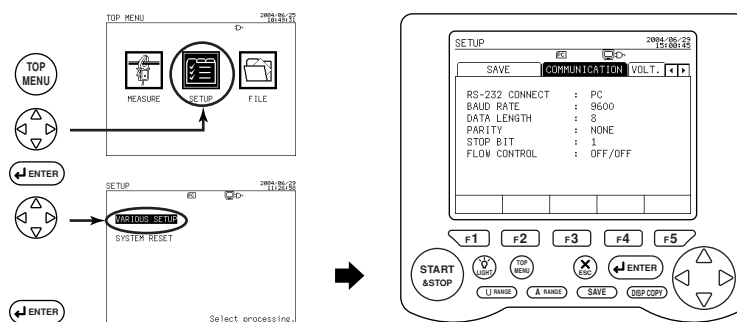

1 Displaying the Communication screen



Using the right and left direction cursor key, select the Communication tab (highlighted).

Item	Setting		Default	
RS-232 CONNECT	<1> PRINTER	<2> PC	PC	
BAUD RATE	38400 bps	4800 bps	9600 bps	
	19200	2400		
	9600	1200		
DATA LENGTH	<1> 7	<2> 8	8	
PARITY	<1> EVEN	<2> ODD	<3> NONE NONE	NONE
STOP BIT	<1> 1	<2> 2	1	
FLOW CONTROL	<1> OFF/OFF	<2> XON/XON	OFF/OFF	
	<3> XON/RS	<4> CS/RS OFF/OFF		

SEE ALSO

For more information on the setting procedure, see the following:

Chapter 6, Configuring Settings

Section 6.6, Communication Settings

10.2 Using a Personal Computer

10.2.1 Connecting a PC

Connecting a PC to the CW240 allows measured data to be output to the PC. CW240 setup can also be achieved from the PC.

● Connecting a PC

<1> Turn OFF the Power switches of the PC and CW240.

<2> Connect the PC to the CW240.

(Make connections referring to the following figure.)

Use a cross cable for connection between the PC and CW240.

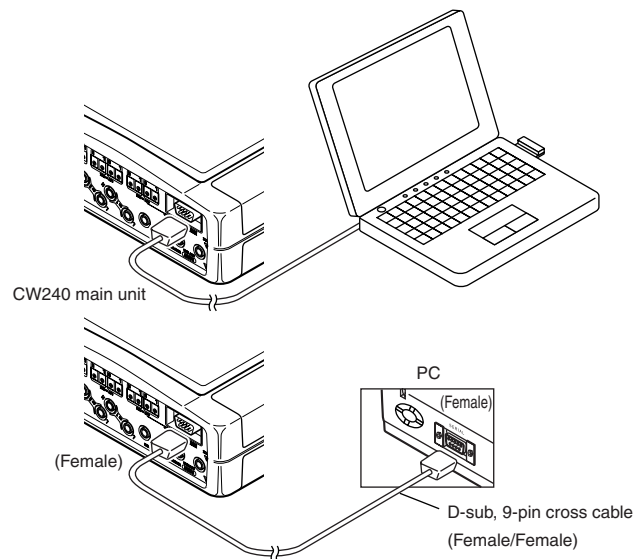

 **NOTE**

- When RS-232 CONNECT is set to PC, the  mark is indicated on the screen. This mark flashes during communication with a PC.
 - The set values of the communication conditions must match the settings of the PC connected.
For more information on setting communication conditions, see Section 6.6, Communication Settings.
-

10.3 Using a Printer

10.3.1 Connecting a Printer

Connecting the printer (optional) to the CW240 allows measured data or set values saved in the CW240 main unit to be printed out.

● **Printer Specifications**

Model: 97010

Seiko Instrument, model DPU-414 printer

Specifications:

Printing method	Thermo-sensitive serial dot type
Number of displayable digits	80
Character configuration	9 × 7 dot matrix
Printing speed	52.5 mm/sec
Paper width	112 mm

Connection:

Use the RS-232 port.

Cable D-sub 9-pin to D-sub 9-pin straight cable
(male) (female)

● **Connecting the Printer**

Use the straight cable (noted above) for connection between the printer and CW240 main unit.

- <1> Turn OFF the printer's Power switch (the Power lamp goes off).
- <2> Connect the printer and CW240 main unit (make connections referring to the figure below).

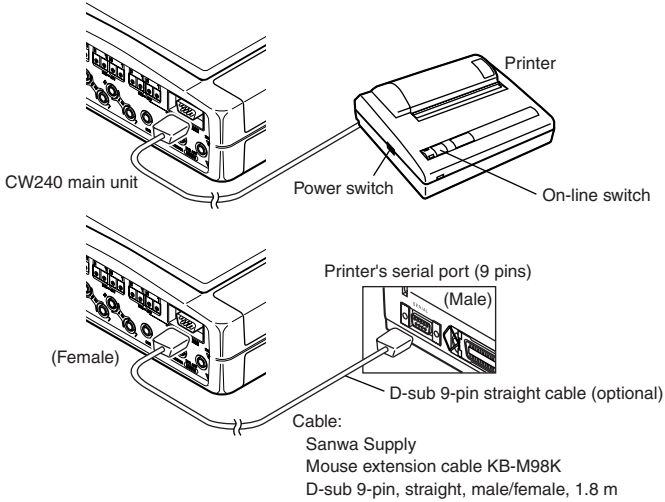

10.3 Using a Printer

10.3.2 Setting up the Printer

The printer is set up using three DIP switches (ON/OFF).
Follow the procedure below to output (print out) setting information.
<1> With the printer's On-line Switch held down, turn ON the printer's Power switch. This causes the printer settings to be output.
<2> Check that the settings are specified as shown below.

Initial Printer Settings (DIP Switch Settings)

DIP- SW setting mode:

DIP switch 1

Setting	Setting Item	ON	OFF
1 (OFF)	Input method setting	Parallel	Serial
2 (ON)	Printing speed	High speed	Low speed
3 (ON)	Auto loading	Enable	Disable
4 (OFF)	CR function	New line	Carriage return
5 (ON)	Setting command	Valid	Invalid
6 (OFF)	Printing density select: 100%		
7 (ON)			
8 (ON)			

DIP switch 2

Setting	Setting Item	ON	OFF
1 (OFF)	Printing mode	40 digits	80 digits
2 (ON)	User-defined character backup	Enable	Disable
3 (ON)	Character type	General	Special
4 (ON)	Zero font	0	∅
5 (ON)	International character select: Japanese		
6 (ON)			
7 (ON)			
8 (ON)			

DIP switch 3

Setting	Setting Item	ON	OFF
1 (ON)	Data bit length	8 bits	7 bits
2 (ON)	Provision of parity	Not provided	Provided
3 (ON)	Parity setting	Odd	Even
4 (OFF)	Control flow	H/W Busy	XON/XOFF
5 (OFF)	Baud rate select: 9600 bps		
6 (ON)			
7 (ON)			
8 (ON)			

<3> Turn OFF the printer's Power switch.

TIP

For the procedure regarding changing printer settings, see the operation manual supplied with the printer.

10.3 Using a Printer

10.3.3 Manual Printout (Instantaneous Values)

In this subsection, press the SAVE key to print measured data (instantaneous values) on the printer.

Note that for this, settings for printing on the printer (COMMUNICATION, SAVE) need to be made.

● Setting

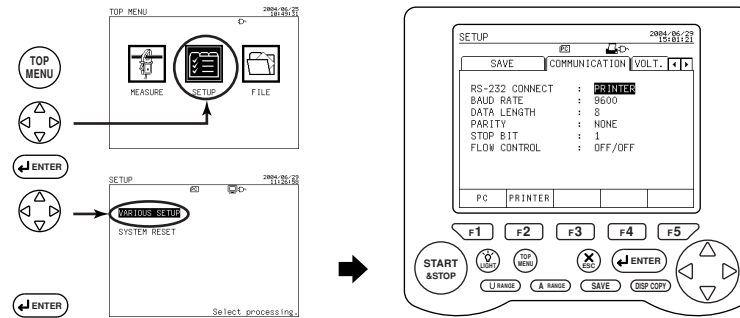

1

Setting on the Communication screen



Using the right and left direction cursor key, select the Communication tab (highlighted).

- RS-232 CONNECT is set to PRINTER.
- Configure settings required for communication with the printer.

2 Setting on the Save 1/2 screen



Using the right and left direction cursor key, select the Save tab (highlighted).

Configure settings required for data save.

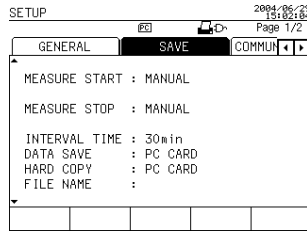

3 Setting on the Save 2/2 screen



Using the up and down direction cursor key, select the Save 2/2 (highlighted).

Set up the items to be saved.

Save 2/2 screen

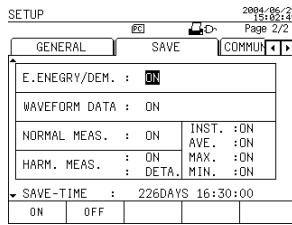

Harm. Meas. Detail screen

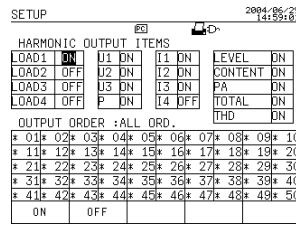

10.3 Using a Printer

● Measurement/Measured Data Printout

1 To the Measure screen

The Measure screen is displayed.

The following paragraph describes the measured data-printing procedure taking the List measurement screen as an example.

(Printout of measured data does not mean printing of the data displayed on the screen, but that items set up on the Save screen are printed out.)

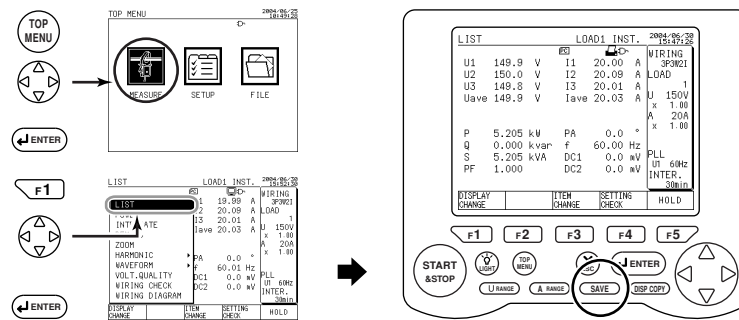

2 Printing out data

SAVE Press the SAVE key.

Instantaneous values will be printed out on the printer each time the SAVE key is pressed. Mark  flashes during printing on the printer.

(Measured data is also saved in the data save destination.)

 **NOTE**

- If RS-232 CONNECT has been set to PRINTER, the  mark is indicated on the screen.
 - During integration measurement (including being on standby), manual printing on the printer cannot be made.
-

SEE ALSO

For the setting procedure, see Chapter 6, Configuring Settings.

For more information on data save, see Chapter 8, Saving Measured Data, and 8.2.2, Manual Save.

10.3 Using a Printer

10.3.4 Automatic Printout (Integration Measurement)

Measured data obtained from the start to end of integration (during integration measurement) can be printed out automatically.

For this, settings for printout on the printer (COMMUNICATION, SAVE) need to be made.

Printing (output) is determined by interval time.

● Setting

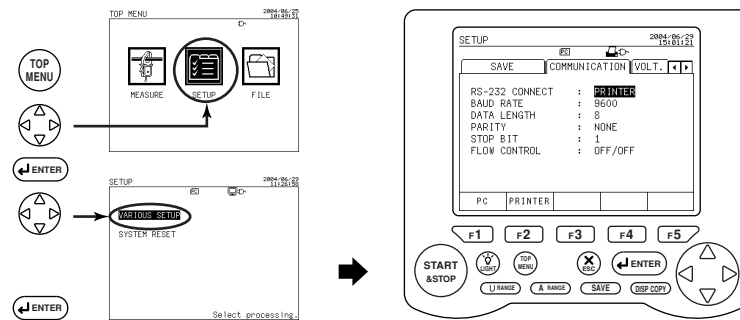

1 Setting on the Communication screen



Using the right and left direction cursor key, select the Communication tab (highlighted).

- RS-232 CONNECT is set to PRINTER.
- Configure settings required for communication with the printer.

2 Setting on the Save 1/2 screen



Using the right and left direction cursor key, select the Save tab (highlighted).

Configure settings required for integration measurement and data save.

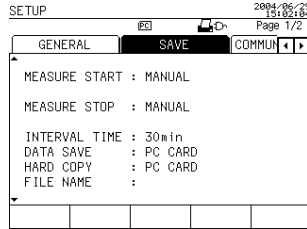

3 Setting on the Save 2/2 screen



Using the up and down direction cursor key, select the Save 2/2 (highlighted).

Set up the items to be saved.

Save 2/2 screen

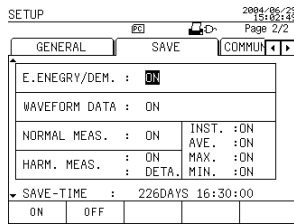

Harm. Meas. Detail screen

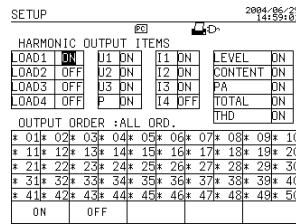

10

Using the Communication Function (RS-232)

10.3 Using a Printer

● Measurement/Measured Data Printout

1 To the Measure screen

The Measure screen is displayed.

The following paragraph describes the measured data-printing procedure taking the Integrate screen as an example.

(Printout of measured data does not mean printing of the data displayed on the screen, but that items set up on the Save screen are printed out.)

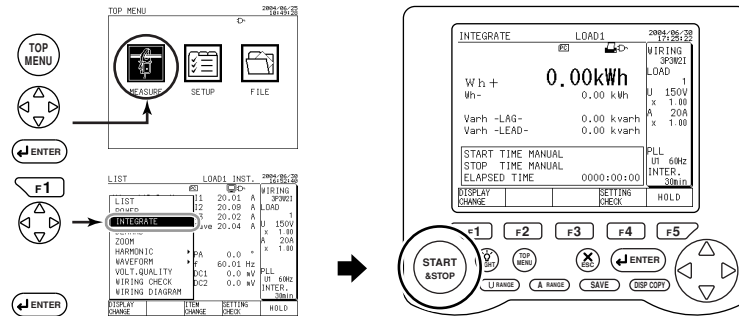

2 Printing out data

Press the START&STOP key.

This starts integration according to the setting of the integration start method.

(There are cases where integration enters a standby state until it is started.) Measured data is printed out on the printer at every interval time (until integration ends).

Symbol  flashes on the printer during printing.

(Measured data is also saved in the data save destination.)

 **NOTE**

- If RS-232 CONNECT is set to PRINTER, the  mark is indicated on the screen.
 - If the interval time is set to 30 seconds or less, measured data cannot be printed out automatically on the printer.
 - To print measured data automatically, set the interval time to more than 1 minute.
 - If several items are set for printout, printing may not end within the interval time. In that case, no printing is made in the next interval time.
-

SEE ALSO

For the setting procedure, see Chapter 6, Configuring Settings.

For more information on data save, see Chapter 8, Saving Measured Data, and 8.2.3, Automatic Save.

10.3 Using a Printer

10.3.5 Screen Data Copy

In this subsection, press the DISP COPY key to print display screen data on the printer. (Hard copy)

For this, settings for printing on the printer (COMMUNICATION, SAVE) need to be made.

● Setting

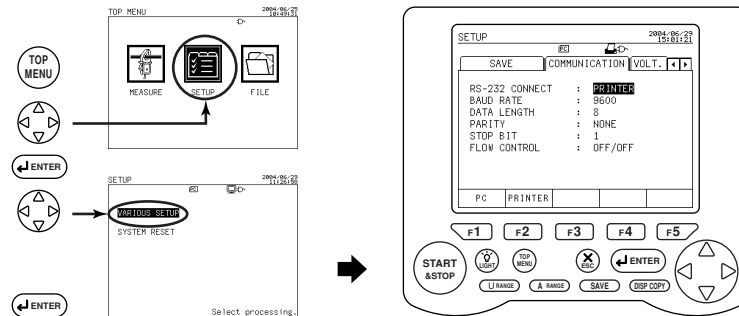

1 Setting on the Communication screen



Using the right and left direction cursor key, select the Communication tab (highlighted).

- RS-232 CONNECT is set to PRINTER.
- Configure settings required for communication with the printer.

2 Setting on the Save 1/2 screen



Using the right and left direction cursor key, select the Save tab (highlighted).

Set HARD COPY to PRINTER.

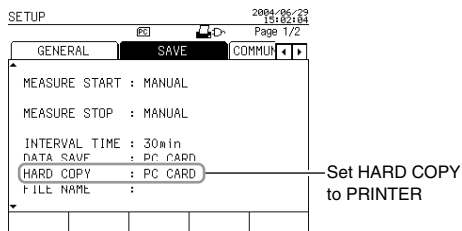

● Measurement/Display Screen Printout

1 To the Measure screen

The Measure screen is displayed.

The following paragraph describes the screen data-printing procedure taking the Power screen as an example.

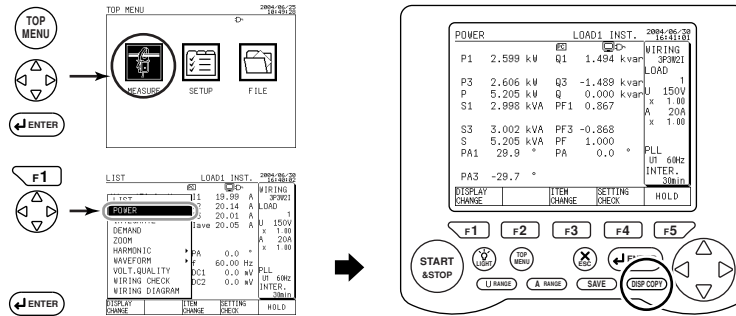

It is recommended that when printing display screen data, press the F5 key to hold the readings and then press the DISP COPY key to save them.

2 Copying screen data



Press the DISP COPY key.

This causes currently displayed screen data to be printed out on the printer.

The mark flashes on the printer during printing.

NOTE

- If RS-232 CONNECT is set to PRINTER, the mark is indicated on the screen.
- During integration measurement (including being on standby), screen data cannot be printed out on the printer.

SEE ALSO

For the setting procedure, see Chapter 6, Configuring Settings.

For more information on data save, see Chapter 8, Saving Measured Data, and Section 8.5, Copying Screen Data (Hard copy).

Chapter 11 PC Card

11.1 PC Card Specifications	11-2
11.2 Inserting and Removing the PC Card.....	11-3
11.3 Formatting the PC Card	11-4
11.4 Saving in the PC Card	11-5

11.1 PC Card Specifications

With the CW240, measurement data and setting values can be saved in a PC card. Also, stored setting values can be read out and used for settings.

The PC card interface used in this device conforms to the following PC card standards.

- PCMCIA
- Japan Electronic Industry Development Association (JEIDA)

Slot: TYPE II x 1 set
Card Type: Flash ATA
Format: MS-DOS format

● **PC cards for which operation has been confirmed**

Compact Flash (using a PC card adapter)

Company Name	Model	Capacity
Yokogawa M&C Corporation SanDisk Corporation-made	97031	32 MB
	97032	64 MB
	97033	128 MB
	97034	256 MB
	97035	512 MB



NOTE

- **Be sure to format the PC card before use. (File processing)**
- **Some types of PC card cannot be used. Use the cards for which operation has been confirmed, listed above.**
- **See the operation manual accompanying the card for details regarding its handling.**

11.2 Inserting and Removing the PC Card

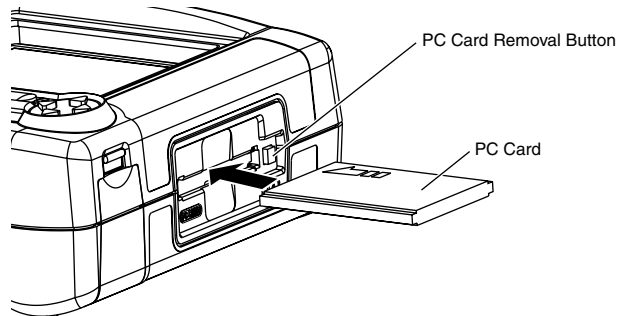

● Insertion Method

With the front surface of the card facing up (the direction the arrow is pointing), insert the PC card securely into the PC card slot on the side of the CW240.

● Removal Method

Press the removal button next to the card, and remove the card. The removal button has two states, either protruding or pressed in. (The figure above shows the button pressed in.)

When the button is protruding: The card can be removed after the button has been pressed. Pull the card out to remove it.

When the button is pressed in: If the button is pressed, it will protrude. Press the button again. The card can then be removed. Pull the card out to remove it.

NOTE

- Confirm the following before removing the card.
 - Continuous measurement is not being performed.
 - The card is not being accessed. ( will be flashes during access.) (Stored files or the main unit may be damaged if the card is removed during access.)
- Remove the PC card from the main unit when shipping this device.

11.3 Formatting the PC Card

New PC cards are formatted using file processing.

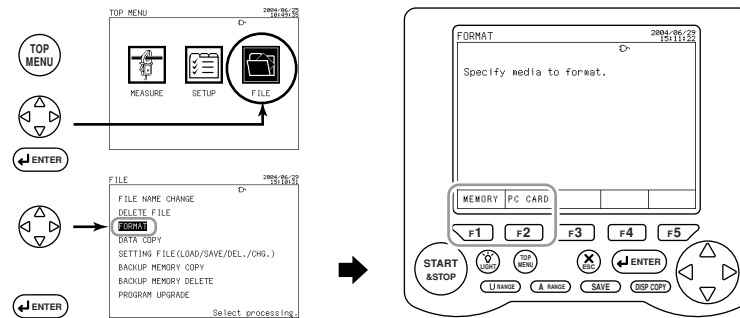

1 Selecting the object to format.

F2

Press the F2 key.

(The PC card will be formatted.)



2 Message Display

Confirmation message for format is appears.

<End>

To format	To cancel formatting
Press the ENTER key. Formatting begins. When formatting has been completed, the display returns to the top screen of file processing.	Press the ESC key. Formatting is not performed, and the display returns to the top screen of file processing.

11.4 Saving in the PC Card

● Saving measurement data

Measurement data can be stored in either the PC card or internal memory. When saving in the PC card, select the PC card as the data storage destination.

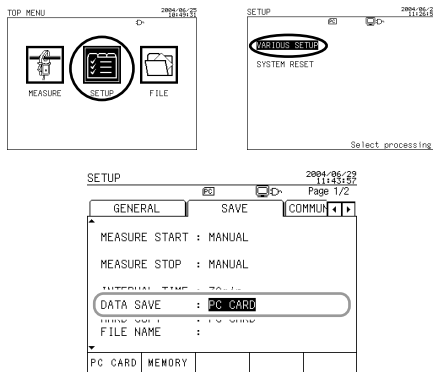

Measurement data (files) saved in the internal memory can be copied to the PC card. (FILE: DATA COPY)

SEE ALSO

For more information on saving measurement data, see Chapter 8, Saving Measurement Data.

For more information on file processing, see Chapter 9, Processing File(s).

11.4 Saving in the PC Card

● File Processing

LOAD (Reading) : Sets CW 240 with saved setting conditions.

SAVE (Writing) : Saves setting conditions (setting values). (Setting file creation) It is also possible to delete setting files and change file names.

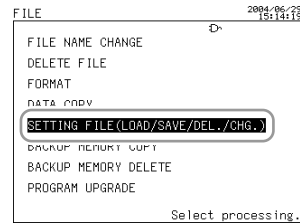
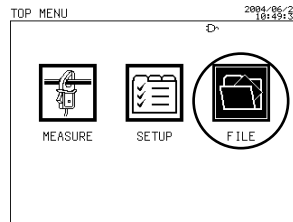

LOAD(Reading)

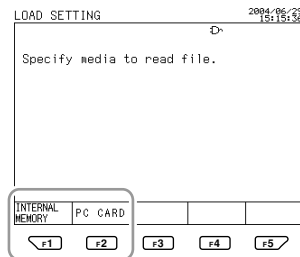
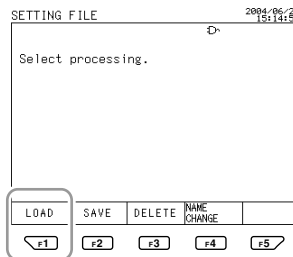

SAVE(Writing)

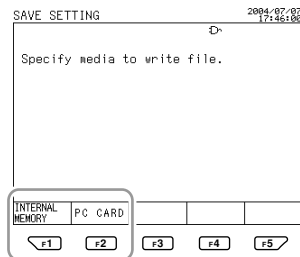
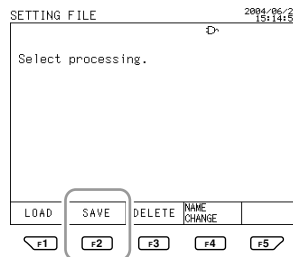

11.4 Saving in the PC Card

Select the setting file-dedicated memory (internal memory) or PC card for setting file processing.

SEE ALSO

For more information on file processing, see Section 9.6, Setting Files (Load/Save/Delete/Name Change) in Chapter 9, Processing File(s).

Chapter 12 Using External Control Input/Output

12.1 External Control Input/Output	12-2
12.2 Connecting External Control Terminals	12-3
12.3 Using Multiple CW240 Units in Synchronization	12-4

12.1 External Control Input/Output

The start and end of integration measurement can be controlled externally. Also, the start and end of integration measurement can be synchronized when using multiple units of this device.

● Input/Output Signal Example

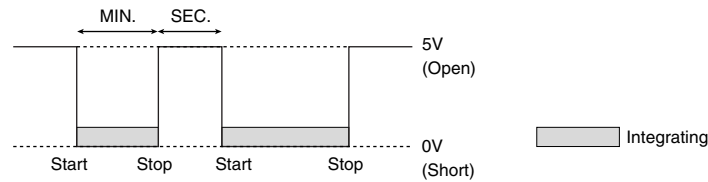

<Input>

The control input signal is 0 V/5 V (Low/High), or terminal Short/Open. Integration measurement is performed when the external control input is Low or Short, and is stopped when the input is High or Open.

Input Level	Low: 0.0 to 0.8 V High: 2.0 to 5.0 V
Allowable Voltage	-0.5 to 5.5 V
Minimum Time	Seconds

<Output>

The control output signal is 0V/5V (Low/High). It is Low when integration measurement is being performed, and High when not being performed.



NOTE

- The  mark is displayed when integration is being performed through the external control signal.
- Start/end of integration through the external control signal takes priority over manual or time-and-date settings.
- The external control signal is valid even during integration standby or when the setup screen is displayed. However, it is invalid while integration measurement is being performed.

12.2 Connecting External Control Terminals

● Terminal Diagram

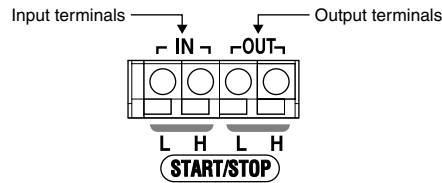

● Connection Method

<1>

Insert the signal line while pressing the rectangular portion at the bottom of the terminal with a flathead screwdriver, etc.

<2>

The signal line is secured when the screwdriver is removed.

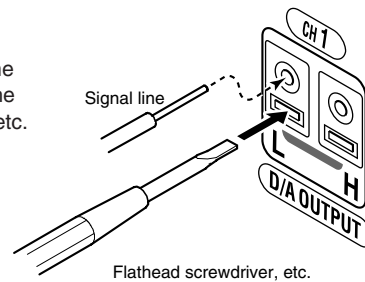

NOTE

- The input circuit may be damaged if voltage exceeding the allowable input voltage range (---S0.5 to 5.5V) of the signal input terminal is input.
- Be careful not to mistake the input terminal and the output terminal when making connections.

● Usable Signal Lines

Suitable wiring : Solid wire $\phi 1.0$ (AWG18); Stranded wire 0.75 mm^2

Usable wiring : Solid wire $\phi 0.4$ to 1.0 (AWG26 18)

Stranded wire 0.3 to 0.75 mm^2 (AWG22 20)

Strand diameter $\phi 0.18$ or higher

Standard stripped wire length 10 mm

12.3 Using Multiple CW240 Units in Synchronization

- When synchronizing through an external signal

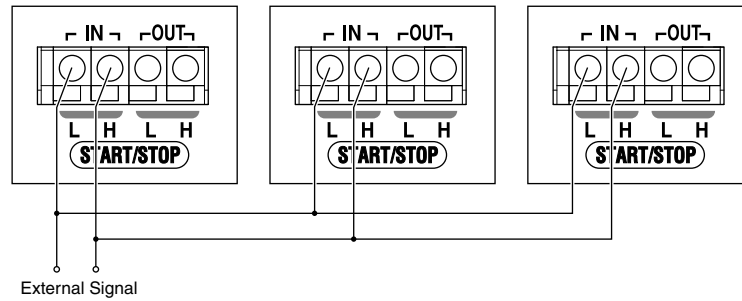

- When synchronizing device 2 and device 3 with the external control output signal of device 1

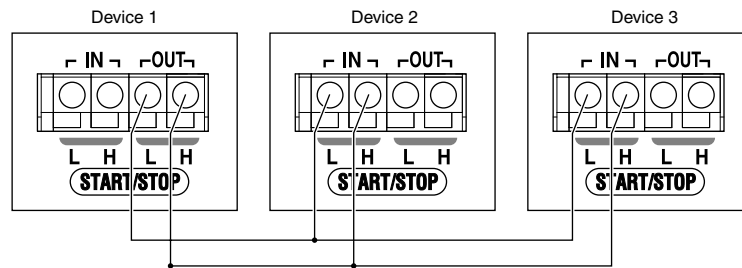

Chapter 13 Using Analog Input/Output (Optional)

13.1 Analog Output (DA Output)	13-2
13.2 Analog Input	13-6
13.3 Connecting Analog Input/Output Terminals	13-8

13.1 Analog Output (DA Output)

● Output (4CH)

The CW240 can convert measurement values to direct current voltage signals and output them.

13.1.1 Analog Output Specifications

Output Voltage : ± 1 VFS of the rated value of each range

Output Current : ± 1 mA maximum

Output Quantity: 4CH

Output Data : Selected from measurement items

Accuracy : \pm (measurement accuracy + 0.5% F.S.)

Response : 3 times or less the input signal frequency
(excluding harmonic measurement)
16 times or less the input signal frequency
(harmonic measurement)

Update Cycle : 1 cycle of the input signal frequency
(excluding harmonic measurement)
16 cycles of the input signal frequency
(harmonic measurement)

● Response

<Other than harmonic measurement>

DA output is output after the input signal waveform.

The delay (response) is 3 times or less a single cycle of the input signal frequency (3 cycles or less).

<Harmonic measurement>

DA output is output after the input signal waveform.

The delay (response) is 16 cycles or less of the input signal frequency.

13.1.2 Analog Output Setting Items

Items that can be set as output are given in the following table.

Item	Element	Order	Magnification	Output Rate				
NORMAL	Voltage (U1, U2, U3, Uave)	-	-	-				
	Current (I1, I2, I3, I4, Iave)							
	Power (P)							
	Reactive power (Q)							
	Apparent power (S)							
	Power factor (PF)							
	Phase angle (PA)							
	Frequency (F)							
E. ENERGY	E. ENERGY Active energy (Wh+)	-	-	1V/1kWh				
	Regenerative energy (Wh-)			1V/5kWh				
	Lagging reactive energy (Varh+)			1V/10kWh				
	Leading reactive energy (Varh-)			1V/50kWh				
				1V/100kWh				
Harmonics	LEVEL	1 to 50	1, 10, and 100 times	-				
					CONTENT	1 to 50	1, 10, and 100 times	-
	TOTAL VAL	-	-	-				
					THD	-	-	-

 **NOTE**

- Analog output items that can be set vary depending on the wiring.
- For measurement of multiple loads, analog output items can be selected on a load basis. A number representing load(s) is appended following each element (e.g., I1_1, I1_2, P_1, and P_2).
- For Scott connections, a symbol representing which load is applied is appended following each element (e.g., U1_3P, U1_1P, P_3P, and P_1P).

13.1 Analog Output (DA Output)

13.1.3 Measurement Values and Output Characteristics

Analog output changes according to the measurement value, as indicated below.

● Excluding integration values and frequency

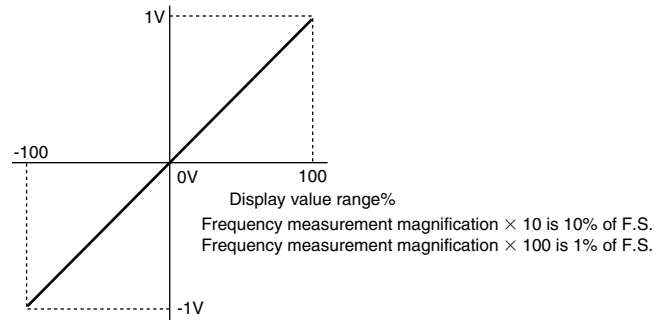

● Integration

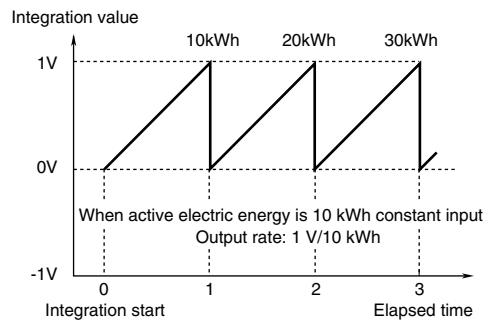

● Frequency

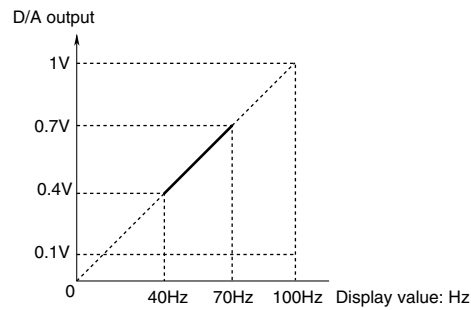

13.1.4 Setting Analog Output

Settings are made on the analog I/O screen.

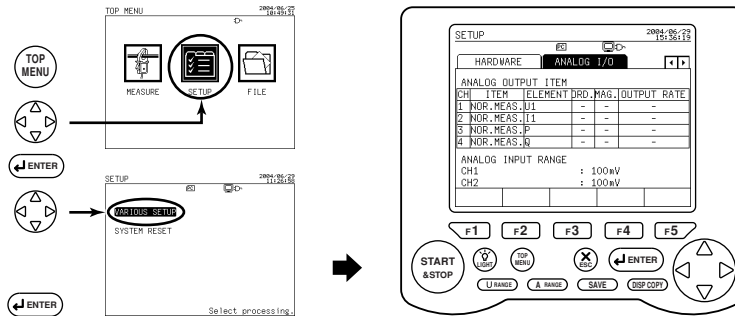

1 Display the Analog I/O Screen.



Using the right and left cursor keys, select the Analog I/O tab (highlighted).

SEE ALSO

For more information on the setting method, see Section 6.9, Analog I/O Settings.

13.2 Analog Input

13.2.1 Analog Input

- **Input (2CH)**

The CW240 can measure a direct current voltage signal.

Electric power measurement data and environmental measurement data can be managed collectively by measuring the output signals of thermometers and illuminometers.

13.2.2 Analog Input Specifications

Input Range	: 3 ranges, 100 mV/1 V/5V
Input Resistance	: Approx. 100 k Ω
Accuracy	: $\pm 0.5\%$ of F.S.
Resolution	: Polarity + 11 bits
Sample Rate	: Approx. 20 mS

13.2.3 Setting Analog Input

Settings are made on the analog I/O screen.

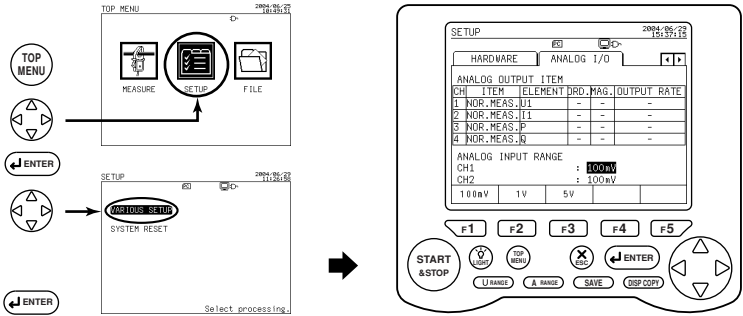

1 Displaying the Analog I/O Screen



Using the right and left cursor keys, select the Analog I/O tab (highlighted).

2 Changing the range



Using the up and down cursor keys, select CH1 (highlighted). The function key labels change.

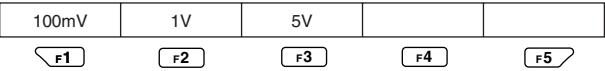

Default: 100 mV

3 Setting a range.

F1 to **F3** Press the corresponding function key to set the range. Repeat steps 2 and 3 to set CH2.

Ending setup:

To also change another setting: Select a desired setting using the cursor keys.	To return to the Top Menu: ESC key	To switch to the measurement screen: ENTER key
--	---------------------------------------	---

SEE ALSO

For more information on the setting method, see Section 6.9, Analog I/O Settings.

13.3 Connecting Analog Input/Output Terminals

● Terminal Diagram

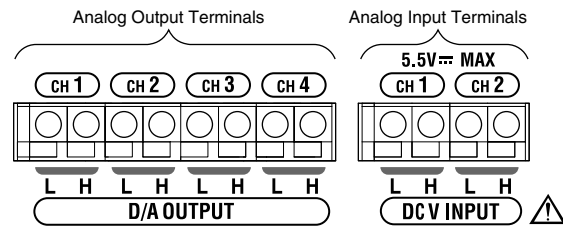

● Connection Method

<1>

Insert the signal line while pressing the rectangular portion at the bottom of the terminal with a flathead screwdriver, etc.

<2>

The signal line is secured when the screwdriver is removed.

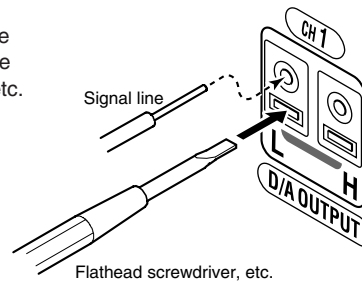

⚠ CAUTION

- The input circuit may be damaged if voltage exceeding the allowable input voltage range (-0.5 to 5.5 V) of the signal input terminal is input.
- Be careful not to mistake the input terminal and the output terminal when making connections.

● Usable Signal Lines

Suitable wiring : Solid wire $\phi 1.0$ (AWG18); Stranded wire 0.75 mm^2

Usable wiring : Solid wire $\phi 0.4$ to 1.0 (AWG26 18)

Stranded wire 0.3 to 0.75 mm^2 (AWG22 20)

Strand diameter $\phi 0.18$ or higher

Standard stripped wire length 10 mm

Chapter 14 Power Failure Processing Function

Chapter 14 Power Failure Processing Function

The CW240 includes a function for saving measurement data, setting values, etc., if the power supply provided to the CW240 is interrupted during integration measurement. The measurement data, setting values, etc., up to the point of interruption are saved.

The CW240 switches automatically to battery operation if an alkaline dry cell or a NiMH (nickel metal hydride) battery is installed.

● Saved Data

Set items are saved in the data save as indicated below.

- When the interval time is the standard interval (1 second to 60 minutes)
Mean value, minimum value, maximum value, electric energy, voltage fluctuation: The values immediately previous to the power failure.
Demand value: The demand value one previous from the time of power failure.
- When the interval time is a short interval (1 waveform to 500mS)
Mean value, minimum value, maximum value, electric energy, voltage fluctuation: The values 10 seconds previous to the power failure.
Demand value: The demand value one previous from the time of power failure.

● Operation after Power Recovery

Operation is as follows, according to the measurement status at the time of the power failure and the time of recovery.

Integration Measurement Power failure during standby	Recovery before integration measurement starts	Displays the message screen, and returns to standby. Starts integration measurement when the set time has been reached.
	Recovery after integration measurement start time has passed	Displays the message screen, and starts integration measurement immediately after power failure recovery.
Integration Measurement Power failure during integration	Saves the date and time of the power failure along with the measurement data from before the power failure, if the CW240 has been set to save to the PC card or the internal memory.	

● Message Display

The following message screen is displayed.

Measurement (internal operation) is continued even during message display.
Press any key to clear the message display.

● PC Card and Internal Memory Operation

<When power failure occurs while data is being saved (during media access)>
The save is canceled and the data is invalid. In the worst case, it is possible that the file will be damaged.

<When power failure occurs while data is not being saved>

When power is recovered, the time of power failure and the time of recovery are saved as indicated below, and operation is the same as that being performed before the power failure.

```
2003/06/27, 14:30:00, 00000:00:00, 0, 0.000E+00, .....  
2003/06/27, 14:31:00, 00000:01:00, 0, 0.000E+00, .....  
POWER OFF, 2003/6/27, 14:31:10, , , , ..... Power Failure Date and Time  
POWER ON, 2003/6/27, 14:31:20, , , , ..... Power Recovery Date and Time  
2003/06/27, 14:32:00, 00000:00:00, 0, 0.000E+00, .....  
2003/06/27, 14:33:00, 00000:01:00, 0, 0.000E+00, .....
```

 CAUTION

- Memory is accessed frequently when data is saved at a short interval time.
- The possibility that files will be destroyed rises when power failure occurs. If power failure is foreseen, it is recommended that an AC adapter and an alkaline dry cell or a NiMH (nickel metal hydride) battery be used together.

● Operation during Printing

<When the printer is operating with an AC adapter>

The printer does not operate when a power failure occurs. (Printing is stopped.)

<When the printer is operating with a battery>

Printing is continued during the time that CW240 is operating with a battery.

If CW240 stops operating, the data sent to the printer is printed (output), then printing stops.

Chapter 15 Other Functions

15.1 Holding the Display Value	15-2
15.2 Turning the LCD Backlight ON and OFF	15-3
15.3 Locking the Keys	15-4
15.4 Resetting the System.....	15-5

15.1 Holding the Display Value

The display screen (display values) are held when the F5 (HOLD) key is pressed during measurement.

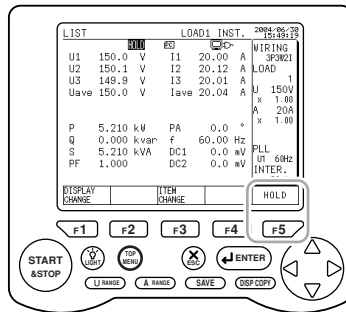

<Hold>

F5

Press the HOLD (F5) key.

The display screen is held.

HOLD is displayed at the top middle of the screen during the hold.

<Clear Hold>

F5

Press the HOLD (F5) key in hold status.

Hold will be cleared.

TIP

- Measurement (internal operation) is performed during hold.
- HOLD/CLEAR is displayed when integration data (integration values) has been saved. The integration values are cleared if the F5 key is pressed continuously for 3 seconds or longer.
- Setting confirmation cannot be performed during hold.
- When saving (printing) the screen with the DISP COPY key, it is recommended that the save (print) be done after holding the display value with the hold function.

15.2 Turning the LCD Backlight ON and OFF

● Turning the LCD Backlight ON

<Turning the light ON>



Press the LIGHT key.

The LCD backlight is lit.

The backlight will also be lit if the LIGHT key is pressed when the backlight has been turned off by the auto-off function.

<Turning the light OFF>

Press the LIGHT key when the light is ON.

The LCD backlight will go OFF.

● LCD Backlight Auto-off Function

This function automatically turns the LCD backlight OFF when there has been no key operation for 10 minutes or more while the LCD backlight is lit. (Set with hardware.)

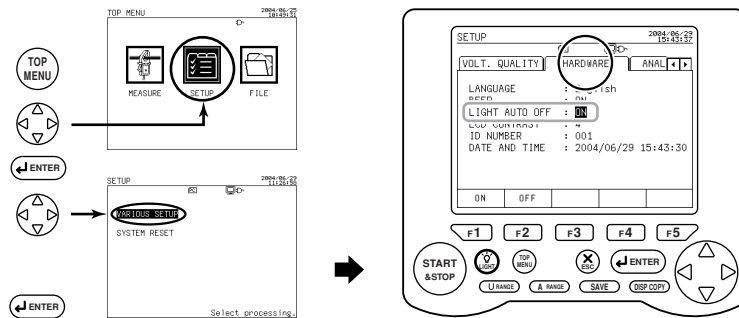

1 Displaying the Hardware screen



Using the right and left cursor keys, select the Hardware tab (highlighted).

Using the up and down cursor keys, select BACKLIGHT AUTO OFF.

2 Setup



Press the corresponding function key to activate/deactivate auto backlight OFF.

F1 : ON Activates auto backlight OFF if no key is pressed for more than 10 minutes.

F2 : OFF Lets the backlight remain ON.

15.3 Locking the Keys

The keys can be locked to prevent accidental operation during integration measurement, etc.

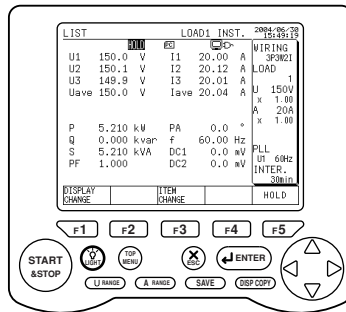

<Locking the keys>



Press the LIGHT key for 3 seconds or more.

The keys are locked.

 is displayed at the top middle of the screen while the keys are locked.

<Release>



Press the LIGHT key for 3 seconds or more.

The keys are unlocked.

TIP

The LIGHT key is available even when the keys are locked.

15.4 Resetting the System

System reset returns the setting conditions (setting values) to the factory settings.

The following setting items are not changed when system reset is executed.
Display language, ID number, date/time (clock), communication

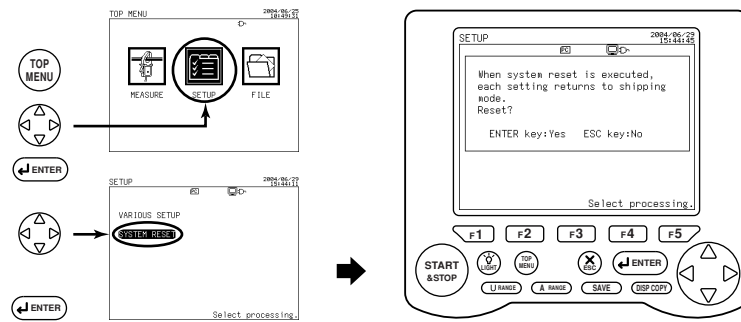

<System reset>

Confirmation message for system reset appears.

<End>

To reset the system	To cancel the system reset
Press the ENTER key. System reset begins. When system reset has been completed, the display returns to the top screen.	Press the ESC key. System reset is not performed, and the display returns to the top screen.

Chapter 16 Maintenance Troubleshooting

16.1 Things to Check When There is a Malfunction	16-2
16.2 Error Message Content and Actions	16-4

16.1 Things to Check When There is a Malfunction

This section describes how to handle problems that may arise with the CW240. If the CW240 does not operate correctly even after checking the items listed below, or if there is a problem not covered here, please contact a service representative listed on the back cover.

If an error message has been displayed on the display screen, refer to Section 16.2, Error Message Content and Actions.

Symptom	Things to Check	Reference Section
1) Nothing is displayed when the power switch is turned ON.	When using AC power <ul style="list-style-type: none"> • Confirm that the power cord is connected to the outlet correctly. 	3.2.1
	<ul style="list-style-type: none"> • Confirm that the power supply is within the allowable power supply voltage range. 	3.2.1
	When using battery power <ul style="list-style-type: none"> • Confirm that the battery case is correctly installed. 	3.2.2 3.2.3
	<ul style="list-style-type: none"> • If a NiMH battery pack is being used, confirm that the battery has been sufficiently charged. • If an alkaline dry cell is being used, confirm that the battery has not dissipated. (Confirm that the battery is installed with correct polarity.) 	3.2.3 3.2.2
2) Setting data is initialized when power is turned OFF	<ul style="list-style-type: none"> • If the opening messages "RTC Initialized" and "Settings Initialized" are displayed when power is turned ON, the backup battery has become dissipated. Backup batteries cannot be replaced by the customer. Contact a service representative. The lifetime of the backup battery is approximately 10 years. 	3.6
3) The measurement display value is incorrect.	<ul style="list-style-type: none"> • Check for the possibility of noise on the input signal. 	—
	<ul style="list-style-type: none"> • Confirm that the measurement probe and clamp are connected correctly. 	3.3 3.4
	<ul style="list-style-type: none"> • Confirm that the frequency measurement element has been set correctly. 	6.3.2 6.3.3
	<ul style="list-style-type: none"> • Confirm that the ambient temperature/humidity are within the specification's allowable range. 	4.2

16.1 Things to Check When There is a Malfunction

Symptom	Things to Check	Reference Section
4) Key operation cannot be done.	<ul style="list-style-type: none"> Confirm that key lock is not displayed at the upper right of the display area. 	15.3
5) Saving and writing to internal memory cannot be done.	<ul style="list-style-type: none"> Turn the power OFF then ON again. The problem may be resolved in the opening self-test. 	3.6
	<ul style="list-style-type: none"> It is possible that a power supply error, etc., occurred while the internal memory was being accessed. Format the internal memory in the file processing mode. Data saved in the internal memory will be lost. 	9.4
6) Saving and writing to the PC card cannot be done.	<ul style="list-style-type: none"> Confirm that the PC card has been inserted correctly. 	11.2
	<ul style="list-style-type: none"> Confirm that the PC card has been formatted. 	9.4
	<ul style="list-style-type: none"> Confirm that the capacity of the PC card has not been exceeded. 	11
7) Communication cannot be done through the RS-232 interface.	<ul style="list-style-type: none"> Confirm that the communication parameters of the CW240 and the controller, etc., match. 	6.6
	<ul style="list-style-type: none"> Confirm that the specifications of the cables connecting the CW240 and the controller, etc., are suitable for the purpose. 	10.2
8) Printing cannot be done.	<ul style="list-style-type: none"> Confirm that printer power is ON. (Refer to the printer's instruction manual.) 	10.3
	<ul style="list-style-type: none"> Confirm that connection cable specifications match. 	10.3
	<ul style="list-style-type: none"> Confirm that the frequency measurement element has been set correctly. 	10.3
	<ul style="list-style-type: none"> Confirm that the communication parameters of this device and the printer match. 	10.3
	<ul style="list-style-type: none"> Confirm that the print media has been set correctly. 	—
9) An error occurs in the opening message. Measurement or Top menu screen does not display.	<ul style="list-style-type: none"> This is a hardware error. Contact a service representative. 	3.6

16.2 Error Message Content and Actions

Messages are sometimes displayed on the screen while this device is being used. The content and actions are described here.

16.2.1 Execution Errors

● Confirmation Messages

Message	Content/Action
Same file name already exists. Overwrite?	The same file name already exists. Select whether to overwrite or not.

● Normal Messages

Message	Content/Action
Cannot change name of file.	The selected file is read-only.
Cannot delete file.	Change it to full-access.
Same file name already exists. Cannot change.	The new file name in file name change operation already exists. Change the new file name.
Error has occurred during writing Internal memory.	Check the internal memory.
Error has occurred during writing PC card.	Check the PC card.
Error has occurred during print out.	Check the printer.
Error has occurred during reading Internal memory	Check the internal memory.
Error has occurred during reading PC card.	Check the PC card.
PC card not yet formatted. Format it.	Format the PC card to MS-DOS format.
PC card not inserted.	Insert the PC card correctly.
Write-protect is performed.	Clear the write-protect on the storage media.
No file.	There is no file to read. The operation is invalid.
File not yet selected.	No file is selected in file deletion or file copying. Select a file.

16.2 Error Message Content and Actions

Message	Content/Action
Maximum number in PC card exceeded.	The number of saved files has exceeded 30. Delete unnecessary files from the PC card.
PC card exceeds the capacity.	Delete unnecessary files from the PC card.
Not flash ATA card.	The inserted PC card is not flash ATA. Insert a flash ATA memory card.
PC card not supported.	An unsupported flash ATA memory card has been inserted. Insert a supported card.
Error relating to the PC card has occurred.	A PC card-related error other than the above has occurred. Check the PC card.
Maximum number in setting file exceeded.	The number of saved setting files has exceeded 30 (5 in the case of internal memory). Delete unnecessary files.
Internal memory exceeds capacity.	The capacity of the internal memory has been reached. Delete unnecessary files.
Maximum number in internal memory exceeded.	The number of files saved in the internal memory has exceeded 30. Delete unnecessary files.
Failure in saving data within output interval time.	It becomes easy for this problem to occur when there are many files in the save destination or when the file capacity is large. Check the save destination memory.
Start time has passed. Start Integration measurement by JUST start.	The START&STOP key was pressed after the set start time had passed. Start integration measurement with JUST start.
Stop time is over. End measurement by hand.	The START&STOP key was pressed after the set stop time had passed. Start integration measurement. Also, stopping is done manually. Press the START&STOP key to stop integration measurement.
Invalid key operation during integration measurement.	The SAVE key or the DISP COPY key was pressed during integration measurement. Perform saves and screen copies after integration measurement has ended.
No saved data in backup memory.	Backup memory copy or backup memory delete was selected when there is no data saved in the backup memory. This operation is not required.
Backup memory exceeds capacity.	The backup memory is full. Delete data from the backup memory.
Correct wiring.	Confirm that connections have been made correctly, using Scott connection confirmation.
1P3W load connection is different from setting. It may connect to R-S (example). Check setup of 1P3W load Connection.	It is possible that Scott connection confirmation is not correct. Check the connections and the CW240 settings.

16.2 Error Message Content and Actions

16.2.2 Setting Errors

● Normal Messages

Message	Content/Action
Product of [rated power×VT ratio×CT ratio×1.3] exceeds 999.9TW.	Change the wiring, voltage range, current range, VT ratio, CT ratio, or clamp settings.
Harmonics measurement data preservation and printer output cannot be performed.	Harmonic measurement data save and print output cannot be done at 30 seconds or less at the standard interval. To print out or save harmonic measurement data during integration measurement, set the interval time to 1 minute or more.
Only the instant value of normal measurement is saved in binary type.	Data saves when the interval is short is limited to binary-type normal measurement instant values.

16.2.3 Various Messages

● Confirmation Messages

Message	Content/Action
When system reset is executed, each setting returns to shipping mode. Reset?	Confirmation when executing system reset.
Stop integration measurement?	Confirmation when forcing integration measurement to end.
Measurement data will be cleared. Proceed?	Confirmation when clearing integration measurement data.
Delete is performed. Proceed?	Confirmation when deleting files.
Format is performed. Proceed?	Confirmation when formatting.
Copy is performed. Proceed?	Confirmation when copying data.
Saved data in backup memory is copied to PC card. Proceed?	Confirmation when copying the backup memory.
Saved data in backup memory is deleted. Proceed?	Confirmation when deleting the backup memory.

16.2 Error Message Content and Actions

● Normal Messages

Message	Content/Action
Inserted new PC card.	Displayed when saving data to the backup memory, when a new PC card has been inserted.
Saved data in backup memory was copied to PC card.	Displayed when saving data to the backup memory, when a new PC card has been inserted and integration measurement has ended.
POWER OFF TIME: 2004/01/01 00:00:00 POWER ON TIME: 2004/01/01 00:00:00	Displayed after power failure recovery.
Processing. Please wait.	Displayed during processing.

Chapter 17 CW 240 Specifications

17.1 CW 240 Specifications	17-2
17.2 Specifications of Current Clamps (Clamp-on Probe)	17-17

17.1 CW 240 Specifications

(1) Input

Item	Voltage	Current
Input Form	Resistance Partial Pressure Method	Clamp Detection Method
Rated Value (Range)	150.0 V 300.0 V 600.0 V 1000 V	According to the clamp used and the range. 96036 (2A) 200.0/500.0mA/1.000/2.000A 96033 (50A) 5.000/10.00/20.00/50.00 A 96030 (200A) 20.00/50.00/100.0/200.0 A 96031 (500A) 50.00/100.0/200.0/500.0 A 96032 (1000A) 200.0/500.0 A/1.000 kA 96034 3000A range 300.0/750.0 A/1.500/3.000 kA 2000A range 200.0/500.0 A/1.000/2.000 kA 1000A range 100.0/200.0/500.0 A/1.000 kA 96035 3000A range 300.0/750.0 A/1.500/3.000 kA 300A range 30.00/75.00/150.0/300.0 A
Measurement Wiring	Single phase 2 wire, single phase 3 wire, single phase 3 wire 3 current (neutral line current), 3 phase 3 wire 2 current (2 power-meter method), 3 phase 3 wire 3 current (3 power-meter method), 3 phase 4 wire, 3 phase 4 wire 4 current (neutral line current), Scott connection (3 phase 3 wire + single phase 3 wire)	
Measurement Line Quantity (Number of loads)	Common Voltage Single phase 2 wire: 4 loads; single phase 3 wire: 2 loads; 3 phase 3 wire 2 current: 2 loads	
Input Resistance	Approx. 13MΩ	Approx. 100kΩ (CW240 main unit)
Continuous Maximum Allowable Input	1000 Vrms	96036 (2A) 20Arms 96033 (50A) 130Arms 96030 (200A) 250Arms 96031 (500A) 625Arms 96032 (1000A) 700Arms 96034 3000A range 2400Arms 2000A range 2400Arms 1000A range 1200Arms 96035 3000A range 3600Arms 300A range 360Arms
AD Converter	Voltage: Current Input Simultaneous Conversion PLL Synchronization 128 samples/cycle 16-bit resolution	

(2) Measurement Functions

Item	Voltage	Current/Active Power/Reactive Power 1 (using the reactive power method)
Method	Digital Sampling Method	
Frequency Range	45 to 65 Hz (The measurement element is selected from U1, U2, and U3.)	
Crest Factor	3 at rated input (1.8 at 1000V range)	
Accuracy	±0.2%rdg. ±0.1%rng.	96030, 96031,96033,96036 ±0.6%rdg.±0.4%rng. 96032,96034,96035 ±1.0%rdg.±0.8%rng.
Power Factor Effects	—	96030 ±1.0%rng.(45 to 65Hz,power factor =±0.5) Excluding 96030 ±2.0%rng.(45 to 65Hz,power factor=±0.5)
Reactive Factor Effects	—	96030 ±1.0%rng.(45 to 65Hz,reactive factor=±0.5) Excluding 96030 ±2.0%rng.(45 to 65Hz,reactive factor=±0.5)
Available Input Range	5 to 110% of each range (The upper limit at 1000V range is 100%.)	
Display Range	Voltage: 0.4 to 130% of each range (zero suppression for under 0.4%) Electric Power (active, reactive, apparent): 0 to 130% of each range (zero suppression for 0.17% or less of the range rating) Harmonics Level: 0 to 130% of each range Frequency:	
Temperature Coefficient	±0.03%rng/°C	±0.05%rng/°C
Display Update Cycle	Approx. 0.5 seconds	

rdg: reading; rng: range

(3) Equations

Voltage RMS Value
$$U_{rms} = \sqrt{\frac{1}{T} \int_0^T u_m(t)^2 dt} = \sqrt{\frac{1}{T} \sum_{m=0}^T u_m(t)^2}$$

Current RMS Value
$$I_{rms} = \sqrt{\frac{1}{T} \int_0^T i_m(t)^2 dt} = \sqrt{\frac{1}{T} \sum_{m=0}^T i_m(t)^2}$$

Active Power
$$P_m = \frac{1}{T} \int_0^T \{u_m(t) \times i_m(t)\} dt = \frac{1}{T} \sum_{m=0}^T \{u_m(t) \times i_m(t)\}$$

Reactive Power1: When using the reactive power method

$$Q_m = \frac{1}{T} \int_0^T \{u_m(t) \times i_m(t + \frac{T}{4})\} dt = \frac{1}{T} \sum_{m=0}^T \{u_m(t) \times i_m(t + \frac{T}{4})\}$$

where

- u(t) : Voltage Input Signal
- i(t) : Current Input Signal
- T : Input Signal 1 Cycle
- m : Phase

17.1 CW 240 Specifications

Formula for Each Wiring

Wiring Measurement Item	Equations	Symbol	Single Phase 3 Wire
Average Voltage	–	Uave	$(U1+U2) / 2$
Average Current	–	Iave	$(I1+I2) / 2$
Active Power	–	ΣP	$P1+P2$
Reactive Power ² 4	$Q = \sqrt{S^2 - P^2}$	ΣQ	$Q1+Q2$
Apparent Power	$S = U \times I$	ΣS	$S1+ S2$
Power Factor	Reactive power method not used ⁶	ΣPF	$\Sigma PF = \frac{\Sigma P}{\Sigma S}$
	Reactive power method used	ΣPF	$\Sigma PF = \frac{\Sigma P}{\sqrt{\Sigma P^2 + \Sigma Q^2}}$
Phase Angle ⁶	–	ΣPA	$\Sigma PA = \cos^{-1} \Sigma PF$

Wiring Measurement Item	Equations	Symbol	3 Phase 3 Wire 2 Current ⁷
Average Voltage	–	Uave	$(U1+U2+U3) / 3$
Average Current	–	Iave	$(I1+I2+I3) / 3$ ²
Active Power	–	ΣP	$P1+P3$
Reactive Power ² 4	$Q = \sqrt{S^2 - P^2}$	ΣQ	$\sqrt{\Sigma S^2 - \Sigma P^2}$
Apparent Power	$S = U \times I$	ΣS	$\frac{\sqrt{3}}{2} (S1+S3)$
Power Factor	Reactive power method not used ⁶	ΣPF	$\Sigma PF = \frac{\Sigma P}{\Sigma S}$
	Reactive power method used	ΣPF	$\Sigma PF = \frac{\Sigma P}{\sqrt{\Sigma P^2 + \Sigma Q^2}}$
Phase Angle ⁶	–	ΣPA	$\Sigma PA = \cos^{-1} \Sigma PF$

17.1 CW 240 Specifications

Wiring Measurement Item	Equations	Symbol	3 Phase 3 Wire 3 Current	3 Phase 4 Wire
Average Voltage	–	Uave	$(U_1+U_2+U_3) / 3$	
Average Current	–	Iave	$(I_1 + I_2 + I_3) / 3$	
Active Power	–	ΣP	$P_1+P_2+P_3$	
Reactive Power ^{2,4}	$Q = \sqrt{S^2 - P^2}$	ΣQ	$Q_1+Q_2+Q_3$	
Apparent Power	$S = U \times I$	ΣS	$S_1+S_2+S_3$	
Power Factor	Reactive power method not used ⁶	ΣPF	$\Sigma PF = \frac{\Sigma P}{\Sigma S}$	
	Reactive power method used	ΣPF	$\Sigma PF = \frac{\Sigma P}{\sqrt{\Sigma P^2 + \Sigma Q^2}}$	
Phase Angle ⁶	–	ΣPA	$\Sigma PA = \cos^{-1} \Sigma PF$	

*1: In the case of distorted wave input, there may be a difference with other measuring devices that use a different measurement principle.

*2: Line voltage for 3 phase 3 wire, and phase voltage for 3 phase 4 wire.

*3: I2 for 3 phase 3 wire (2 power-meter method) is the result calculated through vector operation.

*4: When not using the reactive power method. Even in this case, the operation is performed by multiplying the polarity of Q of each phase calculated with the reactive power method.

*5: For 3 phase 3 wire, the voltage used when obtaining the electric power of each phase is the phase voltage from the virtual neutral point.

*6: The operation is performed by multiplying the polarity of Q of each phase calculated with the reactive power method.

*7: In the case of unbalanced input with 3 phase 3 wire (2 power-meter method), there may be a difference with other connections or measuring devices that use a different measurement principle.

P1, P3, Q1, Q3, S1, S3, PF1, and PF3 have not physical meaning as values in the operation process of the 2 power-meter method.

TIP

The active power, reactive power, apparent power, power factor, and phase angle measure the value of each phase.

(4) Function Specifications

● **Frequency Measurement Function**

Measurement Input	Voltage Input Select from U1, U2, and U3.
Measurement Frequency Range	45 to 65 Hz
Display Range	40.00 to 70.00 Hz
Accuracy	±0.1% rdg. ±1 dgt. Upon 10 to 130% sine wave input of the voltage range
Low-pass Filter Function	Cutoff Frequency Approx. 300Hz ON/OFF can be set

● **Electric Energy Measurement Function**

Measurement Elements	Electric energy, regenerative energy, lagging reactive energy, leading reactive energy				
Measurement Accuracy	Active power, reactive power measurement accuracy ±1 dgt. (When the display digit setting is STANDARD.)				
Measurement Range	Electric energy				
<table border="0"> <tr> <td rowspan="3" style="font-size: 2em; vertical-align: middle;">}</td> <td style="padding: 0 5px;">Range, VT Ratio, CT Ratio</td> </tr> <tr> <td style="padding: 0 5px;">According to Display</td> </tr> <tr> <td style="padding: 0 5px;">Digits Setting</td> </tr> </table>	}	Range, VT Ratio, CT Ratio	According to Display	Digits Setting	Consumed: 0.00000 mWh to 999999 GWh Regenerative: -0.00000 mWh to -999999 GWh
		}	Range, VT Ratio, CT Ratio		
			According to Display		
Digits Setting					
	Reactive energy				
	Lagging: 0.00000 mvarh to 999999 Gvarh Leading: -0.00000 mvarh to -999999 Gvarh				
Display Digit Design Function	Select from the minimum resolution shift through integration value, minimum resolution setting, and automatic setting according to the rated power.				
Integration Time Accuracy	±20 ppm (Typ., 23°C)				

● **Demand Measurement Function**

Measurement Elements	Active power (consumed), reactive power (lagging), power factor: Demand value within the interval time Electric energy (consumed, regenerative), Regenerative energy (lagging, leading): Demand value within the interval time Maximum demand value (power consumption demand) from the start of integration measurement and the time of occurrence
Measurement Accuracy	Active power, reactive power measurement accuracy ±1 dgt. (When the display digit setting is STANDARD.)

● Harmonic Measurement Function

Method	PLL synchronization method
Measurement Frequency Range	Fundamental wave frequency: 45 to 65 Hz
Analysis Order	1st to 50th order
Window Width	1 cycle
Window Type	Rectangular
Analysis Data Quantity	128 points
Analysis Rate	1 time/16 cycles
Analysis Items	Harmonic level: Harmonic level of each order of voltage/current/electric power Harmonic content: Harmonic content of each order of voltage/current/electric power Harmonic phase angle: Harmonic phase angle of each order of voltage/current/electric power Select for the fundamental wave or the fundamental wave for U1 for the voltage and current. Total value: The total value up to the 50th Order of voltage/current/electric power/power factor Total harmonic distortion ratio: Voltage/current (THD-F or THD-R)
Accuracy	Harmonic level 1st to 20th order : $\pm 1.5\%$ rdg. $\pm 1.5\%$ rng. 21st to 30th order: $\pm 2.0\%$ rdg. $\pm 1.5\%$ rng. 31st to 50th order: $\pm 3.0\%$ rdg. $\pm 1.5\%$ rng. Harmonic content (value calculated from the harmonic level) ± 2 dgt. Harmonic phase angle The guaranteed accuracy range is 5% or more of the range for both the current level and the harmonic voltage of each order. 1st to 20th order: $\pm 5^\circ$ 20th to 50th order: $\pm (0.3^\circ \times k + 1^\circ)k$: order The fundamental wave for current is not specified.
	$\left. \begin{array}{l} \text{Current, Electric Power} \\ \text{16}^{\text{th}} \text{ order and after of 96031,} \\ \text{total order of 96032 are} \\ \text{reference values} \end{array} \right\}$
Display Data	List, bar graph (linear or log), vector

17.1 CW 240 Specifications

Harmonic Measurement Basic Equations

Measurement Item	Equations
Voltage RMS Value Current RMS Value	$U_n = \sqrt{\frac{(U_{nr})^2 + (U_{ni})^2}{2}} \quad I_n = \sqrt{\frac{(I_{nr})^2 + (I_{ni})^2}{2}}$
RMS Value nth Order Content	$\frac{\text{nth order rms value}}{\text{fundamental wave rms value}} \times 100\%$
RMS Value Phase Angle (Fundamental Wave Standard)	$\theta U_n = (\text{nth order harmonic voltage phase}) - (\text{fundamental wave phase}) \times n$ $= \tan^{-1} \left(\frac{U_{nr}}{U_{ni}} \right) - \left\{ \tan^{-1} \left(\frac{U_{1r}}{U_{1i}} \right) \right\} \times n$ $\theta I_n = (\text{nth order harmonic current phase}) - (\text{fundamental wave phase}) \times n$ $= \tan^{-1} \left(\frac{I_{nr}}{I_{ni}} \right) - \left\{ \tan^{-1} \left(\frac{I_{1r}}{I_{1i}} \right) \right\} \times n$
RMS Value Phase Angle (U1 Standard)	$\theta U_n = (\text{nth order harmonic voltage phase})$ $= \tan^{-1} \left(\frac{U_{nr}}{U_{ni}} \right)$ $\theta I_n = (\text{nth order harmonic current phase})$ $= \tan^{-1} \left(\frac{I_{nr}}{I_{ni}} \right)$
Total Harmonic Distortion Ratio (Fundamental Wave Standard)	$THD-F = \sqrt{\frac{\sum_{n=2}^{50} (\text{nth order harmonic voltage (current) rms value})^2}{(\text{fundamental wave voltage (current) rms value})^2}}$
Total Harmonic Distortion Ratio (Total RMS Value Standard)	$THD-R = \sqrt{\frac{\sum_{n=2}^{50} (\text{nth order harmonic voltage (current) rms value})^2}{\sum_{n=1}^{50} (\text{nth order harmonic voltage (current) rms value})^2}}$

17.1 CW 240 Specifications

Measurement Item	Equations
Electric Power	$P_n = U_{nr} \times I_{nr} + U_{ni} \times I_{ni}$
Electric Power nth Order Content	$\frac{\text{nth order active power}}{\text{fundamental wave active power}} \times 100\%$
Total RMS Value	$\sum U = \sqrt{\sum_{n=1}^{50} U_n^2}$ $\sum I = \sqrt{\sum_{n=1}^{50} I_n^2}$
Total Electric Power Value	$\sum P = \sum_{n=1}^{50} P_n$
Total Power Factor	<p>Not using the reactive power method</p> $\frac{\sum P}{\sum U \times \sum I}$ <p>Using the reactive power method</p> $\frac{\sum_{n=1}^{50} P_n}{\sqrt{\left(\sum_{n=1}^{50} P_n\right)^2 + \left(\sum_{n=1}^{50} Q_n\right)^2}}$

Harmonic Equations for Each Wiring

Wiring	Single Phase 2 Wire	Single Phase 3 Wire
Measurement Item		
Voltage RMS Value	$U1n$	$U1n$ $U2n$
Current RMS Value	$I1n$	$I1n$ $I2n$ $I3n$ (When using 3 current)
Electric Power	$P_n = U_{nr} \times I_{nr} + U_{ni} \times I_{ni}$	$P_n = P1n + P2n$
Reactive Power **1	$Q_n = U_{nr} \times I_{ni} - U_{ni} \times I_{nr}$	$Q_n = Q1n + Q2n$
Apparent Power **1	$S_n = U_n \times I_n$	$S_n = S1n + S2n$

17.1 CW 240 Specifications

Measurement Item	3 Phase 3 Wire 2 Current
Voltage RMS Value	U_{1n} U_{2n} (Calculated as $U_2 = u_3(t)$) U_{3n} (Calculated as $U_3 = u_1(t) - u_3(t)$)
Current RMS Value	I_{1n} I_{2n} (Calculated as $I_2 = i_1(t) - i_3(t)$) I_{3n}
Electric Power	$P_n = P_{1n} + P_{3n}$ ($P_{3n} = U_{2r} \times I_{3r} + U_{2i} \times I_{3i}$)
Reactive Power *1	$Q_n = Q_{1n} + Q_{3n}$ ($Q_{3n} = U_{2r} \times I_{3r} + U_{2i} \times I_{3i}$)
Apparent Power *1	$\frac{\sqrt{3}}{2} (S_{1n} + S_{3n})$

Wiring	3 Phase 3 Wire 3 Current	3 Phase 4 Wire
Measurement Item		
Voltage RMS Value	U_{1n} (Calculated as $U_1 = u_1(t) - u_2(t)$) U_{2n} (Calculated as $U_2 = u_2(t) - u_3(t)$) U_{3n} (Calculated as $U_3 = u_3(t) - u_1(t)$) $u_n(t)$: Phase voltage from hypothetical midpoint	U_{1n} U_{2n} U_{3n} Phase voltage
Current RMS Value	I_{1n} I_{2n} I_{3n} I_{4n} (When using 4 current)	
Electric Power	$P_n = P_{1n} + P_{2n} + P_{3n}$	
Reactive Power *1	$Q_n = Q_{1n} + Q_{2n} + Q_{3n}$	
Apparent Power *1	$S_n = S_{1n} + S_{2n} + S_{3n}$	

By performing FFT operation on the 128 sample data that was taken in, nth order harmonics are broken down into elements as follows.

nth Order Harmonic Voltage RMS Value $U_n : (U_{nr}, U_{ni})$

nth Order Harmonic Current RMS Value $I_n : (I_{nr}, I_{ni})$

n : order

U_{nr}, I_{nr} : real number elements after FFT operation

U_{ni}, I_{ni} : imaginary number elements after FFT operation

P_{1n}, P_{2n}, P_{3n} : active power (each element of the nth order)

Q_{1n}, Q_{2n}, Q_{3n} : reactive power (each element of the nth order)

$u_m(t), i_m(t)$: vector

RMS Value Phase Angle: phase angle of the nth order harmonic element for the fundamental wave element of the input signal

Electric Power Value Phase Angle:

phase of the current of the nth order for the voltage of the nth order

*1: Internal operation for use in power factor electric power phase angle and power factor computation.

● **Waveform Measurement Function**

Measurement Elements	Select from in-phase voltage/current waveform, all-voltage waveform, and all-current waveform.
Magnification Change	1/3 to 20 times the rating
Display Data	1 waveform

● **Voltage Fluctuation (Quality) Measurement Function**

Measurement Elements	Voltage dip, voltage swell, instantaneous voltage interruption
Measurement Method	Detected from the voltage rms value of one waveform
Threshold/Hysteresis	Set by a percentage of the standard voltage
Accuracy	Same as the voltage rms value accuracy
Detection Interval	Interval during which the threshold value was exceeded
Display Data	Date/time of occurrence, voltage rms value, detection interval
Event Quantity	100

● **Display Function**

Indicator	5.7 inch STN monochrome liquid crystal display (320 x 240 pixels) with backlight
Backlight	ON/OFF, auto-off settings
Contrast	8-level setting and auto-correction according to ambient temperature
Display Digits	Other than electric energy: 4 digits Electric energy: 6 digits
Language Switch	Japanese/English
Display Average Function	Moving average method Select from 1, 2, 5, 10, or 20 times.
Display Hold	Hold/Cancel

17.1 CW 240 Specifications

● Save/Print Function

Manual or Automatic Save/Print

Storage Media

Internal memory: 1 MB or PC card

Printing

Dedicated printer (RS-232 connection)

Save/Print Data

Measurement data, voltage fluctuation data, waveform data, screen data, setting data

Save/Print Interval

Standard Interval

1/2/5/10/15/30 seconds,
1/2/5/10/15/30/60 minutes

Harmonic measurement, waveform data output, and printing are not available at 30 seconds or less.

Short Interval

one wave/100/200/500 msec

Data output items are instantaneous value only.

● Data Savable Time Display

Calculated according to the available capacity of the save destination, data save item, and interval time.

● File Handling

File Copy

Copy files from internal memory to the PC card.

Setting File Read/Save (Write)

Internal memory, PC card setting file read/save

File Delete

Internal setting file delete, PC card file delete

Format

PC card, internal memory initialization

Save Format

Measurement Data: CSV format (binary format when short interval is set.)

Voltage Fluctuation Data: Text format

Waveform Data: Binary format

Screen Data: BMP format (bitmap)

Setting Data: Text format

● Clock Function

Auto-calendar, automatic leap year differentiation, 24-hour clock

Real Time Accuracy

± 20 ppm (Typ., 23° C)

● **Connection Confirmation (Wiring Check) Function**

Confirms voltage/current input values, voltage/current phase difference, voltage-to-voltage phase difference, current-to-current phase difference, suitability of frequency measurement.

For Scott connections, confirms single-phase load connection.

Wiring diagram, vector diagram display

● **Setting Confirmation (Setting Check) Screen**

Screen for confirming integration measurement data save items, start/end, etc.

● **Other Functions**

VT ratio/CT ratio setting, ID number setting, NiMH (nickel metal hydride) battery charge, battery residual quantity display, beep (key operation confirmation), key lock, system reset

(5) Communication Function

Electrical Specifications	E1A RS-232
Synchronization Method	Start/stop synchronization
Baud Rate	1200/2400/9600/19200/38400 bps
Connectors	D-SUB 9 pin

(6) PC Card Interface

Slot	"PC Card Standard" conforming TYPE II × 1 set
Usable Cards	Flash ATA card
Data Format	MS-DOS format
Storage Content	Setting data, measurement data, screen data

(7) External Control Input/Output

Integration measurement start/end control input/output	
Control Input	TTL level or contact point
Control Output	TTL level

(8) Analog Input and DA Output Function (Optional)

● **DA Output**

Output Voltage	±1 V DC for each range of the rated value Electric energy depends on output rate. Magnification of 1, 10, or 100 can be set for harmonics. Frequency is (0.4 to 0.7 V)/(40 to 70 Hz)
Output Quantity	4CH
Output Data (Select 4 items)	Instantaneous value Voltage, current, average voltage, average current, active power, reactive power, apparent power, power factor, phase angle, frequency Electric energy Electric energy (consumed/regenerative), reactive energy (lagging/leading) Harmonics Level, content, phase angle, total value, THD (THD-F/THD-R)
Accuracy	± (measurement accuracy + 0.2%f.s.)
Resolution	Polarity + 11 bits
Update Interval	Other than harmonic measurement: 1 input signal cycle Harmonic measurement elements: 16 input signal cycles
Temperature Coefficient	±0.02% f.s./°C or less
Output Resistance	22 Ω ±5%
Electric Energy Output Rate	Select from 1 V/1 kWh, 1 V/5 kWh, 1 V/10 kWh, 1 V/50 kWh, 1 V/100 kWh, 1 V/500 kWh, and 1 V/1000 kWh

● **Analog Input**

Input Range	100 mV/1 V/5 V DC
Input Quantity	2CH
Accuracy	±0.5% f.s.
Resolution	Polarity + 11 bits
Sample Rate	Approx. 20 msec
Input Resistance	Approx. 100 kΩ

(9) General Specifications

Location of Use	Indoors, up to an altitude of 2000m
Storage Temperature/Humidity Range	-20 to 60°C, 90% R.H. or less (no condensation)
Operating Temperature/Humidity Range	5 to 40°C, 5 to 80% R.H. or less (no condensation)
Insulation Resistance	500 V DC, 50 MW or higher Between the voltage input terminal and the main unit case Between the voltage input terminal and the current input terminal/DC power supply terminal/external interface terminal
Breakdown Voltage (50/60Hz, 1 minute)	5.55 kVrms AC/1 minute interval (sensitivity current 1 mA) Between the voltage input terminal and the main unit case 3.32 kVrms AC /1 minute interval (sensitivity current 1 mA) Between the voltage input terminal and the current input terminal/DC power supply terminal/external interface terminal
Power Supply	Dedicated adapter (included) 100 to 240 V AC, 50/60 Hz
Power Failure Backup	Battery 6 size AA alkaline dry cells (included)
Power Supply	NiMH battery (sold separately)
Maximum Rated Power	Main Unit: Approx. 10 W (during normal operation), approx. 20 W (during NiMH charge) AC Adapter: Approx. 30 VA (during normal operation), approx. 60 VA (during NiMH charge)
Dimensions	Approx. 206 (W) × 184 (H) × 65 (D) mm (excluding protruding parts)
Weight	Approx. 1.2 kg (excluding battery)
● Accuracy Guarantee Conditions	
Warm-up Time	30 minutes or more, at available input range, sine wave input, power factor = 1, with PLL synchronization
Accuracy Guarantee Temperature/Humidity Range	23 ±5°C, 30 to 75% R.H. or less
Accuracy Guarantee Frequency Range	45 to 65 Hz
Accuracy Guarantee Period	1 year

17.1 CW 240 Specifications

● Accessories

1. AC Adapter	1
2. AA-size alkaline batteries	6
3. Voltage Probe (Model: 91007) (black, red, yellow, blue, 1 each; cord length: 3 m)	1 set
4. User's Manual	1
5. Quick setup Manual	1
6. CD-ROM	1

CD-ROM Contents

- User's Manual
- Quick setup Manual
- Communication Function Manual
- ToolBox240 (setup and data conversion software)

17.2 Specifications of Current Clamps (Clamp-on Probe)

Dimensions of Model 96036

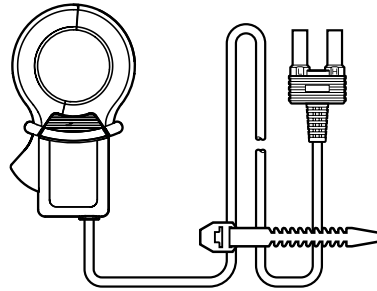

Dimensions of Model 96033

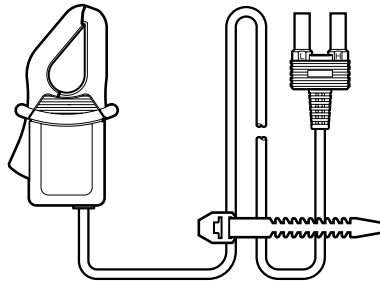

Item	96036	96033
Measurable conductor diameter	ø 40mm max.	ø 18mm max.
Measurement range	0-2A AC	0-50A AC
Output voltage	0-50mV AC	0-500mV AC
Accuracy ^{*1)}	Amplitude	±0.5% of rdg. ±0.1mV (45 to 66 Hz)
	Phase	Within ±2.0°
Maximum allowable current ^{*1)}	20A AC (45 Hz to 3.5 kHz)	130A AC (45 Hz to 1 kHz)
Frequency range	20 Hz to 5 kHz	20 Hz to 20 kHz
Maximum applicable circuit voltage	50V AC	300V AC
External dimensions (W)×(H)×(D)	Approx.70mm×120mm×25mm	Approx.52mm×106mm×25mm
Weight	Approx.300g	Approx.220g

*1) Varies depending on the input level and frequency. For detailed specifications, refer to the Users Manual that comes with the clamp-on power meter.

17.2 Specifications of Current Clamps

Dimensions of Model 96030/96031

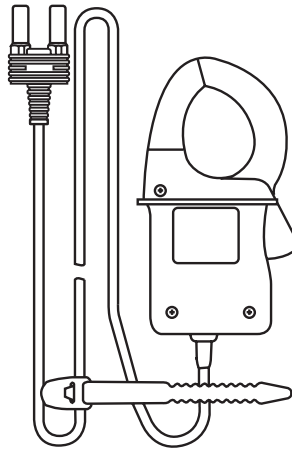

Item	96030	96031
Measurable conductor diameter	ø 30mm max.	ø 30mm max.
Measurement range	0-200A AC	0-500A AC
Output voltage	0-500mV AC	0-500mV AC
Accuracy ^{*1)}	Amplitude	±0.5% of rdg. ±0.1mV (45 to 66 Hz)
	Phase	Within ±0.5°
Maximum allowable current ^{*1)}	250A AC (45 Hz to 1 kHz)	625A AC (45 Hz to 400Hz)
Frequency range	20 Hz to 20 kHz	20 Hz to 5 kHz
Maximum applicable circuit voltage	600V AC	600V AC
External dimensions (W)×(H)×(D)	Approx.73mm×130mm×30mm	Approx.73mm×130mm×30mm
Weight	Approx.300g	Approx.300g

^{*1)} Varies depending on the input level and frequency. For detailed specifications, refer to the Users Manual that comes with the clamp-on power meter.

17.2 Specifications of Current Clamps

Dimensions of Model 96032

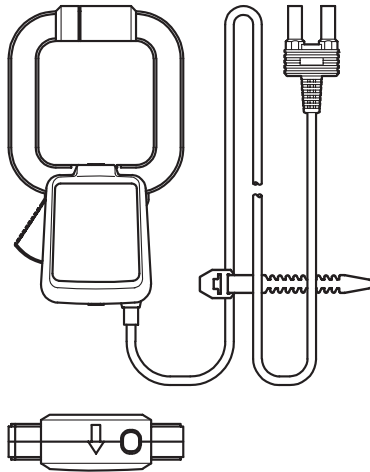

Dimensions of Model 96034

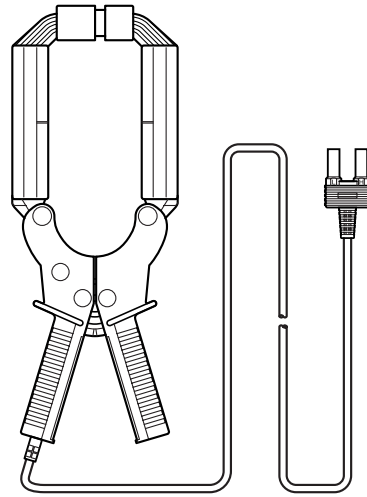

Item	96032	96034
Measurable conductor diameter	ø 65mm max.	65×100mm max.
Measurement range	0-700A AC	0-1000/2000/3000A AC
Output voltage	0-500mV AC	0-500mV AC
Accuracy ^{*1)}	Amplitude	±1.0% of rdg. ±0.2mV (45 to 66 Hz)
	Phase	Within ±1.0°
Maximum allowable current ^{*1)}	1000A AC (5 minutes) (45 Hz to 66 Hz)	2400A AC 3600A AC (10 minutes)
Frequency range	45 Hz to 66 Hz	30 Hz to 1.5 kHz
Maximum applicable circuit voltage	600V AC	600V AC
External dimensions (W)×(H)×(D)	Approx.100mm×172.5mm×32mm	Approx.120mm×310mm×48mm
Weight	Approx.500g	Approx.1,390g

*1) Varies depending on the input level and frequency. For detailed specifications, refer to the Users Manual that comes with the clamp-on power meter.

17.2 Specifications of Current Clamps

Dimensions of Model 96035

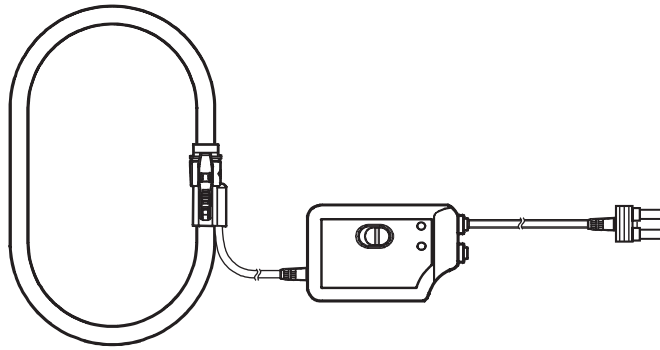

Item		96035
Measurable conductor diameter		ø 170mm max.
Measurement range		0-300/3000A AC
Output voltage		0-500mV
Accuracy ^{*1)}	Amplitude	±1.0% of rdg. (45 to 66 Hz)
	Phase	Within ±1.0°
Maximum allowable current ^{*1)}		3600A AC (10 Hz to 1 kHz)
Frequency range		10 Hz to 20 Hz
Maximum applicable circuit voltage		1000V AC (primary side)
External dimensions (W)×(H)×(D)		Approx.140mm×64mm×28mm
Weight		Approx.470g

*1) Varies depending on the input level and frequency. For detailed specifications, refer to the Users Manual that comes with the clamp-on power meter.

Appendix 1 Block Diagram

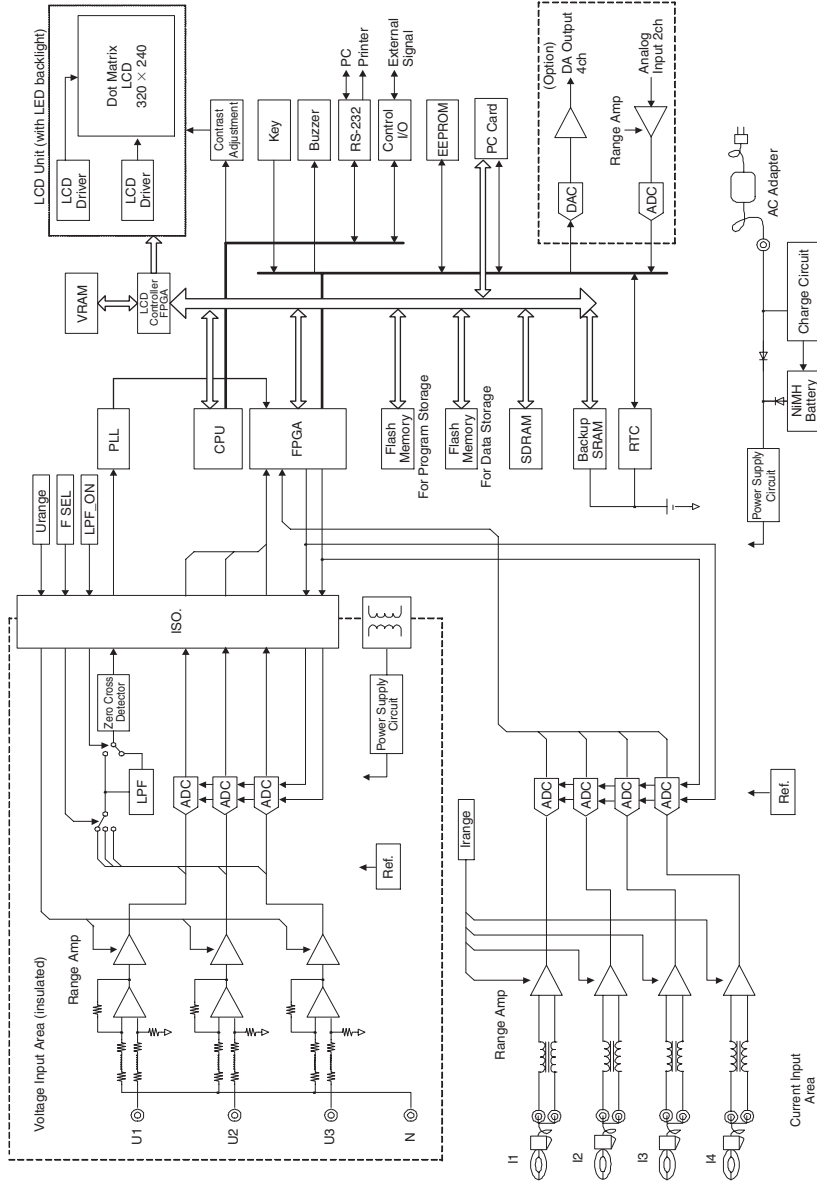

App
Appendix

Appendix 2 File/ Print Item Descriptions

Setting File Data Format

Manual storage measurement files, standard interval time measurement files, and voltage fluctuation measurement files are saved in CSV format (each piece of data is in text format, separated by a comma). This data can be used easily on a PC with various application software.

Manual Storage Measurement Data Format

```
MODEL,CW240,400
VERSION,1.00
ID,001
LOAD,1
WIRING,1P2W
VAR_METHOD,OFF
FREQUENCY,50Hz
SAMPLING,PLL
SOURCE,U1
INTERVAL,30min
U_RANGE,150V
A_RANGE,5A,20A,20A,20A
VT,1.00
CT,1.00,1.00,1.00,1.00
```

Setting Data

```
DATE,TIME,ETIME,U1_INST(V),... Header Characters
2004/02/05,00:00:00,000000:00:00,1.000E+02,...
2004/02/05,00:03:00,000000:00:00,1.000E+02,... Measurement Data
2004/02/05,00:10:00,000000:00:00,1.000E+02,...
```

App

Appendix

Appendix 2 File/Print Item Descriptions

Standard Interval Time Measurement Data Format

```

MODEL,CW240,200
VERSION,1.00
ID,001
LOAD,1
WIRING,1P2W
VAR_METHOD,OFF
FREQUENCY,50Hz
SAMPLING,PLL
SOURCE,U1
INTERVAL,30min
U_RANGE,150V
A_RANGE,5A,20A,20A,20A
VT,1.00
CT,1.00,1.00,1.00,1.00
    
```

Setting Data

```

2004/02/05,00:00:00,START ----- Measurement Start Date and Time
DATE,TIME,ETIME,U1_INST(V),... ----- Header Characters
2004/02/05,00:00:00,000000:00:00,1.000E+02,...
2004/02/05,00:30:00,000000:30:00,1.000E+02,... ----- Measurement Data
2004/02/05,01:00:00,000001:00:00,1.000E+02,...
2004/02/05,01:00:00,STOP ----- Measurement End Date and Time
    
```

Setting Data

Header Characters	Content
MODEL	Model, identification characters
VERSION	Version number
ID	ID number
LOAD	Load
WIRING	Wiring
VAR_METHOD	Reactive wattmeter method
FREQUENCY	Fixed clock
SAMPLING	Sampling method
SOURCE	Frequency measurement element
INTERVAL	Interval time
U_RANGE	Voltage range
A_RANGE	Current range
VT	VT ratio
CT	CT ratio

Header Characters

Normal Measurement Data (excluding 3P3W+1P3W)

Category	Header Characters	Content	Unit
Data output time	DATE	Data output date yyyy/mm/dd	
	TIME	Data output time hh:mm:ss	
	ETIME	Elapsed time hhhhhh:mm:ss	
Voltage	U1_INST(V)	Voltage 1 rms value	V
	U2_INST(V)	Voltage 2 rms value	
	U3_INST(V)	Voltage 3 rms value	
	Uave_INST(V)	Voltage rms value Average value between CHs	
Current	I1_INST(A)_1 to I1_INST(A)_4	Current 1 rms value Loads 1 to 4	A
	I2_INST(A)_1 to I2_INST(A)_2	Current 2 rms value Loads 1 and 2	
	I3_INST(A)_1 to I3_INST(A)_2	Current 3 rms value Loads 1 and 2	
	Iave_INST(A)_1 to Iave_INST(A)_2	Current rms value Average value between CHs Loads 1 and 2	
	I4_INST(A)_1	Current 4 rms value	
Electric Power	P_INST(W)_1 to P_INST(W)_4	Active power Loads 1 to 4	W
	Q_INST(Var)_1 to Q_INST(Var)_4	Reactive power Loads 1 to 4	Var
	S_INST(VA)_1 to S_INST(VA)_4	Apparent power Loads 1 to 4	VA
Power Factor	PF_INST_1 to PF_INST_4	Power factor Loads 1 to 4	
Phase Angle	PA_INST(deg)_1 to PA_INST(deg)_4	Phase angle Loads 1 to 4	deg
Frequency	F_INST(Hz)	Frequency	Hz
Each CH Value	P1_INST(W)_1 to P1_INST(W)_2	Active power 1 Loads 1 and 2	W
	P2_INST(W)_1 to P2_INST(W)_2	Active power 2 Loads 1 and 2	
	P3_INST(W)_1 to P3_INST(W)_2	Active power 3 Loads 1 and 2	
	Q1_INST(Var)_1 to Q1_INST(Var)_2	Reactive power 1 Loads 1 and 2	Var
	Q2_INST(Var)_1 to Q2_INST(Var)_2	Reactive power 2 Loads 1 and 2	
	Q3_INST(Var)_1 to Q3_INST(Var)_2	Reactive power 3 Loads 1 and 2	
	S1_INST(VA)_1 to S1_INST(VA)_2	Apparent power 1 Loads 1 and 2	VA
	S2_INST(VA)_1 to S2_INST(VA)_2	Apparent power 2 Loads 1 and 2	
	S3_INST(VA)_1 to S2_INST(VA)_2	Apparent power 3 Loads 1 and 2	
	PF1_INST_1 to PF1_INST_2	Power factor 1 Loads 1 and 2	
	PF2_INST_1 to PF2_INST_2	Power factor 2 Loads 1 and 2	
	PF3_INST_1 to PF3_INST_2	Power factor 3 Loads 1 and 2	
	PA1_INST(deg)_1 to PA1_INST(deg)_2	Phase angle 1 Loads 1 and 2	deg
	PA2_INST(deg)_1 to PA2_INST(deg)_2	Phase angle 2 Loads 1 and 2	
PA3_INST(deg)_1 to PA3_INST(deg)_2	Phase angle 3 Loads 1 and 2		
DC Voltage	DC1_INST(V)	DC voltage CH1	V
	DC2_INST(V)	DC voltage CH2	

- For the average value, INST becomes AVE.
- For the maximum value, INST becomes MAX.
- For the minimum value, INST becomes MIN.

App

Appendix

Appendix 2 File/Print Item Descriptions

Normal Measurement Data (excluding 3P3W+1P3W)

Category	Header Characters	Content	Unit
Electric Energy	Wh+_INTEG(Wh)_1 to Wh+_INTEG(Wh)_4	Active electric energy (consumed) Loads 1 to 4	Wh
	Wh-_INTEG(Wh)_1 to Wh-_INTEG(Wh)_4	Active electric energy (regenerative) Loads 1 to 4	
	Varh+_INTEG(Varh)_1 to Varh+_INTEG(Varh)_4	Reactive electric energy (lag) Loads 1 to 4	Varh
	Varh-_INTEG(Varh)_1 to Varh-_INTEG(Varh)_4	Reactive electric energy (lead) Loads 1 to 4	
Demand	Wh+_INTVL(Wh)_1 to Wh+_INTVL(Wh)_4	Active electric energy within interval time (consumed) Loads 1 to 4	Wh
	Wh-_INTVL(Wh)_1 to Wh-_INTVL(Wh)_4	Active electric energy within interval time (regenerative) Loads 1 to 4	
	Varh+_INTVL(Varh)_1 to Varh+_INTVL(Varh)_4	Reactive electric energy within interval time (lag) Loads 1 to 4	Varh
	Varh-_INTVL(Varh)_1 to Varh-_INTVL(Varh)_4	Reactive electric energy within interval time (lead) Loads 1 to 4	
	P_DEM(W)_1 to P_DEM(W)_4	Average active power within interval time (consumed) Loads 1 to 4	W
	Q_DEM(Var)_1 to Q_DEM(Var)_4	Average reactive power within interval time (lag) Loads 1 to 4	Var
	PF_DEM_1 to PF_DEM_4	Average power factor within interval time Loads 1 to 4	
	P_DEM_MAX(W)_1 to P_DEM_MAX(W)_4	Maximum demand value Active power Loads 1 to 4	W
	P_DEM_MAX_DATE_1 to P_DEM_MAX_DATE_4	Maximum demand date yyyy/mm/dd Loads 1 to 4	
	P_DEM_MAX_TIME_1 to P_DEM_MAX_TIME_4	Maximum demand time hh:mm:ss Loads 1 to 4	

Appendix 2 File/Print Item Descriptions

Harmonic Measurement Data (excluding 3P3W+1P3W)

Category	Header Characters	Content	Unit
Harmonic Level	U1(n)_INST(V)	nth order harmonic voltage 1 rms value	V
	U2(n)_INST(V)	nth order harmonic voltage 2 rms value	
	U3(n)_INST(V)	nth order harmonic voltage 3 rms value	
	I1(n)_INST(A)_1 to I1(n)_INST(A)_4	nth order harmonic current 1 rms value Loads 1 to 4	A
	I2(n)_INST(A)_1 to I2(n)_INST(A)_2	nth order harmonic current 2 rms value Loads 1 and 2	
	I3(n)_INST(A)_1 to I3(n)_INST(A)_2	nth order harmonic current 3 rms value Loads 1 and 2	
	I4(n)_INST(A)_1	nth order harmonic current 4 rms value	
P(n)_INST(W)_1 to P(n)_INST(W)_4	nth order harmonic electric power value Loads 1 to 4	W	
Harmonic Content	U1cont(n)_INST(%)	nth order harmonic voltage 1 content	%
	U2cont(n)_INST(%)	nth order harmonic voltage 2 content	
	U3cont(n)_INST(%)	nth order harmonic voltage 3 content	
	I1cont(n)_INST(%)_1 to I1cont(n)_INST(%)_4	nth order harmonic current 1 content Loads 1 to 4	
	I2cont(n)_INST(%)_1 to I2cont(n)_INST(%)_2	nth order harmonic current 2 content Loads 1 and 2	
	I3cont(n)_INST(%)_1 to I3cont(n)_INST(%)_2	nth order harmonic current 3 content Loads 1 and 2	
	I4cont(n)_INST(%)_1	nth order harmonic current 4 content	
Pcont(n)_INST(%)_1 to Pcont(n)_INST(%)_4	nth order harmonic electric power content Loads 1 to 4		
Harmonic Phase Angle	U1pa(n)_INST(deg)	nth order harmonic voltage 1 phase angle	deg
	U2pa(n)_INST(deg)	nth order harmonic voltage 2 phase angle	
	U3pa(n)_INST(deg)	nth order harmonic voltage 3 phase angle	
	I1pa(n)_INST(deg)_1 to I1pa(n)_INST(deg)_4	nth order harmonic current 1 phase angle Loads 1 to 4	
	I2pa(n)_INST(deg)_1 to I2pa(n)_INST(deg)_2	nth order harmonic current 2 phase angle Loads 1 and 2	
	I3pa(n)_INST(deg)_1 to I3pa(n)_INST(deg)_2	nth order harmonic current 3 phase angle Loads 1 and 2	
	I4pa(n)_INST(deg)_1	nth order harmonic current 4 phase angle	
Ppa(n)_INST(deg)_1 to Ppa(n)_INST(deg)_4	nth order harmonic electric power phase angle Loads 1 to 4		

- Any harmonic order of 01 to 50 is entered for n.
- For the average value, INST becomes AVE.
- For the maximum value, INST becomes MAX.
- For the minimum value, INST becomes MIN.

App

Appendix

Appendix 2 File/Print Item Descriptions

Harmonic Measurement Data (excluding 3P3W+1P3W)

Category	Header Characters	Content	Unit
Total Value	TOTAL_U1_INST(V)	Voltage 1 total value (1st to 50th order)	V
	TOTAL_U2_INST(V)	Voltage 2 total value (1st to 50th order)	
	TOTAL_U3_INST(V)	Voltage 3 total value (1st to 50th order)	
	TOTAL_I1_INST(A)_1 to TOTAL_I1_INST(A)_4	Current 1 total value (1st to 50th order) Loads 1 to 4	A
	TOTAL_I2_INST(A)_1 to TOTAL_I2_INST(A)_2	Current 2 total value (1st to 50th order) Loads 1 and 2	
	TOTAL_I3_INST(A)_1 to TOTAL_I3_INST(A)_2	Current 3 total value (1st to 50th order) Loads 1 and 2	
	TOTAL_I4_INST(A)_1	Current 4 total value (1st to 50th order)	
	TOTAL_P_INST(W)_1 to TOTAL_P_INST(W)_4	Electric power total value (1st to 50th order) Loads 1 to 4	W
THD-F (Selection)	THDF_U1_INST(%)	Voltage 1 total harmonic distortion factor	%
	THDF_U2_INST(%)	Voltage 2 total harmonic distortion factor	
	THDF_U3_INST(%)	Voltage 3 total harmonic distortion factor	
	THDF_I1_INST(%)_1 to THDF_I1_INST(%)_4	Current 1 total harmonic distortion factor Loads 1 to 4	
	THDF_I2_INST(%)_1 to THDF_I2_INST(%)_2	Current 2 total harmonic distortion factor Loads 1 and 2	
	THDF_I3_INST(%)_1 to THDF_I3_INST(%)_2	Current 3 total harmonic distortion factor Loads 1 and 2	
	THDF_I4_INST(%)_1	Current 4 total harmonic distortion factor	
THD-R (Selection)	THDR_U1_INST(%)	Voltage 1 total harmonic distortion factor	%
	THDR_U2_INST(%)	Voltage 2 total harmonic distortion factor	
	THDR_U3_INST(%)	Voltage 3 total harmonic distortion factor	
	THDR_I1_INST(%)_1 to THDR_I1_INST(%)_4	Current 1 total harmonic distortion factor Loads 1 to 4	
	THDR_I2_INST(%)_1 to THDR_I2_INST(%)_2	Current 2 total harmonic distortion factor Loads 1 and 2	
	THDR_I3_INST(%)_1 to THDR_I3_INST(%)_2	Current 3 total harmonic distortion factor Loads 1 and 2	
	THDR_I4_INST(%)_1	Current 4 total harmonic distortion factor	

- Any harmonic order of 01 to 50 is entered for n.
- For the average value, INST becomes AVE.
- For the maximum value, INST becomes MAX.
- For the minimum value, INST becomes MIN.

Appendix 2 File/Print Item Descriptions

Normal Measurement Data (3P3W+1P3W)

Category	Header Characters	Content	Unit	
Date and Time	DATE	Data output date		
	TIME	Data output time		
	ETIME	Elapsed time		
Voltage	3P3W	U1_INST(V)_3P	Voltage 1 rms value	V
		U2_INST(V)_3P	Voltage 2 rms value	
		U3_INST(V)_3P	Voltage 3 rms value	
	Uave_INST(V)_3P	Voltage rms value Average value between CHs		
	1P3W	U1_INST(V)_1P	Voltage 1 rms value	
		U2_INST(V)_1P	Voltage 2 rms value	
Uave_INST(V)_1P		Voltage rms value Average value between CHs		
Current	3P3W	I1_INST(A)_3P	Current 1 rms value	A
		I2_INST(A)_3P	Current 2 rms value	
		I3_INST(A)_3P	Current 3 rms value	
		Iave_INST(A)_3P	Current rms value Average value between CHs	
	1P3W	I1_INST(A)_1P	Current 1 rms value	
		Iave_INST(A)_1P	Current rms value Average value between CHs	
Electric Power	3P3W	P_INST(W)_3P	Active power	W
		Q_INST(Var)_3P	Reactive power	Var
		S_INST(VA)_3P	Apparent power	VA
		1P3W P_INST(W)_1P	Active power	W
		Q_INST(Var)_1P	Reactive power	Var
		S_INST(VA)_1P	Apparent power	VA
Power Factor	3P3W	PF_INST_3P	Power factor	
	1P3W	PF_INST_1P	Power factor	
Phase Angle	3P3W	PA_INST(deg)_3P	Phase angle	deg
	1P3W	PA_INST(deg)_1P	Phase angle	
Frequency		F_INST(Hz)	Frequency	Hz

- For the average value, INST becomes AVE.
- For the maximum value, INST becomes MAX.
- For the minimum value, INST becomes MIN.

Appendix 2 File/Print Item Descriptions

Normal Measurement Data (3P3W+1P3W)

Category		Header Characters	Content	Unit
Each CH Value	3P3W	P1_INST(W)_3P	Active power 1	W
		P3_INST(W)_3P	Active power 3	
		Q1_INST(Var)_3P	Reactive power 1	Var
		Q3_INST(Var)_3P	Reactive power 3	
		S1_INST(VA)_3P	Apparent power 1	VA
		S3_INST(VA)_3P	Apparent power 3	
		PF1_INST_3P	Power factor 1	
		PF3_INST_3P	Power factor 3	
		PA1_INST(deg)_3P	Phase angle 1	deg
	PA3_INST(deg)_3P	Phase angle 3		
	1P3W	P1_INST(W)_1P	Active power 1	W
		P2_INST(W)_1P	Active power 2	
		Q1_INST(Var)_1P	Reactive power 1	Var
		Q2_INST(Var)_1P	Reactive power 2	
		S1_INST(VA)_1P	Apparent power 1	VA
		S2_INST(VA)_1P	Apparent power 2	
		PF1_INST_1P	Power factor 1	
		PF2_INST_1P	Power factor 2	
PA1_INST(deg)_1P		Phase angle 1	deg	
PA2_INST(deg)_1P	Phase angle 2			
DC Voltage		DC1_INST(V)	DC voltage CH1	V
		DC2_INST(V)	DC voltage CH2	

- For the average value, INST becomes AVE.
- For the maximum value, INST becomes MAX.
- For the minimum value, INST becomes MIN.

Appendix 2 File/Print Item Descriptions

Normal Measurement Data (3P3W+1P3W)

Category	Header Characters	Content	Unit	
Electric Energy	3P3W	Wh+_INTEG(Wh)_3P	Active electric energy (consumed)	Wh
		Wh-_INTEG(Wh)_3P	Active electric energy (regenerative)	
		Varh+_INTEG(Varh)_3P	Reactive electric energy (lag)	Varh
		Varh-_INTEG(Varh)_3P	Reactive electric energy (lead)	
	1P3W	Wh+_INTEG(Wh)_1P	Active electric energy (consumed)	Wh
		Wh-_INTEG(Wh)_1P	Active electric energy (regenerative)	Wh
		Varh+_INTEG(Varh)_1P	Reactive electric energy (lag)	Varh
	Varh-_INTEG(Varh)_1P	Reactive electric energy (lead)	Varh	
Demand	3P3W	Wh+_INTVL(Wh)_3P	Active electric energy within interval time (consumed)	Wh
		Wh-_INTVL(Wh)_3P	Active electric energy within interval time (regenerative)	
		Varh+_INTVL(Varh)_3P	Reactive electric energy within interval time (lag)	Varh
		Varh-_INTVL(Varh)_3P	Reactive electric energy within interval time (lead)	
		P_DEM(W)_3P	Average active power within interval time (consumed)	W
		Q_DEM(Var)_3P	Average reactive power within interval time (lag)	Var
		PF_DEM_3P	Average power factor within interval time	
		P_DEM_MAX(W)_3P	Maximum demand value Active power	W
		P_DEM_MAX_DATE_3P	Maximum demand date	
		P_DEM_MAX_TIME_3P	Maximum demand time	
	1P3W	Wh+_INTVL(Wh)_1P	Active electric energy within interval time (consumed)	Wh
		Wh-_INTVL(Wh)_1P	Active electric energy within interval time (regenerative)	
		Varh+_INTVL(Varh)_1P	Reactive electric energy within interval time (lag)	Varh
		Varh-_INTVL(Varh)_1P	Reactive electric energy within interval time (lead)	
		P_DEM(W)_1P	Average active power within interval time (consumed)	W
		Q_DEM(Var)_1P	Average reactive power within interval time (lag)	Var
		PF_DEM_1P	Average power factor within interval time	Var
		P_DEM_MAX(W)_1P	Maximum demand value Active power	W
		P_DEM_MAX_DATE_1P	Maximum demand date	
		P_DEM_MAX_TIME_1P	Maximum demand time	

App

Appendix

Appendix 2 File/Print Item Descriptions

Harmonic Measurement Data (3P3W+1P3W)

Category	Header Characters	Content	Unit	
Harmonic Level	3P3W	U1(n)_INST(V)_3P	nth order harmonic voltage 1 rms value	
		U2(n)_INST(V)_3P	nth order harmonic voltage 2 rms value	
		U3(n)_INST(V)_3P	nth order harmonic voltage 3 rms value	
	3P3W	I1(n)_INST(A)_3P	nth order harmonic current 1 rms value	A
		I2(n)_INST(A)_3P	nth order harmonic current 2 rms value	
		I3(n)_INST(A)_3P	nth order harmonic current 3 rms value	
		P(n)_INST(W)_3P	nth order harmonic electric power value	
	1P3W	U1(n)_INST(V)_1P	nth order harmonic voltage 1 rms value	V
		U2(n)_INST(V)_1P	nth order harmonic voltage 2 rms value	V
		I1(n)_INST(A)_1P	nth order harmonic current 1 rms value	A
I2(n)_INST(A)_1P		nth order harmonic current 2 rms value		
P(n)_INST(W)_1P		nth order harmonic electric power value	W	
Harmonic Content	3P3W	U1cont(n)_INST(%)_3P	nth order harmonic voltage 1 content	
		U2cont(n)_INST(%)_3P	nth order harmonic voltage 2 content	
		U3cont(n)_INST(%)_3P	nth order harmonic voltage 3 content	
		I1cont(n)_INST(%)_3P	nth order harmonic current 1 content	
		I2cont(n)_INST(%)_3P	nth order harmonic current 2 content	
		I3cont(n)_INST(%)_3P	nth order harmonic current 3 content	
		Pcont(n)_INST(%)_3P	nth order harmonic electric power content	
	1P3W	U1cont(n)_INST(%)_1P	nth order harmonic voltage 1 content	%
		U2cont(n)_INST(%)_1P	nth order harmonic voltage 2 content	
		I1cont(n)_INST(%)_1P	nth order harmonic current 1 content	
Harmonic Phase Angle	3P3W	U1pa(n)_INST(deg)_3P	nth order harmonic voltage 1 phase angle	
		U2pa(n)_INST(deg)_3P	nth order harmonic voltage 2 phase angle	
		U3pa(n)_INST(deg)_3P	nth order harmonic voltage 3 phase angle	
		I1pa(n)_INST(deg)_3P	nth order harmonic current 1 phase angle	
		I2pa(n)_INST(deg)_3P	nth order harmonic current 2 phase angle	
		I3pa(n)_INST(deg)_3P	nth order harmonic current 3 phase angle	
		Ppa(n)_INST(deg)_3P	nth order harmonic electric power phase angle	
	1P3W	U1pa(n)_INST(deg)_1P	nth order harmonic voltage 1 phase angle	deg
		U2pa(n)_INST(deg)_1P	nth order harmonic voltage 2 phase angle	
		I1pa(n)_INST(deg)_1P	nth order harmonic current 1 phase angle	
1P3W	I2pa(n)_INST(deg)_1P	nth order harmonic current 2 phase angle	deg	
	Ppa(n)_INST(deg)_1P	nth order harmonic electric power phase angle		

- Harmonic order 01 to 50 is entered for n.
- For the average value, INST becomes AVE.
- For the maximum value, INST becomes MAX.
- For the minimum value, INST becomes MIN.

Appendix 2 File/Print Item Descriptions

Harmonic Measurement Data (3P3W+1P3W)

Category	Header Characters	Content	Unit
Total Value	3P3W	TOTAL_U1_INST(V)_3P	Voltage 1 total value (1st to 50th order)
		TOTAL_U2_INST(V)_3P	Voltage 2 total value (1st to 50th order)
		TOTAL_U3_INST(V)_3P	Voltage 3 total value (1st to 50th order)
		TOTAL_I1_INST(A)_3P	Current 1 total value (1st to 50th order)
		TOTAL_I2_INST(A)_3P	Current 2 total value (1st to 50th order)
		TOTAL_I3_INST(A)_3P	Current 3 total value (1st to 50th order)
	TOTAL_P_INST(W)_3P	Electric power total value (1st to 50th order)	
	1P3W	TOTAL_U1_INST(V)_1P	Voltage 1 total value (1st to 50th order)
		TOTAL_U2_INST(V)_1P	Voltage 2 total value (1st to 50th order)
		TOTAL_I1_INST(A)_1P	Current 1 total value (1st to 50th order)
TOTAL_I2_INST(A)_1P		Current 2 total value (1st to 50th order)	
TOTAL_P_INST(W)_1P		Electric power total value (1st to 50th order)	
THD-F (Selection)	3P3W	THDF_U1_INST(%)_3P	Voltage 1 total harmonic distortion factor
		THDF_U2_INST(%)_3P	Voltage 2 total harmonic distortion factor
		THDF_U3_INST(%)_3P	Voltage 3 total harmonic distortion factor
		THDF_I1_INST(%)_3P	Current 1 total harmonic distortion factor
		THDF_I2_INST(%)_3P	Current 2 total harmonic distortion factor
		THDF_I3_INST(%)_3P	Current 3 total harmonic distortion factor
	1P3W	THDF_U1_INST(%)_1P	Voltage 1 total harmonic distortion factor
		THDF_U2_INST(%)_1P	Voltage 2 total harmonic distortion factor
		THDF_I1_INST(%)_1P	Current 1 total harmonic distortion factor
		THDF_I2_INST(%)_1P	Current 2 total harmonic distortion factor
THD-R (Selection)	3P3W	THDR_U1_INST(%)_3P	Voltage 1 total harmonic distortion factor
		THDR_U2_INST(%)_3P	Voltage 2 total harmonic distortion factor
		THDR_U3_INST(%)_3P	Voltage 3 total harmonic distortion factor
		THDR_I1_INST(%)_3P	Current 1 total harmonic distortion factor
		THDR_I2_INST(%)_3P	Current 2 total harmonic distortion factor
		THDR_I3_INST(%)_3P	Current 3 total harmonic distortion factor
	1P3W	THDR_U1_INST(%)_1P	Voltage 1 total harmonic distortion factor
		THDR_U2_INST(%)_1P	Voltage 2 total harmonic distortion factor
		THDR_I1_INST(%)_1P	Current 1 total harmonic distortion factor
		THDR_I2_INST(%)_1P	Current 2 total harmonic distortion factor

- Harmonic order 01 to 50 is entered for n.
- For the average value, INST becomes AVE.
- For the maximum value, INST becomes MAX.
- For the minimum value, INST becomes MIN.

App

Appendix

Appendix 2 File/Print Item Descriptions

Voltage Fluctuation Measurement Data Format

MODEL,CW240,T006
VERSION,1.00
ID,001
WIRING,1P2W
FREQUENCY,50Hz
SAMPLING,PLL
SOURCE,U1
U_RANGE,150V
VT,1.00
STD_VOLT,100V
HYSTERESIS,1
SWELL,110
DIP,90
INTERRUPTION,10



Setting Data

NO,DATE,TIME,,TYPE,CH,IN/OUT,U_INST(V),PERIOD_TIME, ——— Header Characters
1,2004/02/05,00:00:00,000,SWELL,U1,IN,9.000E+01,0000:00:00,000
2,2004/02/05,00:00:01,000,SWELL,U1,OUT,1.000E+02,0000:00:01,000 — Detection Data

Setting Data

Header Characters	Content
MODEL	Model, identification characters
VERSION	Version number
ID	ID number
WIRING	Wiring
FREQUENCY	Fixed clock
SAMPLING	Sampling method
SOURCE	Frequency measurement element
U_RANGE	Voltage range
VT	VT ratio
STD_VOLT	Standard voltage
HYSTERESISE	Detection hysteresis
SWELL	Detection voltage swell
DIP	Detection voltage dip
INTERRUPTION	Detection voltage interruption

Detection Data

Header Characters	Content	
NO	Number	
DATE	Detection date	yyyy/mm/dd
TIME	Detection time	hh:mm:ss
		nnn msec
TYPE	Detection type	SWELL : swell DIP : dip INTER : interruption
CH	Voltage CH	U1,U2,U3 U1_3P,U2_3P,U3_3P U1_1P,U2_1P
IN/OUT	Detection start/end	IN : start OUT: end
U_INST(V)	Detection voltage rms value (V)	
PERIOD_TIME	Interval	hhhh:mm:ss
		nnn msec

Appendix 2 File/Print Item Descriptions

Printer Output Contents

Normal Measurement Data (excluding 3P3W+1P3W)

Category	Header Characters	Content	Unit
Date and Time	Output time	Data output date yyyy/mm/dd hh:mm:ss	
	Demand start time	Demand start time yyyy/mm/dd hh:mm:ss	
	Elapsed time	Elapsed time hhhhhh:mm:ss	
	***** INST(LOAD1) ***** to ***** INST(LOAD4) *****	Instantaneous value Loads 1 to 4	
	***** AVE(LOAD1) ***** to ***** AVE(LOAD4) *****	Average value Loads 1 to 4	
	***** MAX(LOAD1) ***** to ***** MAX(LOAD4) *****	Maximum value Loads 1 to 4	
	***** MIN(LOAD1) ***** to ***** MIN(LOAD4) *****	Minimum value Loads 1 to 4	
Voltage	U1	Voltage 1 rms value	V, kV, MV
	U2	Voltage 2 rms value	
	U3	Voltage 3 rms value	
	Uave	Voltage rms value Average value between CHs	
Current	I1	Current 1 rms value	mA, A, kA, MA
	I2	Current 2 rms value	
	I3	Current 3 rms value	
	Iave	Current rms value Average value between CHs	
Electric Power	P	Current 4 rms value	mW, W, kW, MW, GW, TW
	Q	Active power	MVar, Var, kVar, MVar, GVar, TVar
	S	Reactive power	mVA, VA, kVA, MVA, GVA, TVA
Power Factor	PF	Apparent power	
Phase Angle	PA	Power factor	deg
Frequency	F	Phase angle	Hz
Each CH Value	P1	Active power 1	mW, W, kW,MW, GW, TW
	P2	Active power 2	
	P3	Active power 3	
	Q1	Reactive power 1	mVar, Var, kVar, MVar, GVar, TVar
	Q2	Reactive power 2	
	Q3	Reactive power 3	
	S1	Apparent power 1	mVA, VA, kVA, MVA, GVA, TVA
	S2	Apparent power 2	
	S3	Apparent power 3	
	PF1	Power factor 1	
	PF2	Power factor 2	
	PF3	Power factor 3	
	PA1	Phase angle 1	deg
	PA2	Phase angle 2	
	PA3	Phase angle 3	

Appendix 2 File/Print Item Descriptions

Normal Measurement Data (excluding 3P3W+1P3W)

Category	Header Characters	Content	Unit
DC Voltage	DC1	DC voltage CH1	mV, V
	DC2	DC voltage CH2	
	**** INTEGRATE(LOAD1) ***** to ***** INTEGRATE(LOAD4) *****	Electric energy Loads 1 to 4	
Electric Energy	Wh+	Active electric energy (consumed)	mWh, Wh, kWh, MWh, GWh
	Wh-	Active electric energy (regenerative)	
	Varh+	Reactive electric energy (lag)	mVarh, Varh, kVarh, MVarh, GVarh
	Varh-	Electric energy (lead)	
	***** INTERVAL(LOAD1) ***** to ***** INTERVAL(LOAD4) *****	Active electric energy within interval time Loads 1 to 4	
Demand	Wh+	Active electric energy within interval time (consumed)	mVarh, Varh, kVarh, MVarh, GVarh
	Wh-	Active electric energy within interval time (regenerative)	
	Varh+	Reactive electric energy within interval time (lag)	mVarh, Varh, kVarh, MVarh, GVarh
	Varh-	Reactive electric energy within interval time (lead)	
	***** DEMMAND(LOAD1) ***** to ***** DEMMAND(LOAD4) *****	Demand Loads 1 to 4	
Demand	P	Average active power within interval time (consumed)	mW, W, kW, MW, GW, TW
	Q	Average reactive power within interval time (lag)	MVar, Var, kVar, MVar, GVar, TVar
	PF	Average power factor within interval time	
	Pmax	Maximum demand value Active power	mW, W, kW, MW, GW, TW
	DATE	Maximum demand date yyyy/mm/dd	
	TIME	Maximum demand time hh:mm:ss	

Appendix 2 File/Print Item Descriptions

Harmonic Measurement Data (excluding 3P3W+1P3W)

Category	Header Characters	Content	Unit
	***** INST(LOAD1) ***** to ***** INST(LOAD4) *****	Instantaneous value Loads 1 to 4	
	***** AVE(LOAD1) ***** to ***** AVE(LOAD4) *****	Average value Loads 1 to 4	
	***** MAX(LOAD1) ***** to ***** MAX(LOAD4) *****	Maximum value Loads 1 to 4	
	***** MIN(LOAD1) ***** to ***** MIN(LOAD4) *****	Minimum value Loads 1 to 4	
Voltage	U1	Voltage 1	
	U2	Voltage 2	
	U3	Voltage 3	
Current	I1	Current 1	
	I2	Current 2	
	I3	Current 3	
	I4	Current 4	
Electric Power	P	Electric power	
Order	ORDER	Harmonic order	
Level	LEVEL	Harmonic level	V, kV, MV
			mA, A, kA, MA
			mW, W, kW, MW, GW, TW
Content	CONT.	Harmonic content	%
Phase Angle	PA	Harmonic phase angle	deg
Total Value	TOTAL	Total value (1st to 50th order)	V, kV, MV
			mA, A, kA, MA
			mW, W, kW, MW, GW, TW
THD-F (Selection)	THDF	Total harmonic distortion factor (THD-F)	%
THD-R (Selection)	THDR	Total harmonic distortion factor (THD-R)	%

Appendix 2 File/Print Item Descriptions

Normal Measurement Data (3P3W+1P3W)

Category	Header Characters	Content	Unit
Date and Time	Output time	Data output date yyyy/mm/dd hh:mm:ss	
	Demand start time	Demand start time yyyy/mm/dd hh:mm:ss	
	Elapsed time	Elapsed time hhhhhh:mm:ss	
	***** INST(3P3W) *****	Instantaneous value 3P3W	
	***** AVE(3P3W) *****	Average value 3P3W	
	***** MAX(3P3W) *****	Maximum value 3P3W	
	***** MIN(3P3W) *****	Minimum value 3P3W	
	***** INST(1P3W) *****	Instantaneous value 1P3W	
	***** AVE(1P3W) *****	Average value 1P3W	
	***** MAX(1P3W) *****	Maximum value 1P3W	
	***** MIN(1P3W) *****	Minimum value 1P3W	
Voltage	U1	Voltage 1 rms value	V, kV, MV
	U2	Voltage 2 rms value	
	U3	Voltage 3 rms value	
	Uave	Voltage rms value Average value between CHs	
Current	I1	Current 1 rms value	mA, A, kA, MA
	I2	Current 2 rms value	
	I3	Current 3 rms value	
	Iave	Current rms value Average value between CHs	
Electric Power	P	Active power	mW, W, kW, MW, GW, TW
	Q	Reactive power	MVar, Var, kVar, MVar, GVar, TVar
	S	Apparent power	mVA, VA, kVA, MVA, GVA, TVA
Power Factor	PF	Power factor	
Phase Angle	PA	Phase angle	deg
Frequency	F	Frequency	Hz
Each CH Value	P1	Active power 1	mW, W, kW, MW, GW, TW
	P2	Active power 2	
	P3	Active power 3	
	Q1	Reactive power 1	mVar, Var, kVar, MVar, GVar, TVar
	Q2	Reactive power 2	
	Q3	Reactive power 3	
	S1	Apparent power 1	mVA, VA, kVA, MVA, GVA, TVA
	S2	Apparent power 2	
	S3	Apparent power 3	
	PF1	Power factor 1	
	PF2	Power factor 2	
	PF3	Power factor 3	
	PA1	Phase angle 1	deg
	PA2	Phase angle 2	
	PA3	Phase angle 3	

Appendix 2 File/Print Item Descriptions

Normal Measurement Data (3P3W+1P3W)

Category	Header Characters	Content	Unit
DC Voltage	DC1	DC voltage CH1	mV, V
	DC2	DC voltage CH2	
	***** INTEGRATE(3P3W) *****	Electric energy 3P3W	
	***** INTEGRATE(1P3W) *****	Electric energy 1P3W	
Electric Energy	Wh+	Active electric energy (consumed)	mWh, Wh, kWh, MWh, GWh
	Wh-	Active electric energy (regenerative)	
	Varh+	Reactive electric energy (lag)	mVarh, Varh, kVarh, MVarh, GVarh
	Varh-	Electric energy (lead)	
	***** INTERVAL(3P3W) *****	Active electric energy within interval time	
	***** INTERVAL(1P3W) *****	Demand 3P3W,1P3W	
Demand	Wh+	Active electric energy within interval time(consumed)	mWh, Wh, kWh, MWh, GWh
	Wh-	Active electric energy within interval time (regenerative)	
	Varh+	Reactive electric energy within interval time (lag)	mVarh, Varh, kVarh, MVarh, GVarh
	Varh-	Reactive electric energy within interval time (lead)	
	***** DEMMAND(3P3W) *****	Demand 3P3W	
	***** DEMMAND(1P3W) *****	Demand 1P3W	
Demand	P	Average active power within interval time (consumed)	mW, W, kW, MW, GW, TW
	Q	Average reactive power within interval time (lag)	MVar, Var, kVar, MVar, GVar, TVar
	PF	Average power factor within interval time	
	Pmax	Maximum demand value Active power	mW, W, kW, MW, GW, TW
	DATE	Maximum demand date yyyy/mm/dd	
	TIME	Maximum demand time hh:mm:ss	

Appendix 2 File/Print Item Descriptions

Harmonic Measurement Data (3P3W+1P3W)

Category	Header Characters	Content	Unit
	***** INST(3P3W) *****	Instantaneous value 3P3W	
	***** AVE(3P3W) *****	Average value 3P3W	
	***** MAX(3P3W) *****	Maximum value 3P3W	
	***** MIN(3P3W) *****	Minimum value 3P3W	
	***** INST(1P3W) *****	Instantaneous value 1P3W	
	***** AVE(1P3W) *****	Average value 1P3W	
	***** MAX(1P3W) *****	Maximum value 1P3W	
Voltage	U1	Voltage 1	
	U2	Voltage 2	
	U3	Voltage 3	
Current	I1	Current 1	
	I2	Current 2	
	I3	Current 3	
Electric Power	P	Electric power	
Order	ORDER	Harmonic order	
Level	LEVEL	Harmonic level	V, kV, MV
			mA, A, kA, MA
			mW, W, kW, MW, GW, TW
Content	CONT.	Harmonic content	%
Phase Angle	PA	Harmonic phase angle	deg
Total Value	TOTAL	Total value (1st to 50th order)	V, kV, MV
			mA, A, kA, MA
			mW, W, kW, MW, GW, TW
THD-F (Selection)	THDF	Total harmonic distortion factor (THD-F)	%
THD-R (Selection)	THDR	Total harmonic distortion factor (THD-R)	%

App

Appendix

Appendix 2 File/Print Item Descriptions

Voltage Fluctuation Measurement Data

Header Characters	Content	
NO	Number	
DATE	Detection date	yyyy/mm/dd
TIME	Detection time	hh:mm:ss
		.nnn msec
TYPE	Detection type	SWELL: swell DIP : dip INTER : interruption
CH	Voltage CH	U1,U2,U3 U1_3P,U2_3P,U3_3P U1_1P,U2_1P
IN/OUT	Detection start/end	IN : start OUT : end
U_INST(V)	Detection voltage rms value	Units: V,kV,MV
PERIOD_TIME	Interval	hhhh:mm:ss
		.nnn msec

Appendix 3 Polarity (Active Power, Reactive Power, Power Factor, Phase Angle)

With the CW240, the polarity of the active power, the reactive power, the power factor, and the phase angle are expressed through the voltage and current phase as shown in the following diagram.

Phase Difference	180	Lag 90	0	Lead 90	180
Active Power	-	+	+	-	-
Reactive Power	+	+	-	-	-
Power Factor	-	+	-	+	+
Phase Angle	-	+	-	+	+

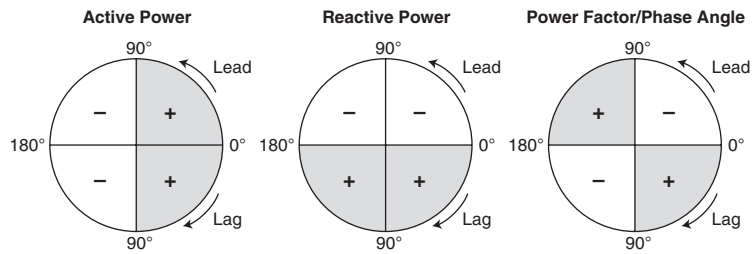

When active power is "+" : Energy is being supplied from the power supply side to the load side. This is the normal status.

When active power is "-" : Indicates that energy is being supplied from the load side to the power supply side, and regenerative power is being generated.

When reactive power is "+" : Indicates that the current phase is lagging behind the voltage phase. If the reactive power is large, it is necessary to connect a phase-advanced capacitor, etc., and improve the power factor.

When reactive power is "-" : Indicates that the current phase is leading the voltage phase.

App

Appendix

Appendix 4 Polarity (Harmonic Measurement)

● Voltage Phase Angle, Current Phase Angle

With the CW240, measurement can be done selecting either the U1 fundamental wave phase or the measurement element fundamental wave phase as the standard.

In either case, the polarity is as follows.

- Lead : + (0 to 180°)
- Lag : - (0 to -180°)

● Harmonic Power

Harmonic power measures the electric power of each order. The following is determined according to polarity.

- When the polarity of harmonic power is +: Harmonics are **flowing from the power supply to the load.**
- When the polarity of harmonic power is -: Harmonics are **flowing from the load to the power supply.**

● Harmonic Power Phase Angle

The harmonic power phase angle calculates the phase angle from the power factor of each order.

There is a difference between using the reactive power method and not using it, as indicated below.

When not using the reactive power method

The harmonic power phase angle formula is

$$\theta_{pn} = \cos^{-1} \left(\frac{P_n}{S_n} \right)$$

and P_n (active power) has polarity, but S_n (apparent power) does not have polarity. As a result, φ_{pn} becomes 0 to 180°, and the inflow/outflow of harmonics can be determined as indicated below, but lead/lag cannot be determined.

- When 0 to 90° : Harmonics are **flowing from the power supply to the load.**
- When 90 to 180° : Harmonics are **flowing from the load to the power supply.**

App

Appendix

Appendix 4 Polarity (Harmonic Measurement)

When using the reactive power method
The harmonic power phase angle equations is

$$\theta_{pn} = \tan^{-1} \left(\frac{Q_n}{P_n} \right)$$

and P_n (active power) and Q_n (reactive power) both have polarity. As a result, ϕ_{pn} becomes 0 to $\pm 180^\circ$, and the inflow/outflow and lead/lag of harmonics can be determined, as indicated below.

- When -90 to 90° : Harmonics are **flowing from the power supply to the load.**
- When -90 to -180° or 90 to 180° : Harmonics are **flowing from the load to the power supply.**
- When 0 to 180° : Lead phase
- When 0 to -180° : Lag phase

Appendix 5 Reactive Power Method

Reactive Power Method

With the CW240, it is possible to select a reactive power calculation method that either uses the reactive power method (reactive power method 1) or does not use it (reactive power method 2).

● **When not using the reactive power method (reactive power 2)**

The calculation obtains the reactive power through the following formula from apparent power VA (the product of the rms values of the voltage and current) and active power P. Even if differing frequency elements are included in the voltage and current, it is calculated as the rms value.

Even when not using the reactive power method, calculation through the reactive power method is performed separately, and the polarity (code) obtained with the reactive power method is used for polarity (SQ).

When the current lags behind the voltage : No polarity display

When the current leads the voltage : Polarity display is – (minus).

$$Q = SQ \sqrt{(VA)^2 - P^2}$$

Q = Reactive power

SQ = Polarity obtained through
the reactive power method

VA = Apparent power

P = Active power

In this case, the power factor is also obtained from the apparent power and the active power, and this power factor is called the rms value power factor. It is an operation that is used commonly. The polarity obtained with the reactive power method is used to be able to determine lead/lag of the power factor polarity as well.

Appendix 5 Reactive Power Method

● When using the reactive power method (reactive power 1)

The calculation shifts the current phase 90°, in the same manner as a common wattmeter, and measures the reactive power directly. With this operation, imbalance in the object of measurement, and the influence of harmonic elements, can be removed, and the result is a measurement value for only frequency elements that are the same as the voltage and current.

$$Q = \frac{1}{T} \int_0^T v(t) \times i\left(t + \frac{T}{4}\right) dt$$

Q = Reactive power
v(t), i(t) = Input signal
T = 1 cycle of input signal

In this case, the power factor is obtained from the active power and the reactive power, and this power factor is called the power ratio power factor.

If the voltage and current are both sine waves (the state excluding harmonic elements) and are balanced, the value obtained from the above two types of calculation will be the same result. If either voltage or current are unbalanced, or harmonic elements are included, the result will differ, so it is necessary to select the measurement method according to the state of the object of measurement and the content of analysis.

Also, when comparing with other measuring devices, etc., make the selection after confirming the measurement principles of that measuring device.

Appendix 6 Sampling Method

The sampling method can be set on the basic setting 2/2 screen.
Refer to Section 6.3.2, Setting up the Sampling Method.

The PLL synchronization method and the fixed clock can be selected.
It is ordinarily set to PLL synchronization.

● PLL Synchronization

The operation is done by performing PLL synchronization with the zero cross signal of frequency measurement input.

● Fixed Clock

Sampling of 128 times the fixed clock is performed.
50 Hz or 60 Hz can be selected for the fixed clock.
Select 50 Hz or 60 Hz according to the measurement line frequency.

● PLL Unlock

"PLL unlock" indicates the state in which the frequency measurement input is at or below the specified value when PLL synchronization has been set.

In this case, the mode switches to the fixed clock method, the measurement is performed, and the  mark is displayed on the screen.

Sampling is done at the frequency set with the fixed clock.
Even in the case of PLL synchronization, confirm that the frequency setting matches the measurement line.

Appendix 7 Terminology

Symbol	Unit	Item	Content
U1, U2, U3	V	Voltage Input	
Uave	V	Voltage Average Value	
I1, I2, I3, I4	A	Current Input	
Iave	A	Current Average Value	
P	W	Active Power	Active power
Q	Var	Reactive Power	Reactive power
S	VA	Apparent Power	Apparent power
PF	–	Power Factor	Power factor
PA	° (deg)	Phase Angle	Phase angle
+ Wh	Wh	(Active) Energy	Active energy
– Wh	Wh	Regenerative Energy	Regenerative energy
+ Varh	Varh	Lag Reactive Power	Ractive energy
– Varh	Varh	Lead Reactive Power	Ractive energy
THD	%	Total Harmonic Distortion Ratio	Total harmonic distortion
f	Hz	Frequency	Frequency
VT	–	Voltage Transformer	Voltage Transformer
CT	–	Current Transformer	Current Transformer
PLL		Sampling Method	Phase locked loop
		PLL Synchronization	

YOKOGAWA 
Yokogawa M&C Corporation

YOKOGAWA M&C CORPORATION

International Sales Dept.

2-9-32 Nakacho, Musashino-shi, Tokyo, 180-8750 Japan
Phone: 81-422-52-5716 Facsimile: 81-422-55-8954

YOKOGAWA CORPORATION OF AMERICA (U.S.A.)
Phone: 1-770-253-7000 Facsimile: 1-770-251-2088

YOKOGAWA EUROPE B. V. (THE NETHERLANDS)
Phone: 31-334-64-1611 Facsimile: 31-334-64-1610

YOKOGAWA ENGINEERING ASIA PTE. LTD. (SINGAPORE)
Phone: 65-6241-9933 Facsimile: 65-6241-2606

YOKOGAWA AMERICA DO SUL S. A. (BRAZIL)
Phone: 55-11-5681-2400 Facsimile: 55-11-5681-1274

YOKOGAWA MEASURING INSTRUMENTS KOREA CORPORATION (KOREA)
Phone: 82-2-551-0660 to -0664 Facsimile: 82-2-551-0665

YOKOGAWA AUSTRALIA PTY. LTD. (AUSTRALIA)
Phone: 61-2-9805-0699 Facsimile: 61-2-9888-1844

YOKOGAWA INDIA LTD. (INDIA)
Phone: 91-80-2227-1513 Facsimile: 91-80-2227-4270

YOKOGAWA SHANGHAI TRADING CO., LTD. (CHINA)
Phone: 86-21-6880-8107 Facsimile: 86-21-6880-4987

YOKOGAWA MIDDLE EAST E. C. (BAHRAIN)
Phone: 973-358100 Facsimile: 973-336100

LTD. YOKOGAWA ELECTRIC (RUSSIAN FEDERATION)
Phone: 7-095-737-7868 Facsimile: 7-095-737-7869

KIM3E-2004.7