

# M4000 Insulation Analyzer User Guide

---



Doble Engineering Company  
85 Walnut Street  
Watertown, Massachusetts 02472-4037  
(USA)

Copyright © 2000

By Doble Engineering Company

All Rights Reserved.

This Manual is the sole property of the Doble Engineering Company (Doble) and is provided for the exclusive use of Doble Clients under contractual agreement for Doble Test Equipment and Services.

In no event does the Doble Engineering Company assume the liability for any technical or editorial errors of commission, or omission; nor is Doble liable for direct, indirect, incidental, or consequential damages arising out of the use or inability to use this Manual.

Government Restricted Rights Legend: Use, duplication, or disclosure by the U.S. Government is subject to restrictions as set forth in subparagraphs (c)(1) and (c)(2) of the Commercial Computer Software - Restricted Rights Clause at FAR 52.227-19.

This manual is protected by copyright, all rights reserved, and no part hereof may be photocopied or reproduced in any form without prior written consent of the Doble Engineering Company.

Copyright © 2000

By Doble Engineering Company

All Rights Reserved.

# Preface

## Structure of this Manual

This manual consists of 4 chapters and 4 appendices.

Chapter 1	“Introduction” introduces the functions and architecture of the M4000 Insulation Analyzer, as well as important safety considerations for its use.
Chapter 2	“M4000 Software” provides an overview of M4000 software and its installation.
Chapter 3	“Running M4000 Tests” describes procedures for executing specimen tests.
Chapter 4	“M4100 Instrument Troubleshooting” provides initial steps in troubleshooting problems and isolating a problem to either the M4100 or M4200c.
Appendix A	“M4000 Components Lists” describes accessories included with the M4000 Insulation Analyzer.
Appendix B	“Warranty” provides Doble warranty provisions applicable to the M4000.
Appendix C	“Error Messages” lists error message numbers and descriptions.
Appendix D	“Part Numbers” lists the M4000 Insulation Analyzer part numbers.

---

## Conventions Used in this Manual

The following terms and typographical conventions are used in the manual:

<b>Convention</b>	<b>Description</b>
Windows	Refers to the Microsoft Windows operating system, Version 98 or later.
Click	Quickly press and release the left mouse button.
Double-click	Quickly press and release the left mouse button twice without moving the mouse.
Select	Position the cursor on the desired option and click the left mouse button once. Or, highlight the desired option using the arrow keys and press ENTER. Or, press ALT and the underlined letter.
Press	Type a single keyboard key. For example, press ENTER.
FN+(appropriate key)	Press and hold the FN key, and press (appropriate key).
<b>Bold Courier Text</b>	Indicates characters to be typed.

## 1. Introduction

Measurement Principles .....	1-1
Safety .....	1-1
M4000 Components .....	1-2
M4100 Instrument .....	1-2
M4200c Controller .....	1-5
Third-Party Controller .....	1-7
M4000 Software .....	1-7
Optional M4150 And M4151 Field Calibration References .....	1-7
Doble Standard Turns Ratio Capacitor .....	1-8
External Reference .....	1-8
M4300 Transport .....	1-8
Doble Test Assistant (DTA) Software .....	1-9
M4110 Leakage Reactance Interface .....	1-9
Operating with the M4300 Transport .....	1-10
Storage and Moving Mode .....	1-10
Testing Mode .....	1-13
When Finished Testing .....	1-15
M4000 PC Cable .....	1-16
Transport, Storage and Shipping .....	1-17
Transporting and Storing the M4000 .....	1-17
Shipping Instructions .....	1-18
Safety Considerations .....	1-19
Definitions .....	1-19
Safety Practices – General Rules .....	1-20
Clearances .....	1-20
Grounding .....	1-21
Personnel Safety .....	1-21
M4000 Connections .....	1-22
M4000 Operation .....	1-23
M4000 Safety Features .....	1-23
Safety Precautions .....	1-25
Safety Precautions for Various Types of Apparatus .....	1-26
Safety Summary .....	1-28

---

## 2. M4000 Software

Upgrading or Installing M4000 Software .....	2-1
Software Installation .....	2-1
M4000 Software .....	2-1
Doble Test Assistant (DTA) Software (Optional) .....	2-5
Optimization .....	2-5
COM port Setting .....	2-5
Mouse Settings .....	2-5
Time/Date Format .....	2-6
Introduction to M4000 Software .....	2-6
What's New .....	2-6
The M4000 Program .....	2-7
Icons .....	2-7
Menu Bar .....	2-8
Clipboard Test Mode .....	2-9
Menu Items .....	2-11
Mode Menu .....	2-11
Test Menu .....	2-11
Diagnostics .....	2-12
View Menu .....	2-12
Tools Menu .....	2-12
Temperature Correction .....	2-12
Configuration .....	2-13
System Configuration .....	2-13
Clipboard Configuration .....	2-14
DTA Field Configuration .....	2-16
Instrument Configuration .....	2-18
Advanced Configuration .....	2-19
Using Help .....	2-21
Contents .....	2-21
About M4000 For Windows .....	2-22
Printer Setup .....	2-22
Printing .....	2-22

## 3. Running M4000 Tests

Entering Clipboard Information .....	3-1
Nameplate Information .....	3-1
Administrative Information.....	3-2
Test Conditions .....	3-3
Test Results Information .....	3-4
Running Single and Multiple Clipboard Tests .....	3-6
Raising Test Voltage .....	3-7
Test Results .....	3-8
Clearing Test Results .....	3-10
Saving Test Results .....	3-11
Graphing Test Results .....	3-11
External Reference/Source Test (Optional Software) .....	3-12
Running A UST Test.....	3-12
Running a GST-Guard Test.....	3-14
Leakage Reactance Test (Optional Software) .....	3-16
DTA Mode.....	3-17
DTA Tests.....	3-17
DTA Data Manager .....	3-18
Preparing for a DTA Test.....	3-19
Starting a DTA Test.....	3-19
DTA Icons and Function Keys .....	3-24
Using A Resonator.....	3-25
Operating Procedure of Type C Resonating Inductor .....	3-26
General Description of Type C-1 Coupler - RIV Test Procedure .....	3-28

#### **4. M4100 Instrument Troubleshooting**

Assigning A Trouble To The M4100 Instrument (Or The M4200c Controller).....	4-1
Quick Checks .....	4-1
Troubleshooting Resources .....	4-2
Isolating Trouble .....	4-3
Avoiding Problems.....	4-4
Detailed Troubleshooting Of The M4100 Instrument.....	4-5
Overview of M4100.....	4-7
Overview of Individual Replaceable Components.....	4-9
Troubleshooting from Symptoms.....	4-12
Troubleshooting from Error Messages .....	4-16

---

Troubleshooting from Diagnostics .....	4-21
Running Diagnostics.....	4-21
System Status.....	4-23
Calibration Verification.....	4-26
Field Recalibration .....	4-31
Subsystem Diagnostics.....	4-34
M4100 Component List.....	4-38
Thermal Profile.....	4-39
Communications Loopback Test.....	4-40
Running Other Tests .....	4-42
Checking the High Voltage Test Cable.....	4-42
Checking the Low Voltage Test Leads.....	4-42
Checking M4100 Guard-to-Ground Insulation .....	4-43
Checking Instrument Accuracy in the Field.....	4-43
Voltage Verification .....	4-44
Accessing M4100 Components .....	4-46
Removing the Front and Top Covers .....	4-46
Removing the Card Cage Cover.....	4-48
M4100 Internal Checks.....	4-50
Fan Operation .....	4-50
Low-Voltage Power Checkout .....	4-51
Guard-to-Ground Shorting Problems .....	4-51
LVPS Fuses .....	4-52
W8/W9/W11 Cable Checkout.....	4-53
Orange Cable Checkout.....	4-54
Transformer Checks .....	4-54
W46 Cable Checkout.....	4-55



Replacing M4100 Components .....	4-56
Returning Replaced Components .....	4-57
Removing and Replacing the Front Panel Assembly .....	4-58
Replacing the Guard Front Panel Board .....	4-61
Replacing the Amplifier Assembly .....	4-63
Replacing the Guard Mode Switch Board.....	4-66
Replacing the Timing Board .....	4-68
Replacing the DSP/CPU Board.....	4-70
Replacing the Safety Board.....	4-72
Replacing the Main Reference Assembly .....	4-74
Replacing the Guard Board .....	4-76
Replacing the Low Voltage Power Supply Board .....	4-78
Replacing the Heater/Temperature Controller Board .....	4-80
Replacing the Optional Field Calibration Reference .....	4-82
Replacing the I/O Protection Board .....	4-83
Replacing the Transformer.....	4-85
Replacing the HV Pothead .....	4-91
Replacing the Fan Filter .....	4-93
Replacing the Fan.....	4-94

## Appendix A. M4000 Components Lists

M4000 Insulation Analyzer .....	A-1
Accessory Bag .....	A-2
Documentation Bag .....	A-4

## Appendix B. Warranty

RENTAL EQUIPMENT .....	B-1
PURCHASED EQUIPMENT .....	B-1
Limited Warranty .....	B-1
Software Limited Warranty.....	B-2
Limitations of Remedies .....	B-2
For Equipment Maintenance, Contact:.....	B-3

## Appendix C. Error Messages

M4100 Instrument Run Time Error Messages .....	C-1
--	-----

---

M4000 Firmware/Application Errors .....	C-2
M4000 Communications Errors.....	C-3

## **Appendix D. Part Numbers**

# 1. Introduction

The M4000 Insulation Analyzer is used to determine the insulation quality of high-voltage power apparatus in the field. This portable test set incorporates automated *Doble Testing* with high accuracy and sensitivity, over a wide range of values, and with minimal susceptibility to electrostatic interference and noise.

## Measurement Principles

The M4000 generates a 0-12 kV test signal with an internal sine wave generator, a 3 kVA power amplifier and a step-up isolation transformer. The M4000 then measures the voltage and current of the specimen and a reference impedance by periodically sampling instantaneous values with an A/D converter. The M4000 then calculates and reports test results by converting the sampled data into vector (magnitude and phase) quantities and applying conventional ac circuit theory. All reported results – including power loss, power factor and capacitance – are derived from the vector voltage and current.

The M4000 rejects interference through the judicious application of shielding, line-synchronized reversal, and line frequency modulation (FM). The first two techniques are similar to those employed in the earlier Doble M2H product line. The FM technique involves running tests at sinusoidal frequencies 5% (or even 10%, if necessary) above and below the line frequency and averaging the results. The choice is user configurable.

The inevitable interference current component is removed from the sampled data set before test results are calculated using synchronous detection. This is a mathematical process that separates out a single frequency component in a given signal. It is analogous to a bandpass filter centered at the test frequency. Synchronous detection is also useful for removing harmonic distortion and random noise in the test signal itself.

## Safety

The M4000 is designed to drive grounded and ungrounded specimens at lethal voltages and high power levels. Conventional ground-fault and current-limiting schemes cannot be used to protect the operator under these test conditions. Therefore, the M4000 implements special safety techniques to minimize risk to the equipment operator.

Both an operator and safety supervisor must be present when specimens are tested. Each person holds a safety switch that directly controls the output of the power amplifier through redundant electromechanical relays. In addition, the control processor can vote to disable the dc supply to the safety relay coils, thereby disabling the amplifier output if certain conditions are not met.

**NOTE**  
📌

**For greater safety details, see "Safety Practices – General Rules" on page 1-20.**

## M4000 Components

The M4000 Insulation Analyzer consists of the following components:

- M4100 Instrument
- M4200c Controller or Third-Party Controller
- M4000 Software

The following auxiliary components are optional:

- M4150 or M4151 Field Calibration Reference
- M4300 Transport
- Leakage Reactance Test Software
- External Reference Test Software
- DTA Software
- M4110 Leakage Reactance Interface
- M4120 External Reference Module
- Doble Standard Turns Ratio Capacitor
- Safety Strobe
- Temperature and Humidity Probe

## M4100 Instrument

The M4100 instrument supplies test voltage and test current to insulation specimens. The M4100 instrument also contains measuring circuits to determine the condition of the insulation under test, as well as direct control safety circuits to ensure electrical safety of personnel and test apparatus.

The M4100 instrument has a time base generator that may be synchronized either with the power system supplying power to the test instrument, or with an internal crystal oscillator. This choice allows the test operator to select one of two modes of test operation, Line Sync Reversal or Line Frequency Modulation. When Line Sync Reversal Mode is selected, the time base is synchronized to the power source and the test will use the standard Doble

polarity reversal technique to reverse the effects of electrostatic interference. Selecting the Line Frequency Modulation Mode of operation will synchronize the time base generator to the crystal oscillator. Two tests will be run for each programmed test sequence. The first test is run at a frequency of 57 Hz and the second test is run at 63 Hz. The measured test results of each test are combined and averaged to give a 60 Hz equivalent test result. When operating in the 50 Hz frequency, the same technique will apply. The first test will run at 47 Hz, and the second test will run at 53 Hz. This mode of test eliminates electrostatic interference from measurement, by avoiding measurement at power line frequency. It is also possible to select  $\pm 10\%$  of power line frequency as well. Safety circuits have been designed into the M4100 instrument to ensure safety of personnel. High voltage will not be supplied by the instrument if either of the following circuits and conditions are not satisfied:

- The ground safety circuit verifies that the #6 bare copper safety ground, which is attached from the instrument to the apparatus earth ground, is at the same potential as the power supply ground.
- Two safety switches must be attached to the M4100 instrument front panel and in the closed or depressed position prior to testing. One switch is held by the M4000 Insulation Analyzer operator and the second switch is held by a safety supervisor. The M4100 can be configured to require both switches to be opened between test sequences for the M4000 Insulation Analyzer to operate. Release of one or both switches will terminate the test sequence and high voltage potential.

A safety strobe light can be used in conjunction with the instrument and is plugged into the front panel of the M4100. Whenever high voltage potential is applied from the M4100, the safety strobe light will be energized and flashing. Safety strobe connection will be required in order to operate the M4000 Insulation Analyzer, unless the default system configuration has been modified to allow for the absence of a safety strobe. In this case, the strobe connector can be removed from the M4100 front panel.



*Figure 1.1 Safety Strobe*

Two optional items found on the M4100 front panel are the M4151 Field Calibration Reference, which will be discussed below, and a Temperature and Relative Humidity sensor. The Temperature and Relative Humidity Sensor will process temperature and humidity readings at the time of test.

Front Panel



*Figure 1.2 M4100 Instrument*

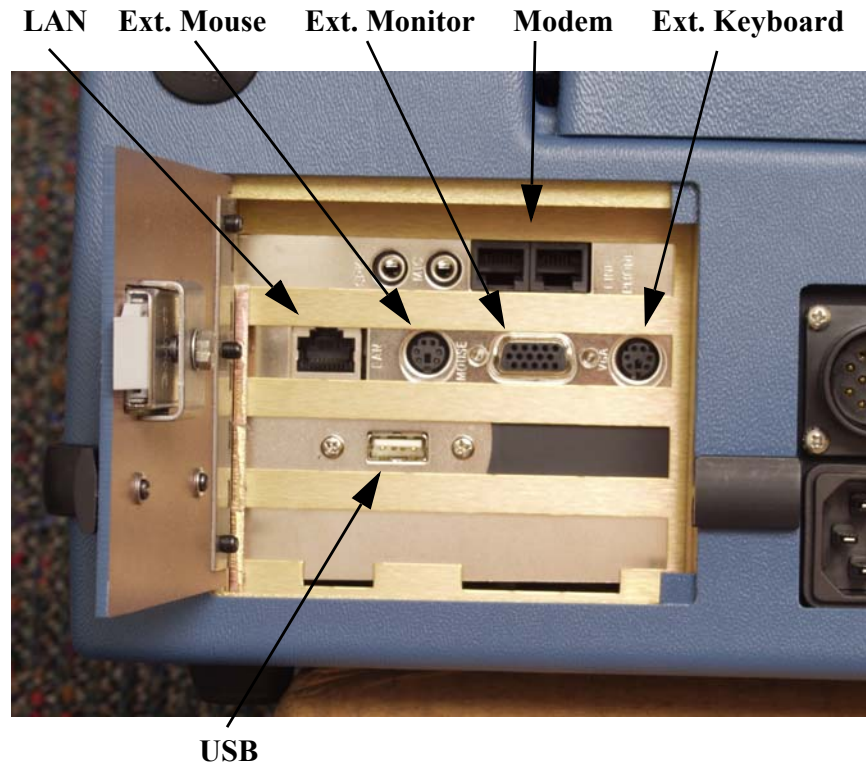
## M4200c Controller



*Figure 1.3 M4200c Controller*

- The M4200c Controller is the interface between the operator and the M4000 Insulation Analyzer. The color display, control, data storage, printing and communication functions are all provided by the M4200c Controller. This component is covered in detail in a separate manual.
- The M4200c has been specifically designed and built to operate in outdoor substations and other environments hostile to electronic test equipment. The unit has been hardened to electrostatic discharge (ESD) and radio frequency interference (RFI) to reduce or eliminate their effects on internal electronic circuits.
- The outer case of the M4200c is made of ABS plastic over an aluminum chassis that makes it rugged and suitable for transporting to remote sites.
- The display is a six-inch by eight-inch color transreflective liquid crystal display (LCD) that runs in the VGA mode. The display has high contrast in bright sunlight, and has backlight control for low ambient light conditions. An LCD heater is installed to allow for use in cold weather. An external monitor may be used in place of the LCD screen. Access to the external display connector is found behind the access door on the left side of the M4200c Controller.

- The keyboard is a standard notebook-type keyboard with a flexible skin around the keys to prevent dirt and moisture from contaminating the internal electronics and causing failure of the keyboard. An external keyboard may be used in place of this keyboard. Access to the external keyboard connector is to the right of the video connector behind the access door on the left hand side of the M4200c Controller.



*Figure 1.4 M4200c Controller External Connections*

- The M4200c has a pointer device installed below the keyboard on the front panel to allow for the use of mouse control of the display cursor. A port on the left-hand side of the M4200c allows for the use of an external, serial mouse.
- The M4200c has a built-in 200 dot per inch (dpi) graphic printer/plotter. Paper for the printer/plotter is an uncoated thermal FAX paper provided by Doble.
- The M4200c is equipped with an internal FAX/Modem board that may be used to transfer data when used with the optional Doble Test Assistant (DTA) program.
- The M4200c has a built in ethernet connection.



- The M4200c has a built in USB port.
- Data may be stored on an internal hard drive or on a 3 1/2 - inch floppy disk via the floppy disk drive located in the front of the controller.

### Third-Party Controller

Certain PC's using a Windows-based operating system available from other suppliers can be used as a system controller in lieu of the M4200c controller. These alternative machines can be used to control M4000 operations.

### M4000 Software

Software provided with the M4200c or available to be loaded onto a Third-Party Controller includes a program to run the M4000 Insulation Analyzer, and if desired, the optional Leakage Reactance Test, External Reference Test, and Doble Test Assistant (DTA) programs. For more information, refer to Chapter 2.

### Optional M4150 And M4151 Field Calibration References

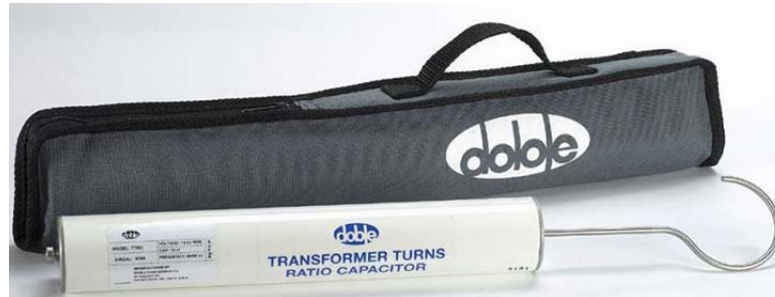
The purpose of the M4150 and M4151 Field Calibration References are to provide a means of obtaining System Status, Calibration Verification, and Field Recalibration Tests of the M4100 instrument in the field. (For an explanation of these tests, refer to "Running Diagnostics" on page 4-21). The Field Calibration Reference is mounted in the front panel of the M4100 instrument.



*Figure 1.5 M4151 Field Calibration Reference*

## Doble Standard Turns Ratio Capacitor

This is an optional small portable capacitor that can be energized at 10 kV for performing turns ratio tests at high voltages with the M4000.



*Figure 1.6 Doble Turns Ratio Capacitor*

## External Reference

This is an optional feature allowing the tester to test apparatus at their full operating voltage using the M4000, providing a suitable external power source and reference are provided by the user.

## M4300 Transport

The M4300 Transport is an option for the M4000 Insulation Analyzer that provides a means to move and store the M4000 system. It is also a platform for the field, from which the M4000 can be easily used and operated. Refer to "Storage and Moving Mode" on page 1-10 and "Testing Mode" on page 1-13. If a PC is to be substituted for the Controller, a support panel to be mounted on the Controller support frame can be supplied.



*Figure 1.7 M4300 Transport*

### **Doble Test Assistant (DTA) Software**

Optional Doble Test Assistant<sup>®</sup> (DTA) software provides standardized apparatus test procedures and templates, data management, and optional expert system software for insulation condition assessment. See Chapters 2 and 3 for further details.

### **M4110 Leakage Reactance Interface**

This optional interface contains the circuitry necessary to convert the voltage and current, measured during a Leakage Reactance test on a transformer, into a form that can be measured by the M4100 Instrument. It also contains a variac so that the proper test voltage can be obtained. The Leakage Reactance test cannot be made without either this Interface or the M4130 Leakage Reactance Module, and the accompanying software.

When using this interface, the standard M4000 safety switch and safety strobe are used. The necessary current and voltage cables are provided for connection to the transformer, along with the necessary software, so that this becomes a self-contained kit for this test. The user is only limited by the size of the variac provided.



*Figure 1.8 M4110 Leakage Reactance Interface*

## Operating with the M4300 Transport

The M4000 Insulation Analyzer is designed to be assembled on the M4300 Transport for storage, moving, and testing. When the M4000 is used with the M4300 Transport, it can be set up in the following modes:

- Storage and Moving Mode
- Testing Mode

## Storage and Moving Mode

The storage and moving mode will allow the user to transport and store the M4000 Insulation Analyzer. The M4300 Transport is designed so that all the components of the M4000 fit in a single, packaged unit (Figure 1.9).



**Figure 1.9 M4000 Insulation Analyzer in Storage Mode**

The recommended assembly steps for the Storage and Moving Mode is as follows:

1. Remove the M4200c Controller Support frame from the M4300 Transport. Lay the M4300 Transport down on its back, on a level surface so that the wheels and handle touch the surface.
2. Verify that the cover is installed on the M4100 Instrument front panel. Position the M4100 Instrument on the M4300 Transport as shown in the above picture.

3. Position the closed M4200c Controller upside down into the area with the projections of the top cover of the M4100 Instrument. Buckle and tighten the strap snugly around both the M4100 Instrument and the M4200c Controller.
4. Lift the M4300 Transport into the upright position.
5. Place the Documentation Bag and Cable Carry Bag on top of the M4100 Instrument top cover. Buckle and tighten the strap to secure.
6. Place the Oil Test Cell on the brackets provided between the wheels on the rear of the M4300 Transport, and secure it with the strap provided.
7. Place the High Voltage Cable into the brackets provided on the top, rear part of the M4300 Transport and secure it with the strap provided.
8. Place the M4200c Controller Support frame into the tubes provided so that the end faces forward.

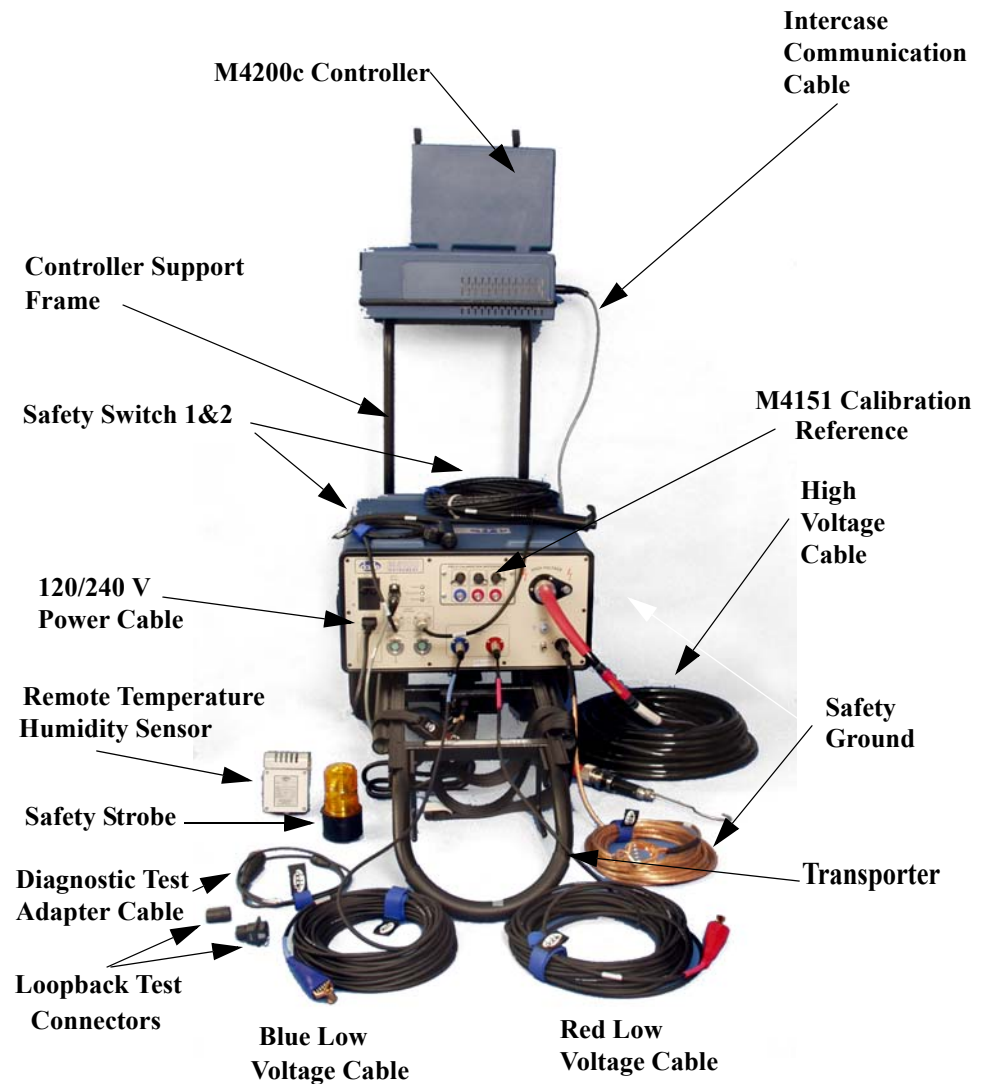
**NOTE**  
⚠

**The M4200c Controller Support frame should not be used for lifting the M4300 Transport.**

The M4000 Insulation Analyzer is now in Storage and Moving Mode.

## Testing Mode

When assembled in the Testing Mode, the M4300 Transport serves as the field desk for the M4000 Insulation Analyzer. The Testing Mode (Figure 1.10) was designed to take advantage of the M4100 instrument's concentrated cluster of connections, providing the user with a comprehensible testing setup and a user-friendly environment while testing.



*Figure 1.10 M4000 in Testing Mode*

The following instructions describe how to assemble the components of the M4000 Insulation Analyzer into the Testing Mode, from the Storage and Moving Mode:

**WARNING**



**When preparing for a test, do not attach any test leads to the apparatus to be tested without first attaching them to the M4100 test set!**

1. With the M4300 Transport in the upright position, remove the M4200c Controller Support frame, the Cable Carry bag, the Documentation bag, the High Voltage Cable, and the Oil Test Cell from the rear of the Transport.
2. Carefully lay the M4300 Transport down on its back on a level surface. The handle should face the specimen to be tested.
3. Place the M4200c Controller Support frame into the tubes provided on the M4300 Transport bottom plate, near the M4100 Instrument rubber feet. The top of the frame must extend away or opposite to the handle.
4. Remove the M4200c Controller from the top surface of the M4100 Instrument. Place the M4200c Controller on the Support frame and lock it in place.
5. Remove the top cover from the M4100 Instrument top panel. The M4100 Instrument is ready for connecting the cables.
6. The M4100 Instrument top panel receptacles are designed to only accept the functionally correct cables. Place each cable into the respective receptacle. The only interchangeable cables are the Safety Switches.

**NOTE**



**Inspect all cables for cracks or other damage before using.**

7. Connect the Safety Ground cable to the M4100 Instrument, and to the ground of the specimen to be tested. The Safety Ground Cable should be the **first connection to be made and the last one disconnected** from the M4100 Instrument.
8. Connect the M4100 Instrument and the M4200c Controller to the Power Receptacle Box located at the bottom of the handle of the M4300 Transport. A separate receptacle box is also provided for cases where the M4000 Insulation Analyzer is used away from the M4300 Transport. As shipped from Doble, the 120 VAC receptacle in the M4200c Controller is located under a yellow tag which states, “NOTICE: READ ENCLOSED MICROSOFT SOFTWARE LICENSE BEFORE USING”. The license agreement and documentation are in the Documentation bag. Please comply with the notice and remove the tag to plug in the cable.
9. Interconnect the M4100 Instrument and the M4200c Controller using the gray snap-in cable provided.



10. Connect the two safety switches to the two receptacles labeled “Safety Switches” on the front panel of the M4100 Instrument.
11. Connect, as necessary, the red and blue Low-Voltage leads to the corresponding color coded receptacles labeled “LOW VOLTAGE LEADS”, on the front panel of the M4100 Instrument. To avoid unintended measurements, connect only the low voltage lead(s) to be used for the next text.
12. Connect the Safety Strobe to the receptacle labeled “SAFETY STROBE” on the front panel of the M4100 Instrument. The strobe has a magnetic base that can be placed on a grounded steel structure, where it is visible to all personnel around the testing area.
13. Connect the Temperature and Relative Humidity Sensor to the receptacle labeled “REMOTE SENSOR” on the front panel of the M4100 Instrument. This sensor will automatically record the ambient temperature and humidity. The sensor has a magnetic base and should be placed on a grounded structure, in the shade, to record the most accurate temperature and humidity. The M4100 Instrument will operate without this option.
14. Connect the High-Voltage Cable to the receptacle labeled “HIGH VOLTAGE” on the front panel of the M4100 Instrument. Ensure that the High Voltage Cable is fully inserted and latched into the receptacle.
15. Connect the M4000 Power Receptacle box to a 120 or 240 VAC source.  
**This should be the last connection to be made.**
16. The M4000 Insulation Analyzer is ready to be connected to the specimen to be tested. Connections to the specimen are described in the *Doble Test Procedures* manual.

**NOTE**

When the M4000 Insulation Analyzer is assembled in the Test Mode it should not be moved. However if minor repositioning is necessary it should be done by lifting the M4300 handle a few inches off the surface.

**When Finished Testing**

When tests are finished, and before starting the Storage and Moving Mode assembly procedure, make sure that all the data have been saved and that the application programs that were used have been closed before shutting power off to the M4200c Controller.

**WARNING**

**When finished testing, do not remove any of the test leads from the test set before first removing them from the apparatus just tested!**

**NOTE**



**Data will be lost if all software application programs are not closed before the M4200c is powered down.**

To set the M4000 to the Storage and Moving Mode, reverse the previous setup procedure ("Testing Mode" on page 1-13), keeping in mind that the Safety Ground cable is the last cable to be disconnected from the M4100 instrument. Refer also to "Storage and Moving Mode" on page 1-10.

## M4000 PC Cable

There is a cable with connectors designed to attach your M4100 to a third-party controller of your choice. This cable is supplied as a way to offer users an even higher level of product reliability. With the M4000 PC Cable, the user can continue to test even if the M4200c Controller suffers a serious failure, by using the cable to connect the M4100 Instrument directly to the user's own PC.

To be prepared to use this cable, you must have the DTA and M4000 diskettes available to load onto your computer, and preferably a back-up copy of test data files as well.

### Third-Party Controller Requirements

- Pentium Celeron
- 64 megabytes of memory
- Windows 98 or later operating system
- Internet Explorer version 5.0 or better
- One available serial port

See the Doble website ([www.Doble.Com](http://www.Doble.Com)) for complete details.

### Setting Up the Controller

The computer must be loaded with the M4000 (and DTA, if a DTA user) software.

The COM port setting must be set in accordance with your computer's requirements. This can be done by selecting *Configuration* from the *Tools* menu and clicking the *Instrument* tab. The COM port is automatically set to the requirements of the M4200c Controller when you install the M4000 software. If you are using a Serial to USB converter, see "Instrument Configuration" on page 2-18. If you have the wrong COM port setting, you will get a communications error message when trying to run a test.

Besides the COM port setting, you must be sure no other program is running that wants to access this same COM port. Review programs located in your startup folder which start up each time the computer is booted up, and remove any that may try to grab the COM port. Or, from the System icon in the Control Panel, go to the Hardware tab and select Device Manager. Disable any items that require the selected COM port.

## Transport, Storage and Shipping

### Transporting and Storing the M4000

The M4100 Instrument, M4200c Controller, and Accessories should be stored in a reasonably clean and dry location. If the M4100 Instrument, M4200c Controller, and/or the inboard or outboard potheads of the High Voltage Test Cable are exposed to excessive dirt and/or moisture, they should be cleaned and dried before use. The inboard and outboard potheads of the Cable, and the cable pothead guide receptacle on the M4100 Instrument, could track along their surfaces if high voltage is applied while they are contaminated with surface dirt and/or moisture.

The M4100 and M4200c should be properly secured within the vehicle when being transported locally, and mounted in the normal upright position (preferably a location, in a van or truck, which is not directly above an axle of the vehicle). If a padded shipping container or trunk is not used when transporting the Instrument and Transformer locally, then protect against road vibration and bumps by having them mounted on shock absorbing material (2" to 4" of padding is desirable).

Avoid sharp bends in the High Voltage Test Cable when both using and transporting. The cable should be coiled into no smaller than a 12-inch diameter coil.

## Shipping Instructions

M4000 Test Set	<p>Always ship the M4000 and M4200c in separate containers.</p> <p>Ship in special packing cases provided by Doble or pack in cases with at least 4" of Styrofoam-type padding on all sides. The HV cable pothead-guide receptacle on the M4100 Instrument should be covered to keep out foreign material.</p> <p>On package, write: FRAGILE – PLEASE DO NOT DROP</p>
Accessory Case	<p>Pack leads, cables, and accessories in the cable bag furnished with the set.</p>
Liquid-Insulation Cell	<p>The Cell and Plastic Carrying Case must be thoroughly cleaned to prevent accidental contamination of the Accessory Case and the environment. If the Accessory Case is either not shipped or is too full, then the clean Cell and Carrying Case should be shipped in a separate padded cardboard box, or better. Padding should be installed inside and around the Cell.</p> <p>On package, write: FRAGILE – PLEASE DO NOT DROP</p>

**NOTE**



**When shipped by commercial carrier, the M4100, M4200c and Accessories should be properly padded and packed as specified above. Suitably padded shipping containers for temporary use or purchase are available from Doble upon request.**

Ship to:

Doble Engineering Company  
85 Walnut Street  
Watertown, Massachusetts 02472-4037  
USA

**NOTE**



**Test sets that are transported appreciable distances should be checked upon arrival. This includes sets that have been shipped from the Doble Engineering Company. The test set and its accessories should be examined upon receipt for signs of physical damage. The simplest and most effective method for checking overall performance of the M4000 is to use the Doble Liquid Insulation Cell as described in "Checking Instrument Accuracy in the Field" on page 4-43.**

The preceding also applies to test sets that have been stored for prolonged periods.

## Safety Considerations

Safety cannot be overemphasized when working on or around high voltage electrical apparatus. Companies that generate, transmit, distribute, or utilize high voltage electricity should, and do, have precise rules for safe practices and procedures for personnel whose working responsibilities involve testing and maintenance of the various types of high voltage apparatus, and their associated lines, cables, and conductors, as well as the associated accessories.

## Definitions

Throughout this manual, reference will be made to testing personnel in certain general terms which are defined below. These terms apply only to the testing function of the individuals and not to their professional status, seniority, or positions within their company's structure or personnel hierarchy. These terms are:

- *Test Set Operator* – The person who supervises the test and operates the M4000 Insulation Analyzer.
- *Operator's Assistant* \* – The person who follows the operator's instruction in making test connections.
- *Safety Observer* \* – The person who is responsible for observing the performance of the test, seeing any safety hazard, and giving warning to crew members.

\* The operator's assistant, or the safety observer, may be employed to operate the extension safety switch and to act as safety supervisor. The operator of the safety switch should perform no other work, such as recording test data, while the M4000 Insulation Analyzer is energized.

Two safety switches are provided and are required to be operated in order to energize the M4000 Insulation Analyzer. The M4000 Insulation Analyzer generates high voltage and is capable of causing serious, even lethal, electrical shock. The M4000 Insulation Analyzer should not be operated by a crew smaller than two people. A larger crew may be desirable under some circumstances. Regardless of crew size, one person should be designated as the *Test Set Operator* and one other as *Test Supervisor*.

- *Test Supervisor* – This person is responsible for overseeing preparations for the test sequence, overseeing M4000 Insulation Analyzer operation, and ensuring that all safety precautions are put into practice. Safety practices followed should include company policies, applicable government regulations, and any special requirements related to use of the M4000 Insulation Analyzer.

## Safety Practices – General Rules

1. All tests should be performed with the apparatus under test completely de-energized and isolated from its power systems. This means disconnecting and grounding all bus from the apparatus under test.
2. The method of testing high voltage apparatus involves energizing the apparatus through the M4000 Insulation Analyzer. The act of testing apparatus, which is otherwise de-energized and isolated from its system, can itself produce dangerous levels of voltage and current. Care must be taken to avoid contact with the apparatus being tested, its associated bushings and conductors, and with the M4000 Insulation Analyzer cables.
3. The test crew must make a visual check to ensure that the apparatus terminals are isolated from the power system. Where the possibility of failure of the apparatus under test must be considered a real possibility, precautions (such as barriers or entrance restrictions to test area) must be taken against harm in the event of violent failure.
4. All rules of your company for safe practice in testing must be strictly conformed to, including all practices of tagging and isolating apparatus during testing and maintenance work. State, local, and federal regulations, e.g. OSHA, may also apply.

**NOTE**  
⚠

**Company rules and government regulations take precedence over Doble recommendations.**

## Clearances

Proper clearance between the test equipment, crew members, and the apparatus being tested, must be observed at all times during energization. Barriers, safety tapes, and ladder barriers should be erected around the test area to prevent unintentional (or intentional) entry into the “live” area. These same precautions should be taken to block unwitting entry into the area by means of ladders, buckets, or any other extraneous equipment by which entry into the area may be gained.

## Grounding

1. The apparatus under test, its tank or housing, and the M4000 Insulation Analyzer must be solidly and commonly grounded or earthed. This also applies to any mobile equipment being tested.
2. When the M4000 Insulation Analyzer is permanently housed in a vehicle, the M4000 Insulation Analyzer ground should be bounded to the vehicle chassis, which in turn is grounded.
3. Exposed terminals of apparatus should not normally be allowed to “float”. They should be grounded directly or through the low voltage leads of the M4000 Insulation Analyzer, unless otherwise specified by Doble recommended test plans.
4. There must be two inches of clearance between conductors (such as bus) that are not part of the tests.

## Personnel Safety

1. A pretest tailgate meeting is recommended. Frequently, other crews will be working on non-test related tasks in close proximity to equipment being tested. The tailgate meeting should include all personnel who will be working in proximity to the area where testing will be performed. In this meeting, the tests to be performed, the apparatus and the voltage test levels involved, potential hazards involved with the work, and the individual assignments should all be reviewed with the crew members. Test personnel need to remain aware of the work activity taking place around them and alert to the possibility that non-test personnel may enter the test area.
2. A consistent and uniform set of signals, both visual and verbal, should be agreed upon, and should be followed by all of the crew members during testing.
3. While making the various types of connections involved in the different tests, it may be necessary for personnel to climb up on the apparatus, but no one should remain on the apparatus during the test itself.
4. The HV Test Cable should not be held during energization of the M4000 Insulation Analyzer. Flashover of the test specimen or the M4000 Insulation Analyzer can generate transient voltages of sufficient magnitude to puncture the insulating jacket of the cable.

## M4000 Connections

**WARNING**



1. The procedures described in the “Testing Mode” section of this chapter on page 1-13, for connecting and disconnecting the M4000 leads in their proper sequence should be observed and acted upon at all times.

**In particular, due to the presence of static charges from nearby energized lines, never touch the live end (hook) of the high voltage cable when moving leads. Never hold the High Voltage cable during a test.**

2. Test personnel should be aware that induced voltages or trapped charges may be present on the equipment about to be tested. EHV circuit breakers with grading capacitors across the interrupter contacts are especially prone to build up a high voltage charge. Voltages high enough to damage the M4000 Insulation Analyzer have been known to occur on this type of equipment. Provisions should be made for draining these charges by applying grounds prior to making your test connections. It is a good practice to ground equipment such as capacitors, capacitor voltage transformers, and EHV circuit breaker heads as soon as they have been isolated for testing, and to temporarily remove the grounds only during the short period when tests are actually being performed.
3. Perform only one job at a time on any apparatus. The situation in which two crews are doing different tasks with the same apparatus at the same time is an open invitation for confusion, trouble and danger to the personnel.



## M4000 Operation

1. Both safety switches must be used in order to activate the test setup. One is to be controlled by the M4000 operator and the other by a second test crew member, designated the safety supervisor. (This person may be either the *Operator's Assistant* or the *Safety Observer*.)
2. The *Test Set Operator* or the *Safety Observer* must be able to have an unobstructed view of the terminals of the equipment under test, any points of entry into the immediate test area, and of the workers in the area.

## M4000 Safety Features

The M4000 Insulation Analyzer is equipped with a ground-relay scheme, which prevents test voltage from being applied until the following preliminary conditions have been established:

1. A #6 copper conductor is provided by Doble for the purpose of grounding the M4000 Insulation Analyzer. The heavy-duty #6 conductor should be connected to the **GROUND RECEPTACLE** of the M4000 Insulation Analyzer at one end and to the station grounding system at the other end. ***This should be the first step in setting up the M4000.***
2. After the M4000 Insulation Analyzer is properly grounded, the remaining test leads and the HV Test Cable are plugged into their receptacles. ***Do not connect test leads to the apparatus terminals until after the leads are connected to the M4000.***
3. The power cord should be plugged into a 120V ac or 240V and grounded receptacle. ***This should be the last step in setting up the M4000.***
4. Two separate grounds are required to pick up the ground relay and operate the M4000: one as described in item 1 above, and the other through the third wire of the 120/240 volt supply cord. Care should be taken to ensure that there is no direct contact between the two grounds. Short circuiting the two grounds together may create a hazardous condition if the ground connection is inadvertently interrupted.
5. The HV Test Cable used with the M4000 is a double-shielded cable in which the high voltage is exposed only at the outboard pothead tip. The HV Test Cable should not be handled while it is energized. If a flashover occurs while testing, transient voltages higher than 10 kV can appear on the cable and puncture the insulating jacket of the cable, creating a hazard to personnel holding the cable. The cable may be suspended or tied off in such a way as to avoid handling.

6. The M4000 includes a safety strobe with a magnetic base that can be placed on a grounded steel structure where it is visible to substation personnel. The safety strobe is enabled and required to be connected when running a test by default. Although this can be defeated in the process of instrument configuration, this should be done only if the strobe is not working and cannot be used.
7. During operation, an audible beep is heard whenever high voltage is being applied. This beeper is enabled by default. Doble recommends the default, although the beeper can be turned off as part of instrument configuration.

**WARNING**



**The M4000 Insulation Analyzer is heavy. The M4100 Instrument alone weighs approximately 100 pounds (45 kg). Doble recommends that at least two persons be used to move the M4100 in the field. Special care must be taken in lifting the M4100 into or from a vehicle to avoid bodily injury.**

## Safety Precautions

Doble insulation analyzers require operation by at least two persons. The M4000 Insulation Analyzer operator has his/her own Operator's Safety Switch. A second switch, called the Extension Safety Switch, is provided. The cable for the Extension Safety Switch is equal in length to the High Voltage Test Cable. Both switches are of the spring-release type for quick action. With either switch off, all voltage to the High Voltage Test Cable is removed. The person responsible for attaching the High Voltage Test Cable to the specimen should operate the Extension Safety Switch, and should be positioned so as to be able to observe all terminals and points of access to the apparatus under test. If this is not possible, then the out-of-sight terminals should be roped off with **CAUTION** labels appropriately placed, and a person posted in the vicinity to ensure safety.

Each time the test equipment is set up, and prior to making the first test, both safety switch operators should cooperatively verify the correct operations of both switches.

It is recommended that the Extension Safety Switch be the last switch closed. The Extension Safety Switch must remain open until all personnel are safely in the clear. **Personnel should not be allowed to remain on the apparatus while tests are in progress.** If unauthorized personnel should enter the area, or if some other undesirable situation should develop, the Extension Safety Switch operator should release the switch immediately, and then notify the M4000 Insulation Analyzer operator.

The two safety switches are intended to be used as a “dead man” type switch. **Both safety switches should be used at all times. Never short circuit them and do not use fixed mechanical locking devices for depressing the switch button. The switch button must be manually operable at all times.**

The M4000 operator and the operator's assistant should follow a uniform system of visual and verbal signals in order to prevent confusion during the testing process. For example, when the test connections have been completed and all personnel are in the clear, the operator's assistant should make visual contact with the M4000 operator and call “ready”. The M4000 operator, before bringing up the test voltage, should acknowledge the assistant's signal, and advise all present by calling out “coming hot”. Upon completion of the test, the operator should call out, “all clear”. To demonstrate further that the test has been completed, it is good practice for the M4000 operator to extend the Operator's Switch at arm's length with the button released, for all to see.

After the tests are completed, all test leads should be disconnected first from the equipment terminals and brought down to ground level before they are disconnected from the M4100 Instrument. ***The #6 copper test set ground should be the last lead to be disconnected from the set.***

**WARNING**



**Never attempt to disconnect the HV Test Cable or the Low Voltage cables from either the terminals of the test specimen to which they are connected at the outboard end, or from the receptacles on the M4100 instrument at the inboard end, unless the M4000 VOLTAGE CONTROL is set to ZERO, and the Operator's Safety Switch and the Extension Safety Switch are both released. Attempts to disconnect leads while the M4000 is energized may result in a serious, and possibly lethal, electrical shock.**

## Safety Precautions for Various Types of Apparatus

In addition to the items included in "Safety Practices – General Rules" on page 1-20, the following are specific considerations that have to do with the testing of various types of apparatus:

### Bushings

When performing either single or multi-hot-collar tests using rubber Hot Collars, be aware that the rubber collar is a conductor, and that it is at the test voltage during the test.

### Breakers

Prior to any testing, steps should be taken to disable the breaker so as to avoid inadvertent operation during testing. In a closed breaker test, both bushings will be energized at test potential, and contact between the bushings and either test personnel or test leads should be avoided.

When testing lift-rods, operating rods, or any component internal to the breaker, the operating mechanism should be blocked, fuses removed, and any other necessary measures taken to ensure that the breaker is inoperative.

### Transformers

1. When performing bushings tests, the opposite windings should be grounded.
2. When performing excitation tests, floating terminals should be considered live.
3. Use caution when applying test voltages to a transformer from which the oil has been removed. Recommended test voltages for testing a transformer without insulating fluid are listed in the *Doble Test Procedures* manual.
4. Under no circumstances should test voltages be applied to oil impregnated insulation while the insulation is under vacuum.

Instrument Transformers	In addition to isolating and grounding live terminal(s) of the primary winding, secondary fuses and other leads should be removed in order to completely and effectively isolate the unit from the system. This is especially important in the case of potential transformers.
Voltage Regulators	Check to ensure that there are no closed secondary links in order to eliminate the possibility of backfeed.
Surge Arresters	Everyone is instructed to stand clear during the testing of surge arresters because of the possibility of their violent failure.
Capacitors	<ol style="list-style-type: none"><li>1. Close all the grounding switches on the device housing in order to ground the bottom terminals of the capacitor.</li><li>2. Make sure capacitor stacks are discharged before you come into contact with them. Internal resistors should not be relied upon for discharging individual capacitor cells. Capacitors intended for usage may not contain internal resistors. Resistors in failed capacitor cells should be considered suspect. For additional protection, it is recommended that the terminals of individual cells be discharged before personnel come in contact with them.</li></ol>

## Safety Summary

In summary, it is worth noting that many of the accidents that happen around high voltage apparatus and its associated conductors involve personnel who are familiar (perhaps too familiar) with high voltage equipment. Staying alert and ever watchful requires constant training and awareness of the inherent hazards.

The greatest hazard is the possibility of getting on a “live” circuit. To avoid this requires constant vigilance – for oneself and for one's fellow workers.

In addition to the obvious dangers, personnel should be alert to recognize subtle dangers as well. For example, during transformer excitation-current tests, the “floating” terminals may have significant voltages induced in them by simple transformer action. Thus, all terminals of an apparatus under test, unless grounded, should be considered to be “live” while the test is in progress.

In the case of potential transformers or any transformers which may be interconnected, voltage can be back-fed through the secondaries to produce high voltage on the primary, although the primary is seemingly isolated from the power system. This re-emphasizes another rule: *All terminals of an apparatus to be tested should be completely isolated.*

**Remember: SAFETY**

**.....FIRST, LAST, ALWAYS!**

## 2. M4000 Software

### Upgrading or Installing M4000 Software

Your M4200c Controller comes with all necessary software pre-installed. This consists of the Windows XP operating system, the M4000 program, and for users of the Doble Test Assistant, the optional DTA program. You may also request the optional Leakage Reactance Test or External Reference Test software. You may need to install this software if you are loading it onto an office computer or laptop, upgrading from a previous version, or reinstalling it. This chapter covers the following subjects:

- Installing M4000 software on your PC.
- Introduction to M4000 Software/Icon Descriptions/Configuration Settings (see page 2-6)

### Software Installation

#### WARNING



**Before starting, BACK-UP YOUR TEST DATA**

#### NOTE



If you have customized limit files, location.txt, and division.txt files from DTA, save them separately, so you can transfer the data to the new version.

### M4000 Software

#### NOTE

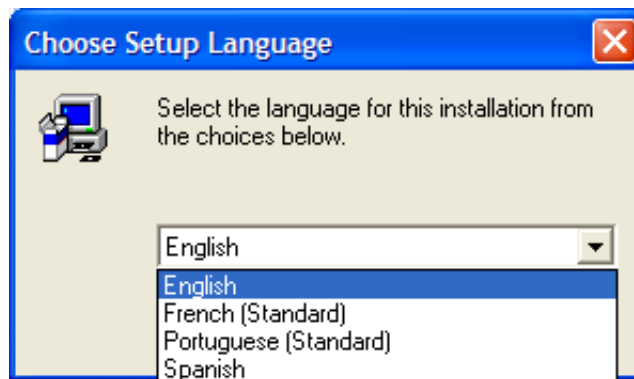


**The first time a test is run with newly installed software, the M4200c Controller or your laptop computer being used as a Controller must update the M4100 Instrument firmware. The user is notified of this process by the message, “Downloading firmware to the M4100 Instrument – Please wait”. Do not interrupt this process. Otherwise, the previous version of the software must be reloaded onto the M4200c or your laptop, then the new version installed once again.**

This section contains the steps to follow to install the M4000 software.

If you have already installed the current version of the M4000 software, and you only wish to add either or both of the optional features, Leakage Reactance and External Reference/Source testing, each of these disks contains its own setup function and can be installed separately as described below. To install the M4000 software and/or either of the optional features, follow this procedure:

1. Make sure all your existing test data is backed up!
2. In Windows, select the “Run” option from the **Start** button menu. The Run dialog box appears.
3. Insert the installation diskette in the A: drive (or CD into its drive).
4. Type the following in the Run dialog box: **A:\setup** (or corresponding drive letter for the CD drive), and press the ENTER key.
5. Select the language for the installation instructions. After installation, any of the listed languages can be chosen at any time from the *Advanced* tab of the *Tools/Configuration* window, as long as they have been installed in step 8 below.



*Figure 2.1 Language Options*

6. The program will ask in which directory to install the M4000 Software. It is recommended to stay with the default settings. Note that it is different from the existing version, so that you may use either version on the same computer. Press the ENTER key.

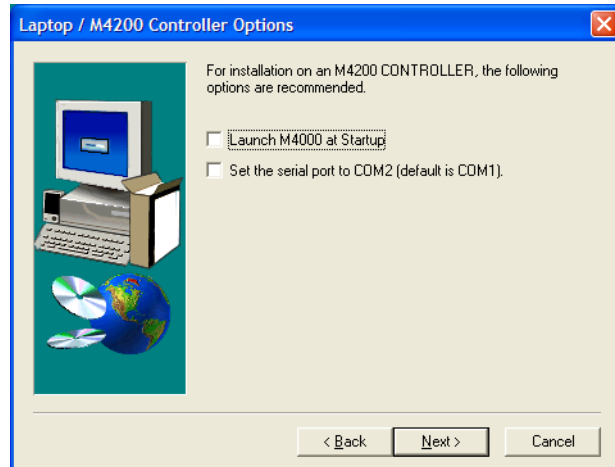
**NOTE**  
☞

**Optional Leakage Reactance software must be installed in the same directory; the optional DTA software may go in its own directory.**

7. You will be asked to select some installation options:

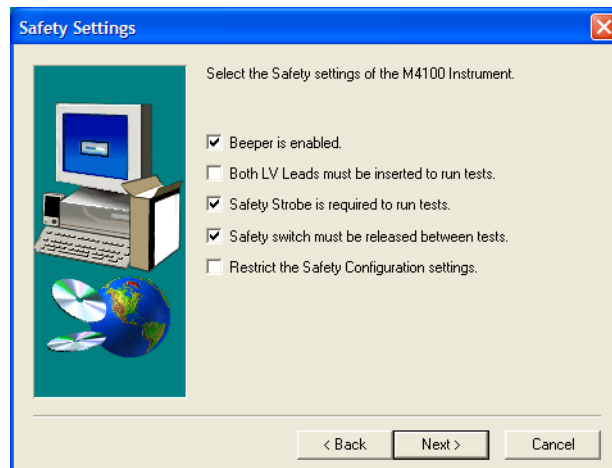


- **Launch M4000 at Startup:** Select this option if this computer is dedicated to M4000 tests, since it automatically runs the M4000 program when starting the computer (If you have the icon for the old version of the software in your startup folder, remove it).
- **Set the serial communications port to COM2:** select this only if installing the software on an M4200c controller.



*Figure 2.2 M4000 Software Installation Options*

8. You will then be asked to select safety options:



*Figure 2.3 Safety Settings*

- **Beeper Is Enabled:** Enables the audible warning feature that signals the beginning of each test (recommended).

- **Both LV leads must be inserted to run test:** requires that both the red and blue leads be inserted into the test set to run a test (rarely used).
- **Safety strobe is required to run test:** In the event there is a failure of the strobe bulb or cable, this should be disabled so as to be able to continue testing without it.
- **Safety switch must be released between tests:** Serves to discourage user from artificially holding safety switch down for the duration of several tests.
- **Restrict the Safety Configuration settings:** If selected, serves to lock the above 4 selections so that they cannot be changed from within the application.

**NOTE**

Use this last option with care, since if a need arises to change one of the above settings (a burnt out strobe light bulb), you cannot change the settings and continue testing without reinstalling the software.

9. A screen will appear where your company name, as you wish it to appear in the Nameplate area, can be input. Leave it blank if you prefer to fill the name in manually each time.
10. Finally, you will be asked which languages you wish to have installed on the computer. You may choose English, French, Spanish, and Portuguese, and different users may switch among them from the *Tools/Configure/Advanced* menu.



*Figure 2.4 Languages Installed*

11. If using diskettes, insert subsequent disks when prompted and press the ENTER key.
12. You will be asked if you wish to read the “readme” file.

13. Since you are able to have both the old and new versions on the same computer, you may wish to be able to switch back and forth at first. To avoid downloading firmware to the M4100 each time you switch, do the following:
- Find the M4i.x0, Bootblok.x0, and Loader.x0 files in the directory where the new version 3.0 is installed (the default is C:\Program Files\Doble\M4000).
  - Copy these 3 files into the directory of the older version you are using.

Installation of the M4000 Software is now complete.

### **Doble Test Assistant (DTA) Software (Optional)**

See instructions found with the DTA software.

## **Optimization**

### **COM port Setting**

If the software has been installed on a PC, you may have to adjust the COM port setting if the wrong choices were made during installation. If you are not able to run any tests on the M4000, but get a communications error, proceed as follows:

1. Select Tools/Configuration, and choose the *Instrument* tab.
2. Set the Serial Port to COM 1.
3. Make sure the baud rate is set to 9600.
4. Click OK, reboot the computer, and try again.
5. If there is still trouble communicating, your laptop may require another choice. Possible COM port choices are 1, 2, 3, or 4.

Besides the COM port setting, you must be sure no other program is running that wants to access this same COM port. Review programs located in your startup folder which start up each time the computer is booted up, and remove any that may try to grab the COM port. Or, from the System icon in the Control Panel, go to the Hardware tab and select Device Manager. Disable any items that require the selected COM port.

### **Mouse Settings**

You can modify the mouse settings for maximum visibility on the M4200c Controller:

- From the Windows “Start” button, choose “Control Panel” from the “Settings” menu item.
- Double-click on the Mouse Icon, then select the “Motion” tab.
- Click the “Show Pointer Trails box, adjust the scale marker to “Long” and click OK. This will cause the mouse to leave a trail behind it when moved, and increase visibility in bright sunlight.

## Time/Date Format

You may want to change the time/date format. The default is mm/dd/yyyy for date, and 12 hour format for time. To change this format, Select “Control Panel” from the Windows Start button menu. Time and date format can be changed from the “Date and Time” icon, and this change reflects through to the M4000.

## Introduction to M4000 Software

### What’s New

Aside from some behind the scenes changes to make this program a modern up to date 32 bit program, here are some features visible to the user:

#### Clipboard

1. The clipboard now has 200 lines instead of 36, so that almost any type of testing should be able to fit in one single file.
2. The M4000 program now supports English, French, Portuguese, and Spanish.
3. *Serial Number* and *Manufacturer* fields have been added to the nameplate area.
4. The column widths on the test grid are user-configurable.
5. For each test, time, date, air temperature, and humidity are recorded and can be viewed.
6. A new file structure has been implemented, allowing user-specified file names for easier data manipulation.
7. The printout now has a grid around the data, for a more professional look.
8. The Clipboard mode now has graphing capabilities (see ”Graphing Test Results” on page 3-11).
9. The Clipboard mode now offers automatic temperature correction (see ”Temperature Correction” on page 2-12).

- Leakage Reactance      **10.** One Leakage Reactance file can now contain all tests in a series: Three Phase Equivalent, Per Phase, and tests on different taps. Data entry is now more intuitive.
- External Reference      **11.** On the External Reference form, both UST and GST tests can be stored all on the same form.
- 12.** You may now store reversal readings on the same line and automatically average the results.
- 13.** You may now store test circuit loss associated with the GST test, and the program will automatically subtract the loss from the test results.



## The M4000 Program






To start the M4000 Software: turn on the M4200c Controller; or, if using your laptop, and the program executable is not in your “StartUp” group:

1. Select *All Programs* from the Windows *Start* button menu.
2. Select the *Doble* Program Group.
3. Select the *M4000* icon.
4. Click the OK button on the “About The M4000 Software” window. You are now at the M4000 clipboard screen. The menu bar contains a number of choices, with a row of short-cut icons just below.

## Icons

Before step 4 above, the basic icons shown and their functions are described as follows:

Icon	Description
	Open M4000 data file. New M4000 files have the extension .m4k, but old M4000 files can also be opened using this command.
	Exit the M4000 Software, or select Exit from the File pull down menu.

Icon	Description
	Enter DTA Field System Software, or select DTA from the Mode pull-down menu. With DTA, the second test mode available is DTA. See the DTA instruction manual for use of the DTA option. DTA contains specific forms for different apparatus types, along with an expert system to evaluate results. Since this is optional software, this icon will not be active if DTA software is not installed.
	Enter Clipboard Mode or select Clipboard from the Mode pull-down menu. Without DTA, the only test mode is Clipboard. The clipboard mode is described further in this chapter. It provides a generic form for testing any apparatus.
	Enter External Reference/Source Mode, or select External Reference/ Source from the Mode pull-down menu. Since this is optional software, this icon will not be active if External Reference software is not installed.
	Enter Leakage Reactance Test Mode, or select Leakage Reactance Test from the Mode pull-down menu. Since this is optional software, this icon will not be active if Leakage Reactance software is not installed.
	Find help, or press the F1 key, or select the items from the Help pull-down menu item. Help is described in the 'Using Help' section of Chapter 1.

## Menu Bar

The Menu Bar functions are described as follows:


**Mode:** Allows selection of available test modes. Clipboard is automatically included with the M4000 software. External Reference/Source, Leakage Reactance, and DTA are optional software add-ins.

**Diagnostics:** These help you check the status of the M4000 Insulation Analyzer, and to diagnose any problems that may exist. See "Running Diagnostics" on page 4-21 for a description of this item

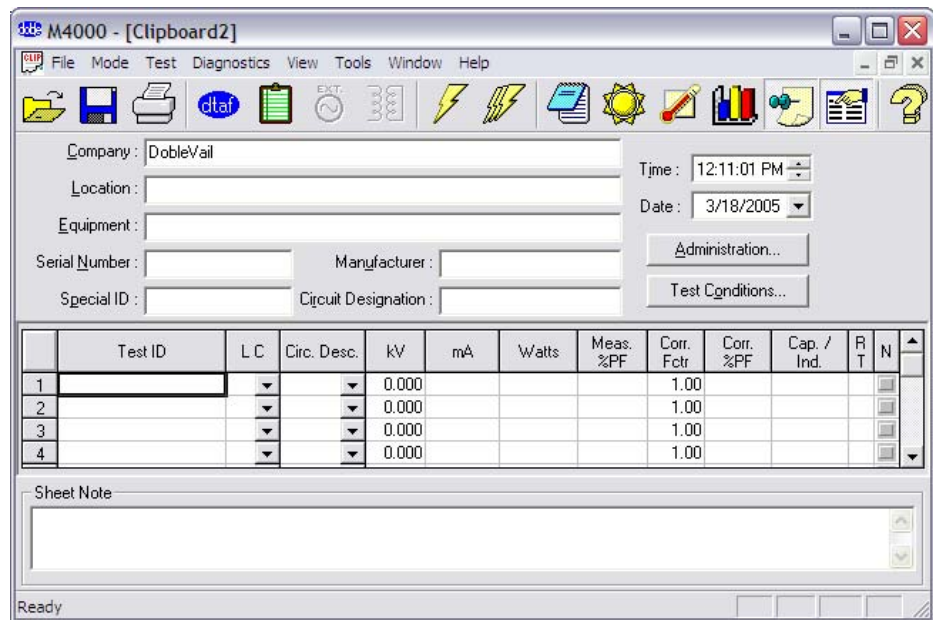
**View:** De-selecting an item from this menu will remove the icon bar from your screen. Select again to restore it.

**Tools:** Here you can clear test and nameplate data, view a test note or temperature/humidity data, or adjust configurations. See the "Configuration" section in this chapter for a full description of these options.

## Clipboard Test Mode

To enter Clipboard test mode, click the  icon, or select Clipboard from the Mode pull-down menu item.

The following screen will appear:



*Figure 2.5 Clipboard Screen*

Clicking on the following icons will perform the described functions:

### Icon

### Description












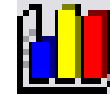
Open a File. If a Clipboard file is saved, it can be retrieved by clicking on this icon, pressing F9, or selecting Open from the File pull-down menu.



Save a File. This can also be done by pressing CTRL+S to save the file with the existing name, or the F8 key to save with a new name.



Print the current Clipboard form. This can also be done by selecting Print from the File pull-down menu item, or by pressing F7.

Icon	Description
	Enter the DTA Field System program. This can also be done by selecting DTA from the Mode pull-down menu item.
	Click to open a Clipboard screen, where tests may be run and recorded.
	Click to enter External Reference/Source Mode, or select External Reference/ Source from the Mode pull-down menu.
	Click to enter Leakage Reactance Test Mode, or select Leakage Reactance Test from the Mode pull-down menu.
	Run a single test. This can also be done by selecting Run A Single Test from the Test pull-down menu item, or by pressing F2.
	Run a multiple test. This can also be done by selecting Run A Multiple Test from the Test pull-down menu item, or pressing FN+F11.
	Enter a note. When clicking on this icon, the software will ask you which line the note corresponds to. The default is for line. This can also be done by selecting Edit Test Note from the Edit pull-down menu item.
	View the air temperature and percent humidity associated with each line of test data. This can also be done by selecting Display Temp./Humidity from the Edit pull-down menu item.
	Allows user to activate automatic temperature correction function for the clipboard test mode.
	Graph the selected clipboard results



**Icon****Description**

Toggle sheet note. Click this icon to display or hide a note area for the entire clipboard sheet at the bottom of the screen.



Toggle Nameplate. Click this icon to display or hide all but the test data. This allows the user to hide or display the Nameplate information, time, date, Administration and Test Condition buttons.



About M4000 For Windows. This can also be chosen by selecting About M4000 For Windows from the pull down menu item.

**NOTE**

**If you are using the pull-down menus and wish to remove these icons, click on the View pull-down menu item and then click on Toolbar. This will disable the icons. They can be retrieved by repeating the same action.**

## Menu Items

The menu items are **File, Mode, Test, Diagnostics, View, Tools, Window,** and **Help**. The principal functions included under these items are better accessed by using the icons described in the previous paragraphs. The features under what used to be the Edit menu are now found under **Test** by selecting the Clear menu item. The **Diagnostics** commands are described in Chapter Six, *M4100 Instrument*.

## Mode Menu

Select the type of test desired. Choices are:

- Clipboard (for Power Factor, Exciting Current tests)
- Leakage Reactance (Requires optional software)
- External Reference/Source (Requires optional software)
- DTA (Requires optional software)

## Test Menu

This menu contains the start single test (F2) and start multiple tests (F11) commands.

## Diagnostics

This menu contains several self-test options, described in "Running Diagnostics" on page 4-21.

## View Menu

Commands here allow display or hiding of the:

- Toolbar (row of icons)
- Status Bar (along the bottom of the screen, it includes status of the Caps Lock and Num Lock functions, which should be off)
- Nameplate data fields
- Sheet note located just above the Status bar at the bottom of the screen.

## Tools Menu

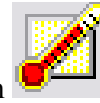
This menu includes the following:

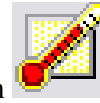
- Insert a test line command, inserts a new row above the row in which the cursor sits.
- Remove an empty test line removes the empty line on which the cursor sits. If the line is not empty, a warning message appears.
- Clear command for test results, nameplate data, test note, and sheet note
- Test Note command, which allows access to individual test notes for each line of test data
- Temp and Humidity command, which allows access to the temperature and humidity readings for each line of test data.
- Temperature Correction, as described below, enables the user to select the type of apparatus under test so as to activate automatic temperature correction.
- Graph results command, allowing the user to select test results on the clipboard and graph them.
- Configuration settings for both the software and the instrument, described under "Configuration" on page 2-13.

## Temperature Correction

To activate automatic temperature correction:

1. First, run your tests and fill in the rows with the results.



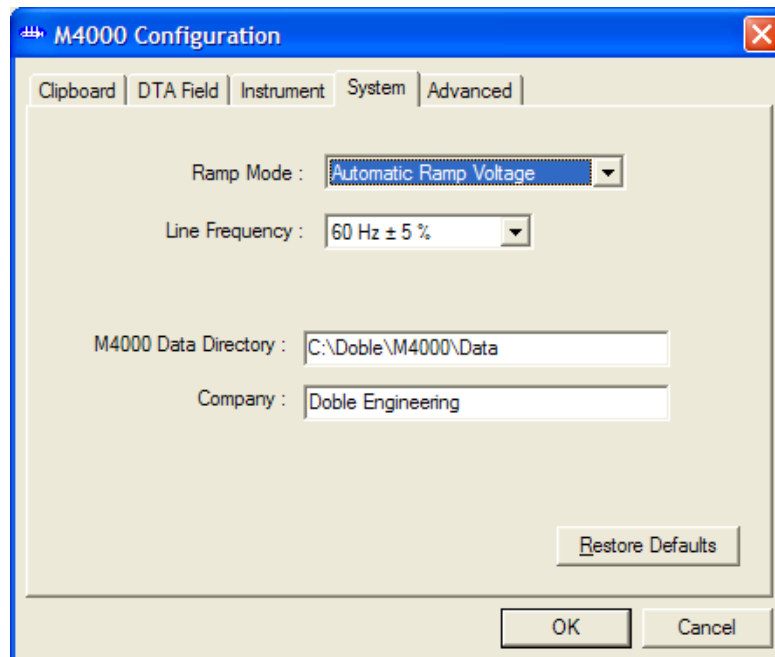
2. Click the temperature correction icon , or select *Temperature Correction* from the *Tools* menu.
3. In the Temperature Correction window, fill in the rows on the clipboard screen to which you wish to apply the temperature correction. These rows must have temperature data associated with them for this function to work.
4. Select the Equipment Type and Sub-types where applicable.
5. Click OK, and Clipboard will apply the appropriate correction factor to the selected rows of test data.

## Configuration

There are five option tabs available in the M4000 Configuration window, accessed from the View menu item. They are System, Clipboard, DTA, Instrument, and Advanced.

### System Configuration

When selecting the System tab, the following appears:



*Figure 2.6 M4000 System Configuration*

**Ramp Mode** - Auto Ramp Mode raises the voltage automatically at a rate selected separately in the Clipboard Configuration and DTA Configuration. Manual Set Voltage allows raising the voltage by pressing the PGUP key to raise the voltage rapidly, the PGDN key to lower the voltage rapidly, the up arrow key to raise the voltage slowly, and the down arrow key to lower the voltage slowly. The rates at which the voltages are raised and lowered manually are selected separately in the Clipboard configuration and the DTA Configuration.

**Line Frequency** - Select the frequency that corresponds to the user's system; or, if trying to duplicate a test result made at another frequency, select either frequency. Under normal system conditions, make the  $\pm 5\%$  selection. If your power line frequency is itself experiencing this degree of variation, you may be required to make the  $\pm 10\%$  selection to avoid the effect of electrostatic interference. The M4000 uses Line Frequency Modulation to measure above and below power line frequency to avoid measurement of electrostatic interference.

**M4000 Data Directory** - This is the directory in which the Clipboard data is to be stored. To change the default settings, use the mouse to click into the M4000 Data Directory field. Then, edit the settings to reflect in which directory the Clipboard data is stored.

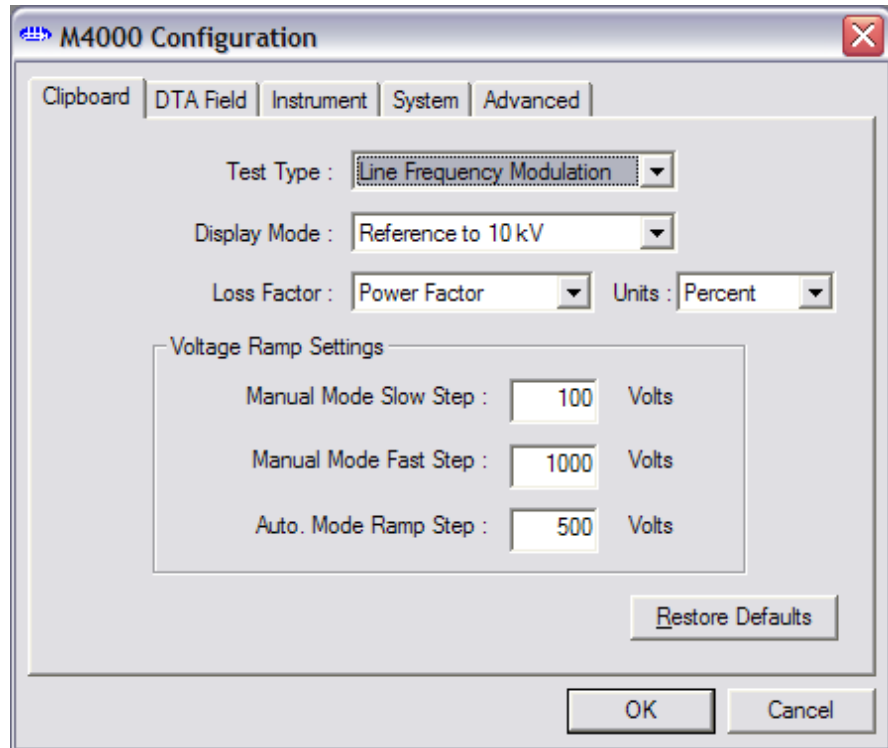
Select a directory other than C:\DOBLE\DTA for data storage for both Clipboard data and DTA data.\* Click on the OK button to accept your changes.

\* For example, use C:\Doble\DTA\DATA.

**Company:** If filled in, this line will cause all tests to use the information in the "Company" field when starting a new clipboard test.

## Clipboard Configuration

When selecting the Clipboard tab, the following appears:



*Figure 2.7 Clipboard Configuration*

**Test Type** - If Line Frequency Modulation is selected, a test at  $\pm 5\%$  of the reference frequency, will be performed. This selection is desirable when testing in the presence of electrostatic interference. If Line Sync Reversal is selected, a test at the positive polarity and a test at the negative polarity in reference to the input voltage at the base frequency is performed. This selection is desirable when performing tests using a resonator or exciting current tests on a transformer.

**Display Mode** - If Reference to 10 kV is selected, all results will be reported as if 10 kV were the applied voltage. If results obtained were tested at 2 kV, current and watts measurements will be multiplied by 5. Historically, this is the way all Doble tests have been performed. If Actual Values are selected, all results will be reported in reference to the applied voltage.

**Loss Factor** - There are two options available, Power Factor and Dissipation Factor, practically identical in routine usage. Dissipation Factor may be chosen when the user wishes to duplicate nameplate data from international manufacturers. However, the two are virtually identical at Power Factor readings below 5%. Units may be selected as *Percent* or *Actual* (and, for Dissipation Factor, mW/VAr). Power Factor is generally expressed in percent, and Dissipation Factor as Actual.

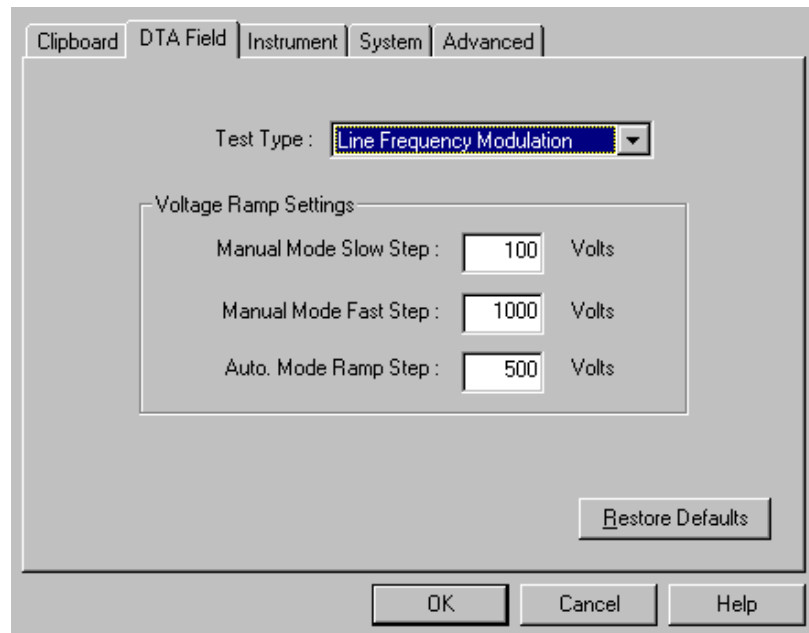
**Voltage Ramp Settings** - The rate of voltage change corresponding to the Auto Ramp Mode and Manual Set Options is entered in these fields. For example, the default settings call for an increase of 100 volts every time the up arrow is pressed when manually bringing up the voltage.

- **Manual Mode Slow Step** - The increment of voltage corresponding to each press of the up and down arrow key for manually setting the voltage. To change the default settings, click the mouse in this field and enter the desired voltage.
- **Manual Mode Fast Step** - The increment of voltage corresponding to each press of the PGUP and PgDn key for manually setting the voltage. To change the default settings, click the mouse in this field and enter the desired voltage.
- **Auto Mode Ramp Step** - The increment of voltage corresponding to the automatic voltage ramping steps. Using the default setting means that the voltage is raised and lowered in 500 volt increments. In the Auto Ramp Mode, voltage is lowered when a reversal is performed.

Click on the OK button to accept the selections.

## DTA Field Configuration

This only applies to users of DTA Field System Software. When the DTA Field Configuration tab is selected, the following appears:



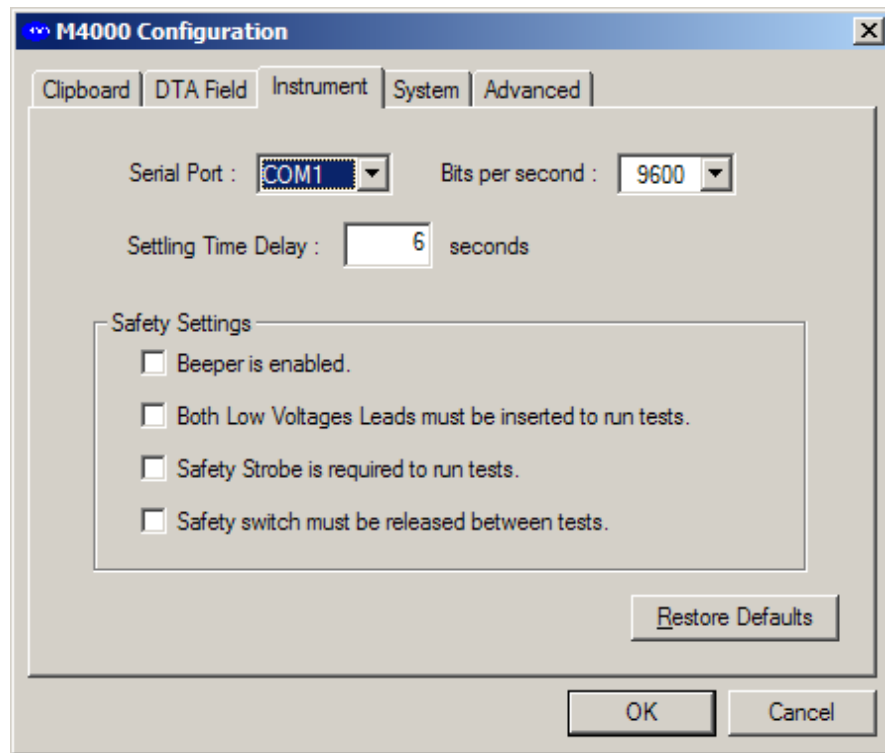
*Figure 2.8 DTA Configuration*

**Test Type** - See Clipboard Configuration for a description of this item.

**Voltage Ramp Settings** - See Clipboard Configuration for a description of this item.

## Instrument Configuration

When the Instrument Configuration tab is selected, the following appears:



*Figure 2.9 Instrument Configuration*

**Serial Port** - It may be necessary to change this setting to accommodate laptops being used with the M4100. The M4200c uses COM2, and laptops usually use COM1. The “bits per second” setting should not be changed from the default 9600.

**USB Converter**- If using a Serial to USB converter to utilize a USB port on your laptop for connection to the M4100, check your PC settings to obtain the comport that has been set by the converter. For Windows XP, go to the *Start* button, select *Control Panel/System* (or alternately, right-click *My Computer* and select *Properties*), then click *Hardware* and then *Device Manager*. Click the plus sign next to *Ports (Com & LPT)* to see the comport assigned to your converter.



**Settling Time Delay-** The time, at maximum test voltage, during which the M4000 samples the data. If it appears that excessive electrostatic interference is affecting test results, the settling time may be increased in order to sample the data over a longer period of time. To change the value in this field, click the mouse in this field and enter in a new value.

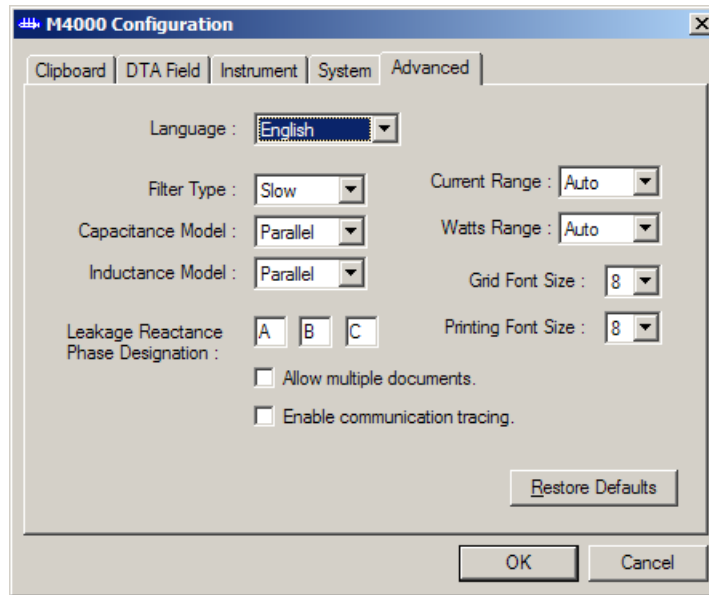
**Safety Settings** - These may be set as desired, provided the option “**Restrict the Safety Configuration settings**” was not set during software installation. If it was, and you want to change these settings, you will have to re-install the software and de-select that option. It is recommended that unless they are not functioning, the user should leave the beeper and strobe light operational. The settings are:

- **Beeper** - If the beeper is enabled, four beeps will sound when voltage is applied to a specimen. If the beeper is disabled, there will be no audible warning of applied voltage.
- **Both Low Voltage Leads must be inserted to run test** - it is recommended this box be left unchecked, since most tests require only one lead.
- **Safety Strobe required to run test-** If “required to run a test” is selected, the strobe must be plugged in or a test cannot run. If the strobe is not available, select “not required”.
- **Safety switch must be released between tests** - Prevents users from defeating the purpose of the safety switch by artificially holding it shut. The switches should be pressed when the message onscreen tells you to.

Click on the OK button to accept your selection.

## Advanced Configuration

When the Advanced tab is selected, the following is displayed:



*Figure 2.10 Advanced Configuration*

**Language:** Choose from English, French, Spanish, and Portuguese, if selected for installation.

**Filter Type:** The default is Slow, and should not be changed without consulting Doble.

**Capacitor Model:** The default is Parallel, and should not be changed without consulting Doble.

**Inductor Model:** The default is Parallel, and should not be changed without consulting Doble.

**Allow Multiple Documents:** If this box is checked, more than one set of test data can be active and displayed at once.

**Current Range:** The default is Auto, and should not be changed without consulting Doble.

**Watts Range:** The default is Auto, and should not be changed without consulting Doble.

**Grid Font Size:** Allows you to increase the size of the fonts on your screen, making it easier to see the data.

**Print Font Size:** Increases the size of the font used in printing.

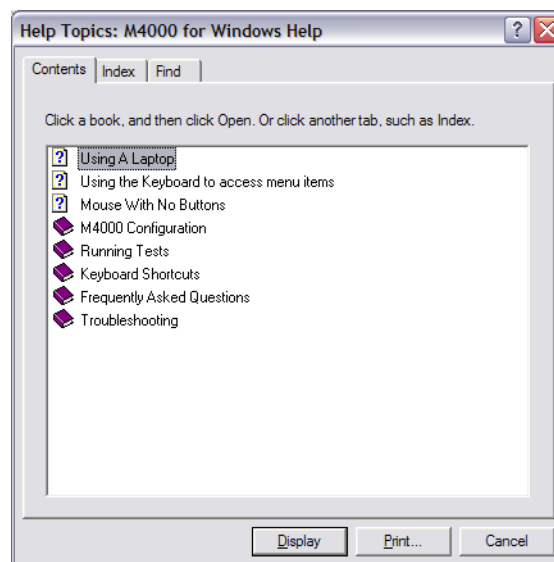
## Using Help

When Help is selected, two options are presented:

1. Contents F1.
2. About M4000 For Windows...

## Contents

The Help/Contents option opens the Help window:



*Figure 2.11 Help Window*

When **Contents** is selected, you can find how to use Help by pressing F1. The contents screen also has a series of buttons along its top:

The Glossary button has topics that are specific (such as, Auto Mode Ramp Step).

If you are unsure which item to select, you can use the Search function located on the top of the Help screen to find a specific topic.

To return to the previous screen, press Back located on the top of the Help screen.

To view each item in the list of contents, press the >> button. To go back to the Help of the previous item, press << button.

## About M4000 For Windows

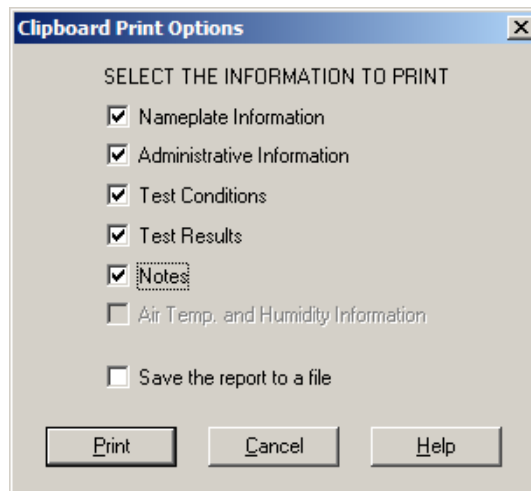
Selecting this item displays the current version of M4000 Software and firmware.

## Printer Setup

The default printer setting for your M4200c Controller is for a thermal printer. This enables the use of the M4200c Controller's built-in printer. If using a laptop, you must use Windows to add in the necessary printer drivers for your office printers.

## Printing

To print a Clipboard form, select Print from the file pull-down menu item, or press F7. The following screen will appear:



*Figure 2.12 Clipboard Form Report Generator*

To print a field, select it by clicking on the square, adding a checkmark. To print to a file, select "Save the report to a file" by clicking its box, adding a checkmark. Results can be saved in text (txt) or comma separated variable (csv) format.

A detailed description of each of these fields can be found in "Entering Clipboard Information" on page 3-1.

## 3. Running M4000 Tests

There are four test modes available with the M4000 software; all but Clipboard require optional software:

- Clipboard Mode

This is a generic form for recording and storing test results, nameplate information, weather conditions, test parameters, and notes, and is described below. A new graphing function allows test results to be graphed.

- External Reference/Source Mode (page 3-12)

This test mode enables the user to perform tests using an external source and reference, extending the range of test voltage above the 12 kV of the M4000 test set.

- Leakage Reactance Mode (page 3-16)

This test mode enables the user to measure transformer leakage reactance. Auxiliary hardware is required in the form of the M4110 Leakage Reactance Interface, or the M4130 Leakage Reactance Module.

- DTA Mode (page 3-17)

### Entering Clipboard Information

#### Nameplate Information

Within the Clipboard form, the following is what is considered nameplate information:

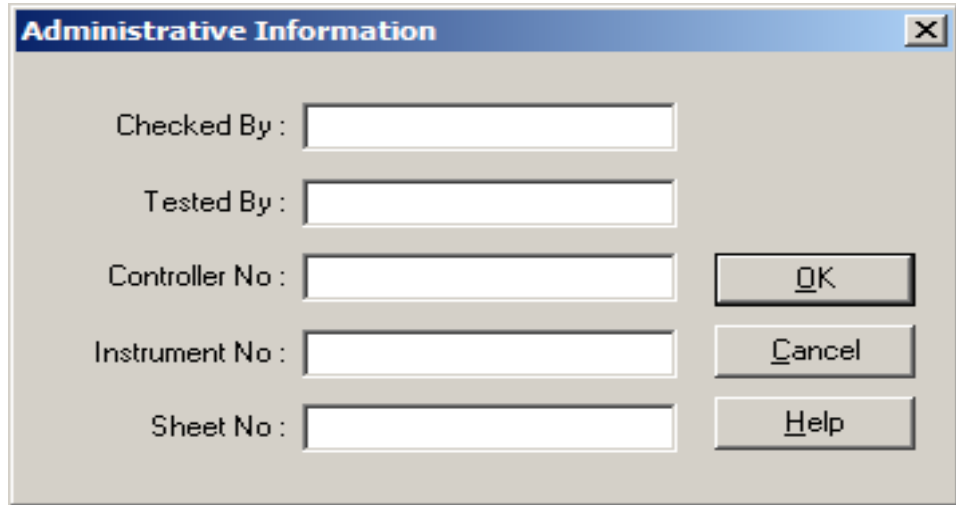
Company :	<input type="text"/>		
Location :	<input type="text"/>		
Equipment :	<input type="text"/>		
Serial Number :	<input type="text"/>	Manufacturer :	<input type="text"/>
Special ID :	<input type="text"/>	Circuit Designation :	<input type="text"/>

*Figure 3.1 Nameplate Information*

Entering this information is vital to properly identify the test and the equipment tested.

### Administrative Information

Next to the Nameplate Section is an Administration button. When clicking this button, the following screen will appear:



*Figure 3.2 Administrative Information*

The following is an identification of these terms:

- Checked By**            The person who checked the results (if different from the user).
- Tested By**            The user of the M4000 Insulation Analyzer.
- Controller No.**        The serial number is located on the bottom of the M4200c Controller.
- Instrument No.**        The serial number is located on the front panel of the M4100 Instrument.
- Sheet No.**            Identification for each single Clipboard Form is done with filenames when saving the form. Sheet number was a form of identification used on older paper test forms and the space is provided if the user needs to use it to further identify the test.


After entering this information, click on the OK button to save it.

## Test Conditions

Clicking on this button will show the following screen:

The screenshot shows a dialog box titled "Test Conditions". It features a "Weather" dropdown menu at the top. Below it are three rows of input fields: "Air Temperature" with a "°C" unit and a "Convert" button, "Oil Temperature" with a "°C" unit and a "Convert" button, and "Humidity" with a "%" unit. At the bottom of the dialog are three buttons: "OK", "Cancel", and "Help".

*Figure 3.3 Test Conditions*

The Weather is a pull down menu item with the selections accessed by clicking on the  (down arrow icon).


Entering Air Temperature and Humidity is unnecessary if using the Temperature Probe. If not, it is necessary to enter data in each field. In either case, Oil Temperature is required if testing oil-filled equipment. For transformers, use the top oil temperature.

Click on a Convert button first to enter the temperature in Fahrenheit.

Clicking the OK button will save the entries.



In the Clipboard mode, each row of test data contains the **Test Conditions** information. Test conditions for all the tests on the clipboard form can be seen



by clicking the  icon, or selecting **Tools/Temp. and Humidity**. The data found on the **Test Conditions** screen is that of the last test run.

## Test Results Information

Each line of the Clipboard test results contain the following fields:

Column	Description
No name...	Number – indicates the test line (row) number. There are 36 rows, accessible by scrolling down with the down arrow key.
TEST ID	Test Identification – on each test line, you can enter a serial number or description of the test to be performed.
LC	Line Configuration – To get an explanation of the letter displayed in this column, click the “?” on the icon bar. Clicking on the  will display the pop-up list of choices.
Circuit Desc.	Circuit Description – the abbreviation in this column defines the test circuit used when performing a test on a line of the Clipboard Form. Clicking on the  will display a pop-up window of all the choices. Select the desired choice. See “Test Modes Of The M4000 Analyzer, in the <i>Doble Test Procedures</i> manual.
kV	Kilovolts – this column indicates the test voltage, in thousands of volts, to be used during the test (for example, 10.00 means 10,000 volts).
mA	Milliamperes – this column contains the specimen test current results in milliamps. You cannot enter or make changes in this column. The results are recorded after pressing F5 to accept results of a test.
Watts	Watts – this column contains the specimen watts loss test results in watts. You cannot enter or change results in this column. The results are recorded after pressing F5 to accept results of a test.
Meas%PF	Measured Percent Power Factor. This column contains the calculated percent power factor from the Milliamperes and watts loss results obtained from the test. You cannot enter or change results in this column.




Column	Description
Corr. Fact.	<p>Temperature Correction Factor. This column includes automatic application of temperature correction factors to the Clipboard Form. The default correction factor is 1.00.</p> <p>The Measured Percent Power Factor is multiplied by this Temperature Correction Factor to obtain the Corrected Percent Power Factor in the column to the right of the Corr. Fact. Column. See "Temperature Correction" on page 2-12 for this automatic function.</p>
Corr%PF	Corrected Percent Power Factor. In this column, you will find the results of the Measured Percent Power Factor Times the Correction Factor. You cannot enter or change results in this column.
Cap. /Ind.	Capacitance/Inductance. Whether the current is capacitive or inductive is displayed in this column. You cannot enter or change results in this column.
RT	Rating. You may enter a one letter rating (G. B. I., etc.) of the insulation in this column.
N	<p>Note. If a note is entered for a single line, a check mark will show in this box. A test note is entered by selecting <i>Test Note...</i> from the <i>Tools</i> pull-down menu item, or by clicking on the notepad icon. You will be asked to which test line the note corresponds. The default test line is No. 1.</p> <p>To enter a note that relates to the entire Clipboard Form, type in the area at the bottom of the screen titled, <i>Sheet Note</i> (If it is hidden, click <i>Sheet Note</i> from the <i>View</i> menu).</p> <p>To clear a note, select <i>Clear</i> from the <i>Tools</i> pull-down menu item.</p>


## Running Single and Multiple Clipboard Tests

Either single or multiple tests (up to six at once) may be run. Each row or line of the test form represents one test, and for each test, the following information should be entered into the appropriate columns:

- Test ID
- Line Configuration (LC); the default value: A, Reference to 10 kV, Line Frequency Modulation, 60 Hz, is the most common (use B for a 50 Hz test). Use C, Reference to 10 kV, Line Sync Reversal, for testing with a resonator or for excitation current tests, regardless of system frequency.
- Circuit Description (GST-Ground, GST-Guard, UST)
- Test kV

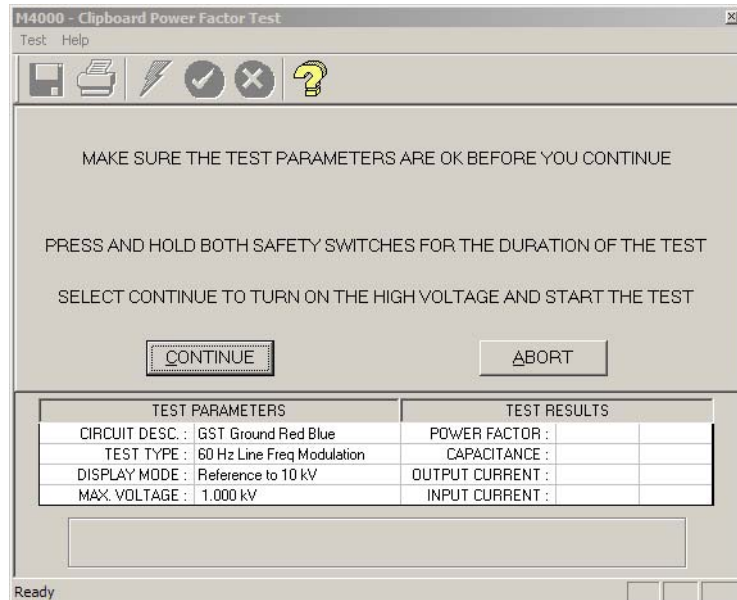
The above information may be entered before initiating a test. Or, a test may be initiated immediately, and you will be prompted to enter the line number, Line Configuration, Circuit Description and Test kV.

To run a single test, press F2, or click the  icon.

To run multiple tests (up to six), press FN+F11 or click the  icon.

## Raising Test Voltage

After making the necessary entries, the following screen appears:



*Figure 3.4 Safety Screen*

This screen shows the parameters that will be used when the test is run. Double-check the cable connections and test parameters. If the test parameters are not correct, click on the Abort button or press the ESC key.

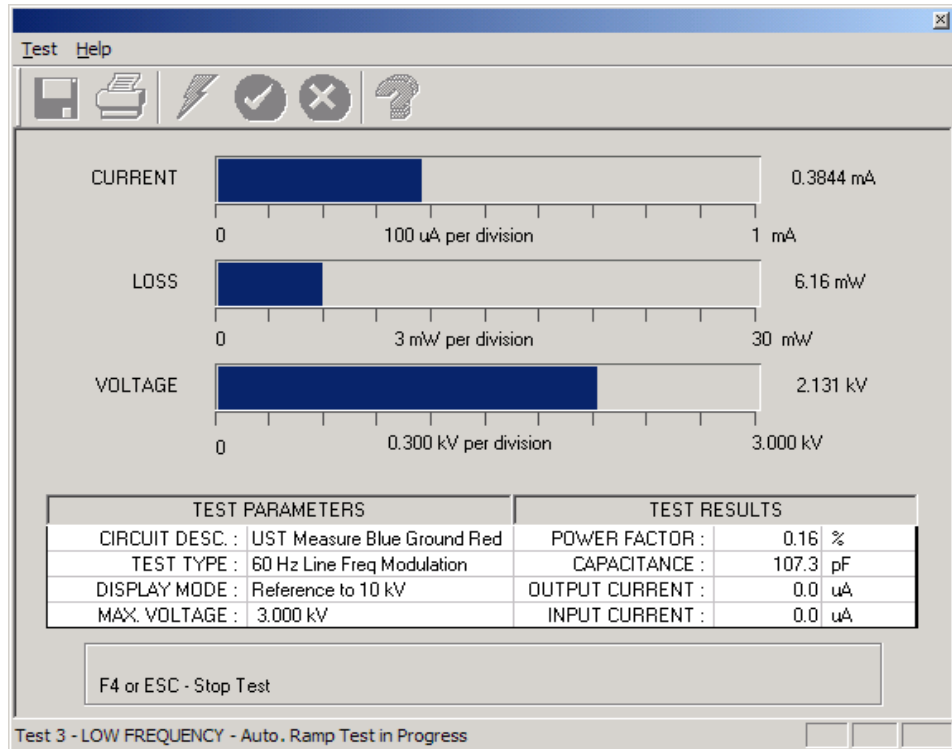
When the parameters are correct, proceed with the test by depressing both safety push buttons, and either pressing the ENTER key or clicking on the Continue button.

### WARNING



**High voltage will be present after starting the test. Pressing the ESC key or F4, or releasing a safety push-button, will turn off the high voltage.**

The following screen will appear:

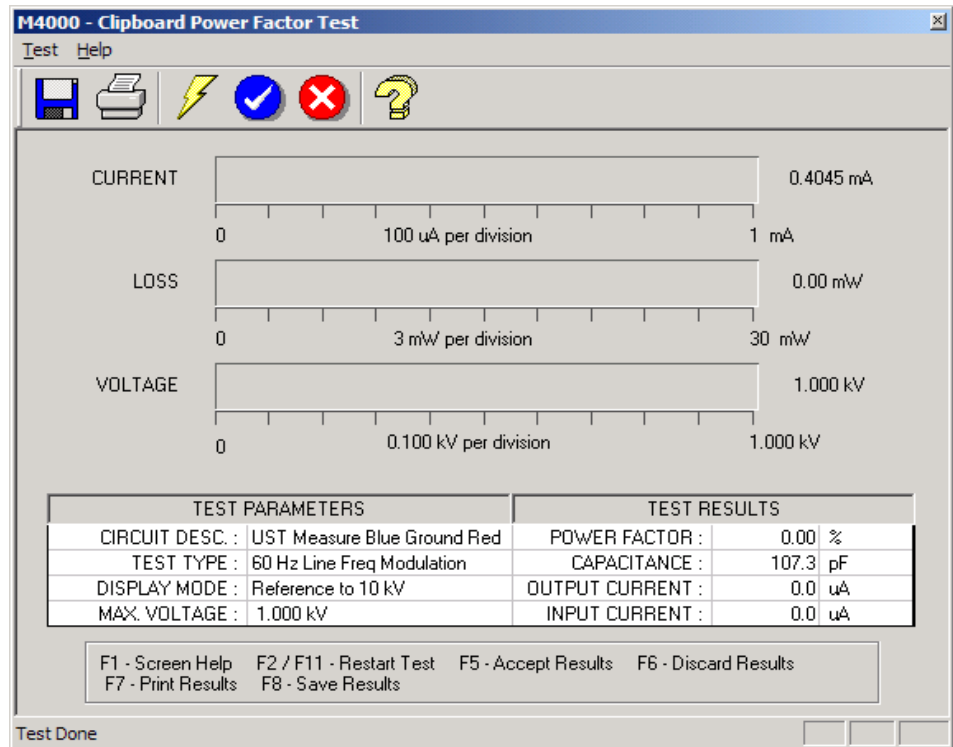


**Figure 3.5 Test in Progress**

The test will proceed automatically if Auto Ramp Mode is selected in the Clipboard Configuration, or will be ramped up by the operator if Manual Set Voltage is selected in the Clipboard Configuration. The digital values for these parameters will be shown to the right of the meters. The table on the screen describes test conditions and power factor test results. The line on the bottom of the screen displays the status of the test. When running multiple Clipboard tests, the line number of the test that is running will be displayed on the same line. For each test line, the voltage will ramp to the required maximum test voltage twice. This is required to implement the selected electrostatic interference cancellation technique (Line Synchronized Reversal or Line Frequency Modulation).

## Test Results

After the test is completed, the following appears:



*Figure 3.6 Test Complete*

There are choices listed at the bottom of the screen. An explanation of each key's function is as follows:

**Icon Description**



Pressing F1 will display “Screen Help” which is also available by clicking on this icon.



Pressing F2 or FN+F11 will “Restart Test”, also available by clicking on this icon.



Pressing F5 will “Accept Results” of the test(s) successfully performed, return to the Clipboard Form, and copy the results into the proper columns. When performing multiple tests, only tests completed prior to a stopped test will be accepted into the Clipboard Form. This is also available by clicking on this icon.

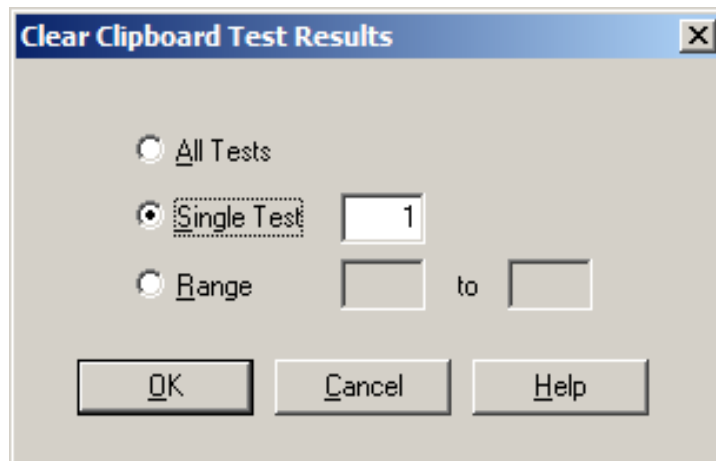
**Icon**    **Description**



Pressing F6 will “Discard Results” and returns you to the Clipboard Form. This is also available by clicking on this icon.

## Clearing Test Results

After acceptance of tests, you can clear the test results by selecting *Clear/Test Results* from the *Tools* pull-down menu item, or, by pressing F10. When this is done, the following screen appears:




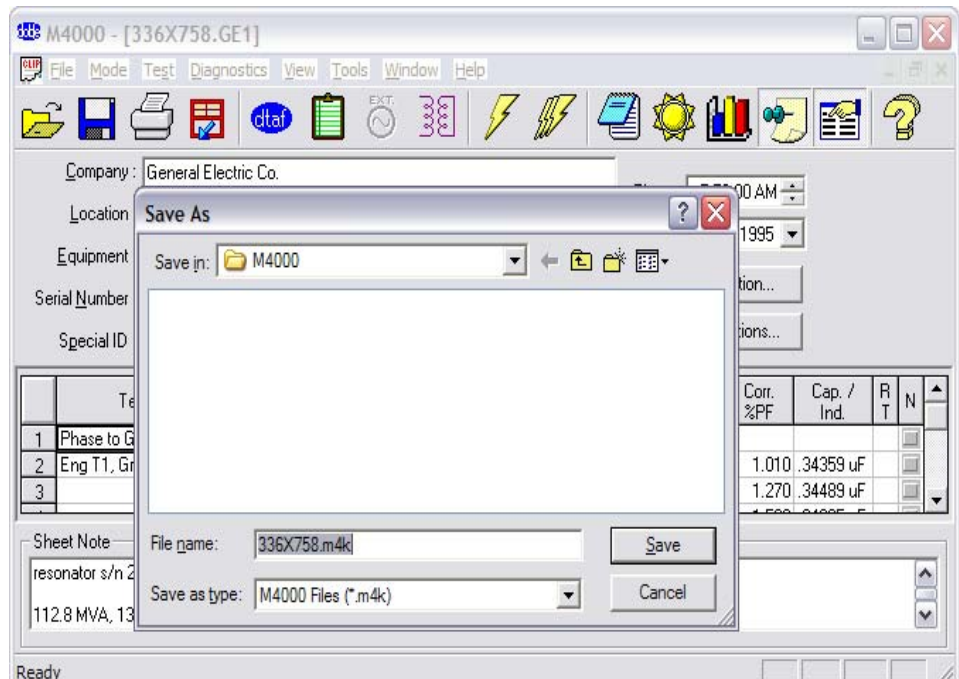
*Figure 3.7 Clear Test Results*

You have the option to clear all tests, clear a single test line, or clear multiple test lines.

## Saving Test Results



To save the nameplate and clipboard data, select the  icon, or the Save As... item under the File menu. You will be prompted to select a file name. You may save in the selected folder (typically C:\doble\dta\data).



*Figure 3.8 Saving Clipboard*

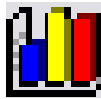
### NOTE

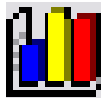
As you add tests in Clipboard, you may want to periodically save the file to include added test data. All 200 lines may be saved under a single file name. But after saving with a given file name the first time, all subsequent saves with the same name will result in the message, “This file already exists. Do you want to replace it?” Select the “Yes” button, or the new data will not be saved. However, if the Serial Number or Special ID fields have been edited since the last save, the filename, which is based on one of these two fields, will have changed and the file will be saved based on the new filename. Once all 36 lines are filled with data, save it one last time. Then, to continue, you must clear the data and start a new file name.

## Graphing Test Results

With the new graphing function, you can graph data on the clipboard sheet.

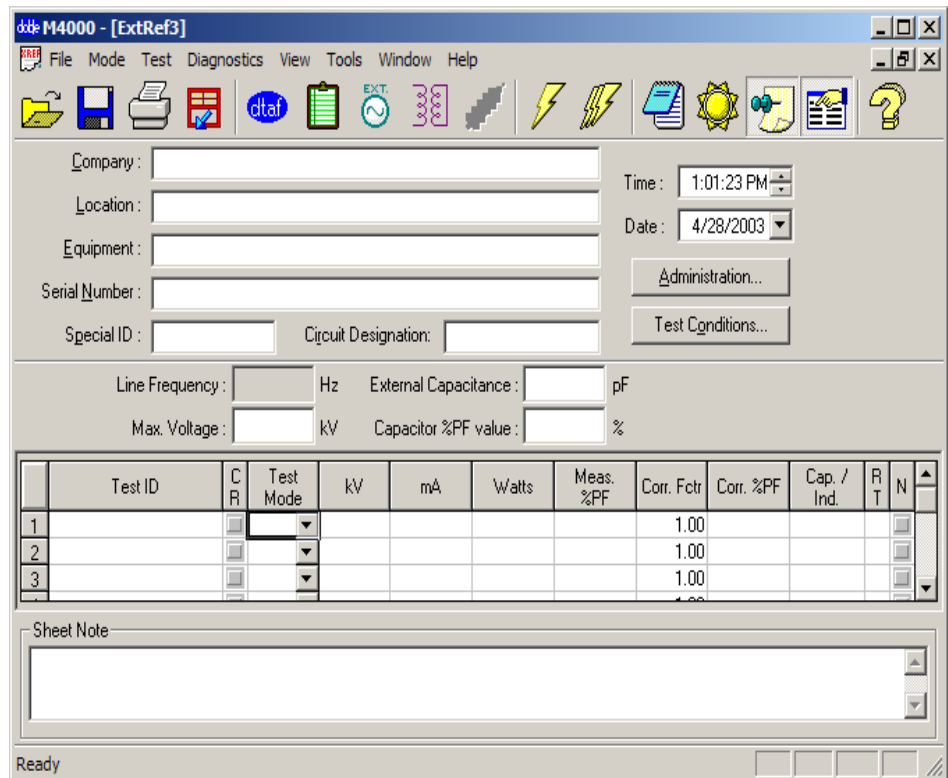
1. Run a test or open a file, placing data on the clipboard.
2. Select the test data you wish to be graphed.



3. Click the  icon. In the pop-up window, select whether you want a Histogram or a Trend.
4. If a Histogram is chosen, select the value you wish to plot. In Bins, select the number of ranges you wish to use to categorize your data, then click *Draw*.
5. If a Trend is chosen, select values to plot on the X and Y axes, then click *Draw*.
6. After you have drawn the graph, there are several icons along the top you can select to change the type of graph, or to refine it's appearance.

## External Reference/Source Test (Optional Software)

### Running A UST Test



*Figure 3.9 External Reference Main Screen*



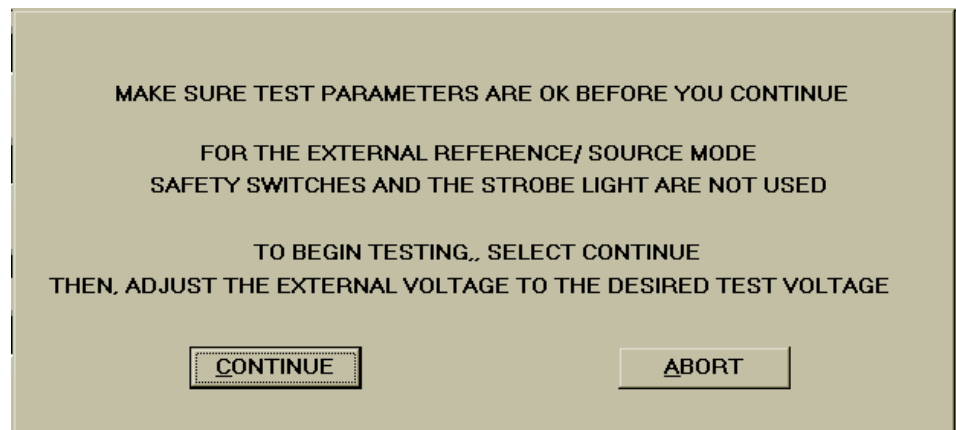
1. Select “External Reference” from “Mode” on the M4000 menu bar, or click the External Source icon.



2. There are two test types: UST Measure Blue and GST Guard Blue. Select UST Measure Blue from the Test Mode column.
3. There will be one clipboard sheet per test sequence with a maximum number of tests in a sequence of 12.
4. Before running a test, enter the capacitance and power factor of the reference capacitor, and the maximum test voltage.
5. Start a test by selecting *Test* from the menu bar, or by pressing F2, or by clicking one of the lightning bolt icons (single or multiple tests can be run). The line frequency will be measured and recorded.
6. You will be prompted to select a line number on which to place test results, and whether the test is a Normal or Reversal (the first test for a given line is by default a Normal test).
7. The safety screen is displayed with your selected settings. When you are ready to begin the test, select the Continue button.

**WARNING**

**Observe the warning noted in Figure 3.10.**



*Figure 3.10 Warning*

8. The M4000 is now ready to measure. The message “Set Test Voltage, Line (x), Then Press F3 To Measure”, appears (where (x) is the selected line number).
9. When you have set the external source to the desired voltage, press the F3 key. The message, “Do not change voltage - collecting data” appears.

10. When the message, “Test Done, Line (x)”, where (x) is the selected line number, press the F5 key to accept results. The mA, Watts, Percent Power Factor, and Capacitance/Inductance is recorded on the clipboard sheet.
11. At this point, a reversal could be run for this line (x). To do this, repeat steps 5 through 10, selecting the same line number, and selecting “Reversal”. Since performing reversals requires reversing the leads on the external source, it will be practical to perform a series of Normal tests first, and then go back, reverse the leads to the external source, and perform a series of Reversal tests corresponding to the Normal tests.
12. Once you have pressed F5 to save the reversal results, the line(s) that contain both Normal and Reversal data will be check-marked in the CR column. If you are testing indoors, it is unlikely you will need to perform Reversal Tests.

## Running a GST-Guard Test

1. Select “External Reference” from “Mode” on the M4000 menu bar, or click the External Source icon.
2. There are two test types: UST Measure Blue and GST Guard Blue. Select GST Guard Blue from the Test Mode column.
3. There will be one clipboard sheet per test sequence with a maximum number of tests in a sequence of 12.
4. Before running a test, enter the capacitance and power factor of the reference capacitor, and the maximum test voltage.
5. Start a test by selecting Test from the menu bar, or by pressing F2, or by clicking one of the lightning bolt icons (single or multiple tests can be run). The line frequency will be measured and recorded.
6. You will be prompted to select a line number on which to place test results, either a Specimen Test or Setup Correction Test (the first test for a given line is by default a Specimen Test), and either the Normal or Reversal mode (the first test for each line is by default a Normal mode test).
7. The safety screen is displayed with your selected settings. When you are ready to begin the test, select the Continue button.

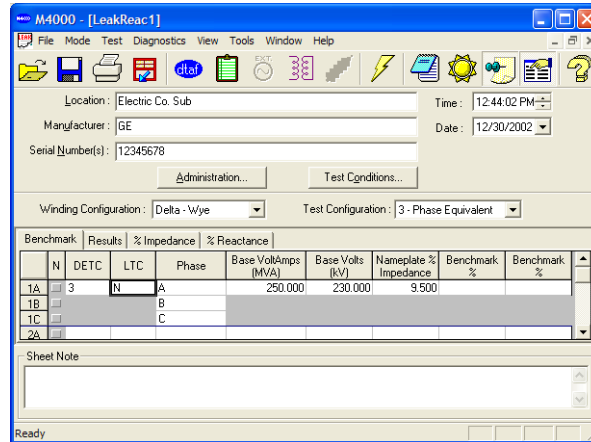
### WARNING




**For the External Source Test Mode, safety switches and the strobe light are not used. The External Source voltage is not controlled by the M4000. Proper safety precautions must be taken.**

8. The M4000 is now ready to measure. The message “Set Test Voltage, Line (x), Then Press F3 To Measure”, appears (where (x) is the selected line number).
9. When you have set the external source to the desired voltage, press the F3 key. The message, “Do not change voltage - collecting data” appears.
10. When the message, “Test Done, Line (x)”, where (x) is the selected line number, press the F5 key to accept results. The mA, Watts, Percent Power Factor, and Capacitance/Inductance is recorded on the clipboard sheet.
11. At this point, if your test was a Specimen Test, you could run the Setup Correction Test for this line (x). To do this, repeat steps 5 through 10, selecting the same line number, and selecting Setup Correction Test. Since performing the Setup Correction Test requires removing the high voltage cable from the specimen, it will be practical to perform a series of Specimen Tests first, and then go back, remove the high voltage cable from the specimen, and perform a series of Setup Correction Tests corresponding to the Specimen tests. If the losses of the High Voltage cable and transformer can be guarded, it is not necessary to perform the setup.
12. Once you have pressed F5 to save the Setup Correction Test results, the line(s) that contain both the Specimen Test and Setup Correction Test will be check-marked in the CR column.
13. You now have the option of repeating your tests in the reversal mode. Simply repeat steps 5-12, always selecting the Reversal mode instead of the Normal mode. When finished, you will have done either two tests per line (no reversal tests made) or four tests per line (including reversal tests). If testing indoors, Reversal Tests are not likely to be necessary.

## Leakage Reactance Test (Optional Software)



1. Click on the Leakage Reactance button  to display the Leakage Reactance test. Fill in *Location*, *Manufacturer*, and *Serial Number*.
2. Click the *Benchmark* tab and enter the nameplate data; this includes the transformer impedance, and the MVA, kV, and tap positions at which it was measured in the factory.
3. If this is not the first test, enter the benchmark values from the first test; if it is the first test, enter the transformer nameplate impedance in both the impedance and reactance benchmark fields.
4. Select the *Winding Configuration*, then the *Test Configuration*. If this is the first test, perform a 3 phase equivalent test for comparison to nameplate impedance, then three per phase tests (one per phase) to obtain benchmark values for each phase for comparison to future tests.
5. Use the *Phase* column to identify the winding measured.

6. Click the Run a Test icon  to start the test.

For complete details of this test, including test setup and connections, see “Leakage Reactance Testing” in the *Doble Test Procedures* manual.

**NOTE**  


**Always exit Windows before shutting off your M4000 Insulation Analyzer.**

## DTA Mode

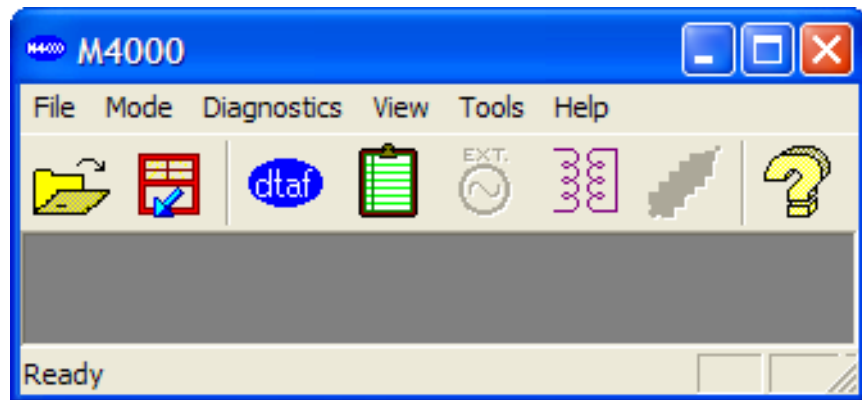
The remainder of this chapter describes how to run tests in the Doble Test Assistant (DTA) Mode. For a complete description of the DTA program, refer to the DTA Field System for Windows Users Guide. It is recommended that this manual be available for reference.

**NOTE**  


**The DTA Mode is not available unless the DTA software has been purchased and has been loaded onto the M4000. If you are not using DTA, all testing with the M4000 will be done in the “Clipboard” mode, as described earlier.**


## DTA Tests

With no test type selected, the main M4000 screen appears as follows:



*Figure 3.11 M4000 Main Window*

To test in the DTA Mode:

- Click on the  icon,  
or
- Select the “Mode” item on the menu bar using the mouse, or by pressing **ALT+M**. Then select DTA option.

Either the icon or the menu method will bring you to the DTA Data Manager, seen in Figure 3.12.

## DTA Data Manager

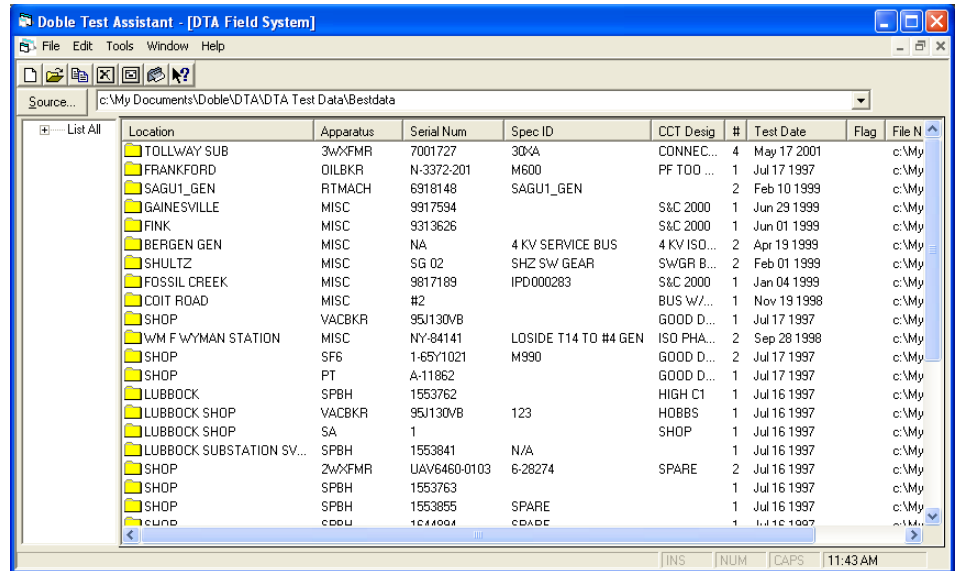


Figure 3.12 DTA Data Manager

If you are using the windows version of DTA for the first time, the working directory may appear as “C:\DOBLE\DTA\DATA”. If you have been using the DOS version of DTA, your working directory is “C\DTA\DATA”. If you wish to continue using the old directory, or wish to change the directory, proceed as follows:

1. Click the **Source** button under the icons at the top of the screen.
2. From the pop-up window, select the new directory.
3. If using DTA version 4.1, run the program, and from the main screen:
4. Select **Change** from the **Directory** menu.

5. In the resulting pop-up Source Directory window, type in the desired directory.
6. Click on “Dir List” if you want to browse through your computer files and locate another.

## Preparing for a DTA Test

### NOTE



The M4000 software version 3.xx requires DTA software version 5.xx.



1. Click the New icon if no previous tests for this apparatus are available in DTA. This will create a new test and a new apparatus record.
2. If a previous test exists in your DTA directory, select it from the existing apparatus tests in the right-hand column (if there is still no list, you may have the wrong directory). Double click the desired apparatus in the right-hand panel of DTA. To sort the displayed list, click on the column you wish to sort by.
3. See the DTA Users Guide on how to arrive at the ID panel of the new test form, if necessary.
4. If the open file contains previous test data, click the *Next Test Date* icon



. This creates a new, blank, set of test sheets.




5. Enter the atmospheric conditions by clicking the icon, or by selecting *Test Conditions* from the *View* menu.
6. After entering necessary nameplate data and other apparatus identification, proceed to the *Overall* test form.
7. Connect the test cables to the apparatus to be tested. See the DTA test form for help in making the connections for the tests listed, or see the *Doble Test Procedures* manual.

## Starting a DTA Test

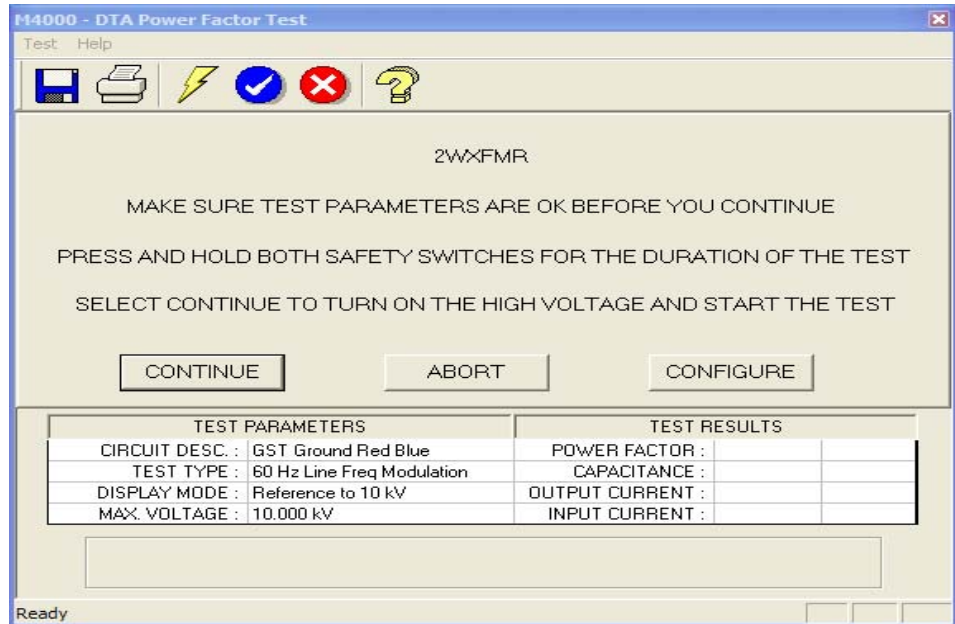
1. Move the cursor to the “Test kV” field for the test to be performed. Type in the required test voltage.



2. Start a test by clicking the  icon, or by selecting from the *Test* menu, *Run Test - M4000*. The “Test Conditions” window will appear if you haven’t yet filled it in, with “Prb” in the air temperature field. This indicates that air temperature will be entered automatically by the M4000 Temperature and Relative Humidity Sensor. If “Prb” doesn’t appear, then the temperature/humidity sensor is not connected or is not working. An oil temperature is required for oil-filled equipment. If the Temperature and Relative Humidity Sensor is not used, an air temperature is also required.
3. Click the OK button in the *Test Conditions* window.
4. A “Run M4000 Test” pop-up window will appear.
5. Choose to run a single or a multiple test. A single test is a test for the line the cursor is on. The multiple test will run all tests associated with one set of connections. Select the appropriate choice (see the DTA manual for details). You will most likely select *Multiple Tests - Default*.
6. In some types of apparatus, such as live-tank breakers or three-winding transformers, both red and blue leads are generally used. In such cases, DTA will ask you where each color lead was placed. You may select the *Setup* button in any case, to check the selected test voltage for each test you plan to do, as well as the default test circuit.

You will then be presented with a safety screen, where test circuit and voltage can be checked. This is your last chance to be sure these parameters are correct, and to abort the test if they are wrong.





*Figure 3.13 Safety Screen*

1. Select the “Abort” button to return to DTA and make changes. Make this choice if the test voltage needs to be changed.
2. Select the “Configure” button to change other test parameters, such as Frequency or Test Type.

**WARNING**

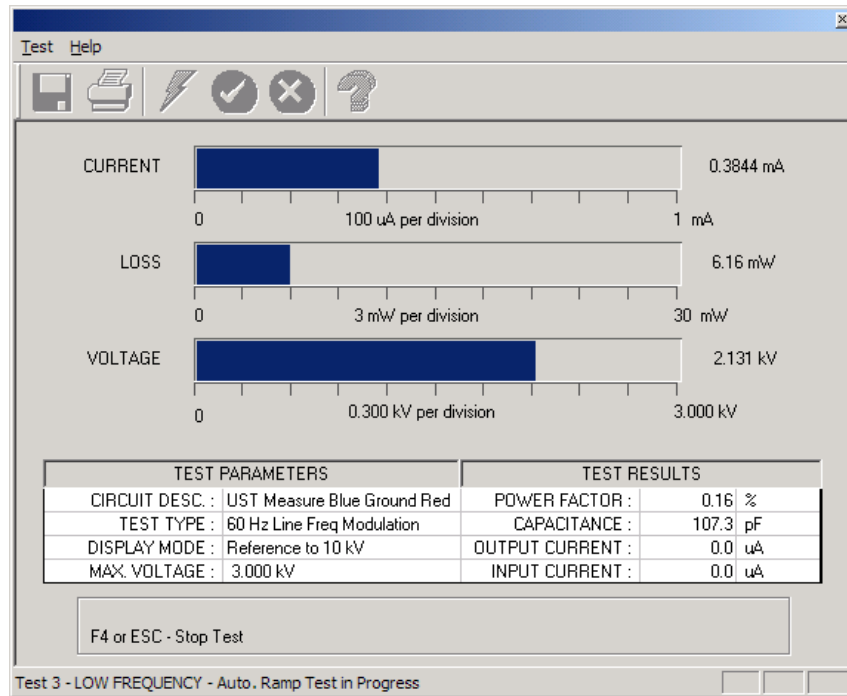


**High voltage will be present after starting the test. Pressing the ESC or F4 key, or releasing a safety switch button, will turn off the high voltage.**

When the parameters are correct, proceed with the test by:

3. Pressing both safety switch buttons.
4. Selecting the “Continue” button by highlighting it and pressing the ENTER key.

The following screen will appear:

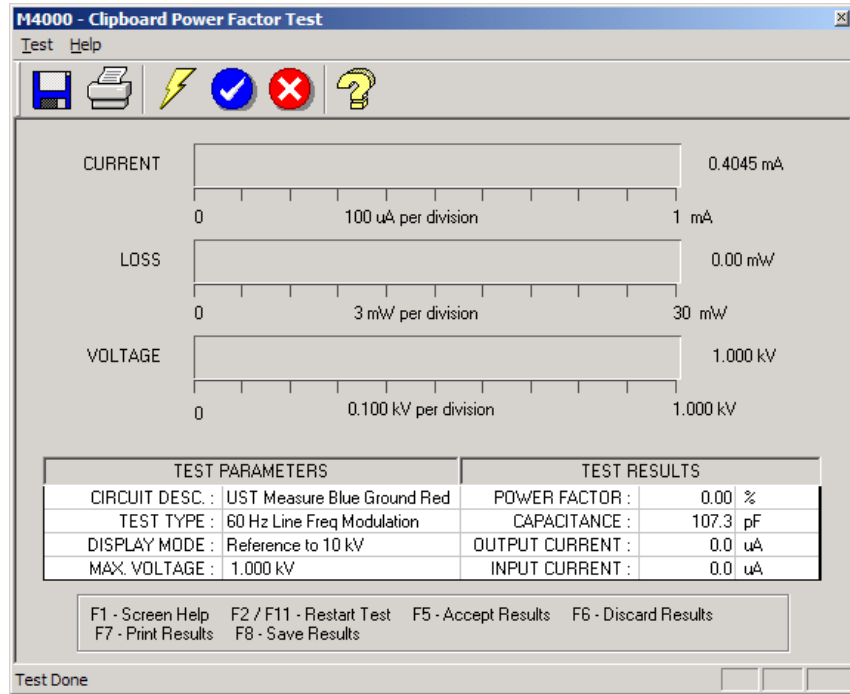


**Figure 3.14 DTA Test In Progress**

The test will proceed automatically. The test specimen’s current, watts loss, and voltage will be displayed in three analog meters (horizontal bars) on the screen. The digital values for these parameters will be shown to the right of the meters. The table on the screen describes test conditions and test results. The horizontal bar at the bottom of the screen displays the status of the test.

For each test being performed, the voltage will ramp to the preselected maximum twice. This is required to implement the selected interference cancellation technique (Line Synchronized Reversal or Line Frequency Modulation).





When the test is over, the status bar will read “Test Done”.



*Figure 3.15 End of DTA Test*

## DTA Icons and Function Keys

A list of function keys is displayed at the bottom of the screen after the test. In addition, a row of icons appears at the top of the screen. An explanation of each icon and key function follows:

Selecting this icon or function key...	Does this...
 icon or F1 key	Displays screen Help
 icon or F2 or F11 key	Restarts the test
 icon or F5 key	Accepts test results, returns to the DTA form, and copies the results into the proper locations. When performing multiple tests, only tests completed prior to a stopped test will be accepted into DTA
 icon or F6 key	Discards test results, returning to the DTA form

After pressing the F5 key to accept results, the test data and insulation rating should be reviewed for correctness. The operator can continue to the next test on the DTA form.

**NOTE**  

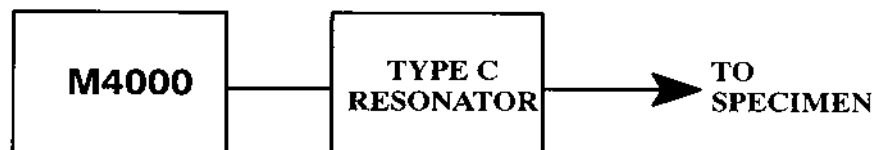

**Always exit Windows before shutting off your M4000 Insulation Analyzer.**

## Using A Resonator



*Figure 3.16 The Doble Resonator*

The Doble Type C Resonating Inductor is an iron-core reactor with an adjustable air gap, capable of resonating capacitances within a range of 0.05 to 1.0 microfarads at 60 Hz, and a range of 0.07-1.4 at 50 Hz. It is designed to extend the current range of Doble 10 kV Power-Factor Test Sets up to four Amps, assuming a lossless specimen, at voltages up to 10 kV. It extends the use of the set for testing relatively long cable lengths, large rotating machines, and other high-capacitance specimens. The ultimate range of the resonator depends not only on the capacitance of the specimen but also the total losses of the specimen under test.



*Figure 3.17 Power-Factor Test Set and Type C Resonating Inductor*

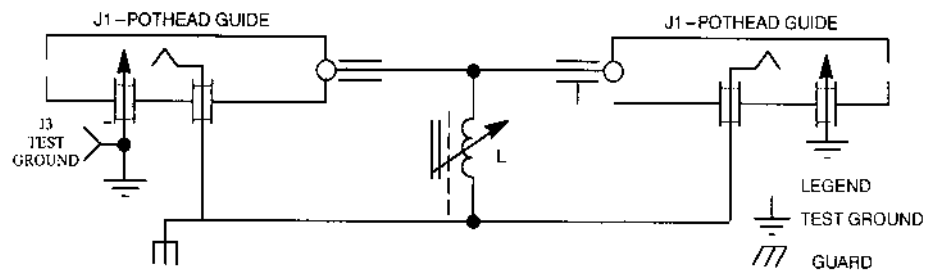
The Resonator, shown schematically in Figure 3.18, is contained in a metal housing measuring 24 x 17 x 15 inches, and weighs approximately 185 pounds.

**NOTE**  


**L adjustable from 7 to 140 Henries @60Hz.**

**Counter dial calibrated per calibration chart supplied with each unit.**

**Resonator chassis ground connected to test ground through cable shield or external test ground lead.**



*Figure 3.18 Schematic of Type C Resonating Inductor*

## Operating Procedure of Type C Resonating Inductor

The Resonator is connected to the M4100 Instrument by means of an 8-ft, 10 kV jumper cable. The regular 10 kV test cable is connected between the Resonator and the test specimen. Cable receptacles will be found in the rear of the Resonator case and can be used interchangeably (see Figure 3.18).

The Resonator is equipped with a core-clamping arrangement to reduce the noise level when the Resonator is in use, and more importantly, to minimize vibration. A speeder-type wrench is provided for use with this clamping arrangement and for use in tuning the Resonator. The clamping adjustment is located in the front vertical face of the Resonator while the tuning control is located in the top panel. Turning the clamping adjustment approximately 180° counterclockwise or clockwise will either unclamp or clamp the core, respectively.

If the equivalent 10 kV charging current of the test specimen is known, the Resonator may be set approximately by adjusting the tuning control until the counter setting corresponds to this current. Mounted on the Resonator panel is a reference chart relating the approximate counter reading to the specimen current.

Accurate tuning of the Resonator is obtained by turning the tuning control until the current taken from the 120 volt supply is a minimum. To do this in the Clipboard test mode, follow this procedure:

1. Set the test for Line Sync Reversal (Under the LC column, select C).
2. Connect the M4000, the resonator, and the specimen as shown in Figure 3.17
3. Select the “System” tab from the “Tools/Configuration” menu of the M4000.
4. Set the M4000 to the “Manual Set Voltage” Ramp Mode.

**NOTE**

**Do not raise the test voltage beyond the allowed limit for the attached specimen.**

5. Unclamp the Resonator Core.
6. Raise the test voltage to about 2 kV, using the Page Up (fast) or Up Arrow (slow) keys.
7. Observe the “input current” in the “Test Results” box.
8. Tune the Resonator until the “input current” of the M4000 is at a minimum.
9. To fine tune, raise the voltage to the final test voltage, or as close to it as possible, and repeat steps 7 and 8.
10. Reclamp the Resonator core.
11. Lower the voltage. The Resonator is tuned and you are ready to enter information on the row in the clipboard you are using for the test.
12. When filling in the clipboard row prior to starting the test, remember to select one of the “Line Sync Reversal” choices, C or F, in the LC (Line Configuration) column. For a description of all the Line Configuration choices, see “Glossary”, in the “Contents” selection of the M4000 “Help” menu.
13. When finished using the Resonator, you may wish to return to *Tools/Configuration* and return the M4000 to its original settings of “Auto. Ramp Voltage” Ramp Mode in the *System* Configuration.

Due to the high currents involved requiring the use of the Resonator, the 120 volt supply cord to the M4100 should be of relatively large wire gauge in order to minimize the line voltage drop.

## General Description of Type C-1 Coupler - RIV Test Procedure

**NOTE** Recommended for M2H only.



RIV (Radio-Influence Voltage) measurements may be of value in detecting corona on all types of insulation systems. One of the most common applications of RIV is with reference to rotating machinery insulation. The RIV Coupler in Figure 3.19 permits coupling of the radio-noise meter to the specimen with AC test voltage provided by the test set (refer to ANSI Guide C68.3- and IEEE Standard 454, “IEEE Recommended Practice for the Detection and Measurement of Partial Discharges (Corona) During Dielectric Tests”). The method usually employed detects partial discharges in the 1 MHz range. While some radio-noise meters use a diode-noise generator to produce reference signals, it is also feasible to use a radio receiver in conjunction with a standard signal generator. The signal generator should be capable of putting out a signal in the vicinity of 1 MHz, 50% modulated at 400 Hz, with a metered, adjustable output between 1 and 100,000 microvolts.

Figure 3.19 is a schematic of the Test Set complete with Resonator and coupling network (i.e., RIV Coupler) arranged for RIV (Radio-Influence Voltage) measurements. Note that the three components are arranged physically in series by means of two shielded jumper cables furnished with this equipment. One of the cables is connected between the M4100 Instrument and the Resonator. The second is connected between the Resonator and the RIV Coupler terminal marked “TRANSFORMER”. A standard 60-ft cable is used between the specimen and the RIV Coupler terminal marked “SPECIMEN.”

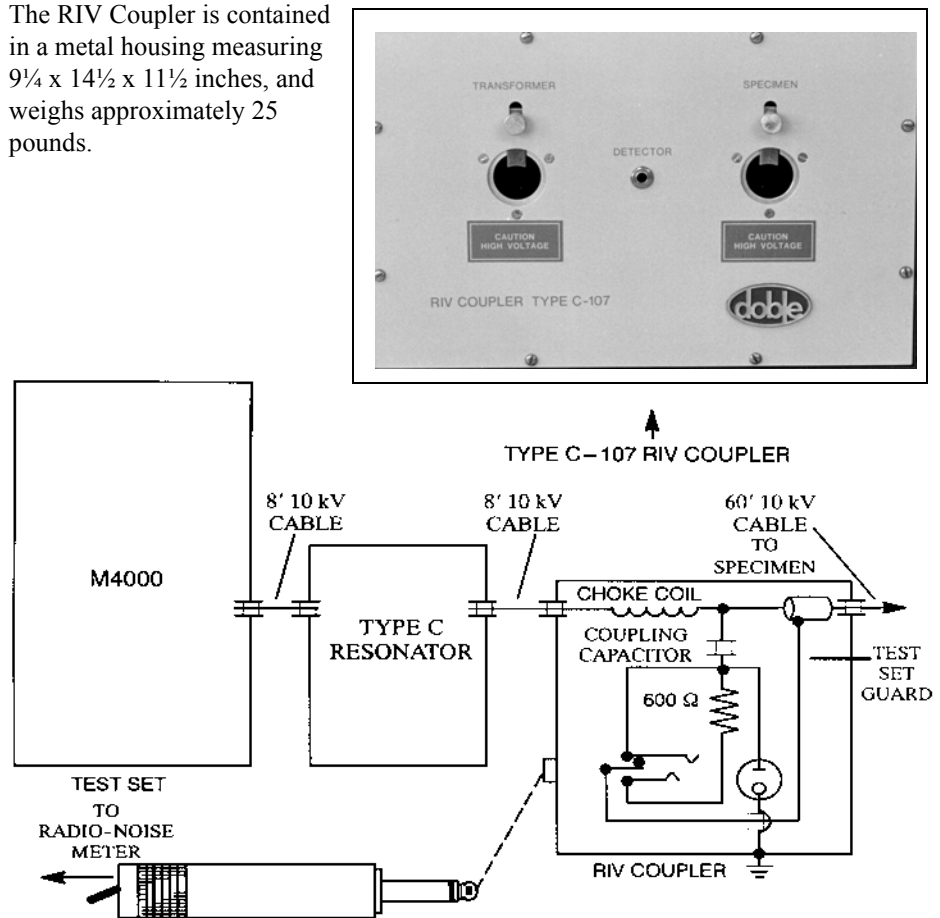
For low-capacitance specimens, when the Resonator is not used, connection is made directly from the M4100 Instrument to the RIV Coupler terminal marked “TRANSFORMER.”

Connection between the RIV Coupler and the radio-noise meter used for making RIV measurements is made by means of a single-circuit lead and telephone plug which plugs into the receptacle marked “DETECTOR” in the front of the Coupler. A separate common ground must be run from the M2H transformer case to the ground terminal of the radio-noise meter. To minimize shunting effects on the radio-noise meter, the capacitance between the RIV measuring lead and ground must be kept low. For this reason, use of a common two-conductor or shielded single-conductor lead is not recommended between the RIV Coupler and radio-noise meter.



Note that the circuit in Figure 3.19 is so arranged that, when the telephone plug is removed from the Coupler, the lower terminal of the coupling capacitor is connected to the test-set-guard circuit. In this way, the Coupler may be left connected for power-factor tests. The telephone plug must be removed or the capacitor current and losses will be included in the measurement. Note that if the telephone plug (i.e., the radio-noise meter) is left connected, the Coupler adds only a small watts loss to the measurement being made. Despite the shielding, some stray capacitive currents are measured. The stray currents (at 10 kV) may be measured with the Coupler connected for test but with no specimen connected. For low-capacitance specimens, this current may be subtracted before the power-factor calculation is made, if it is appreciable compared with the specimen current.

The RIV Coupler is contained in a metal housing measuring  $9\frac{1}{4} \times 14\frac{1}{2} \times 11\frac{1}{2}$  inches, and weighs approximately 25 pounds.



**Figure 3.19** Coupling Arrangement for RIV Measurements with 10 kV Test Sets

**NOTE**



**When the telephone plug is not connected to the Coupling Box, the lower terminal of the Coupling Capacitor is connected to the Test Set Guard Circuit. When the telephone plug is inserted into the receptacle, the Guard connection to the lower terminal of the Coupling Capacitor is removed and ground is applied to the low end of the 600 Ohm resistor via the barrel of the telephone plug.**

## 4. M4100 Instrument Troubleshooting

### Assigning A Trouble To The M4100 Instrument (Or The M4200c Controller)

This section is intended to guide the operator's initial steps in troubleshooting problems with the performance of the M4000 Insulation Analyzer. It outlines the resources available for diagnosis of problems and points to specific information in this chapter, or to the *M4200c Controller* manual. The overall purpose of this chapter is to support user personnel in diagnosing and fixing a majority of the difficulties that might be encountered in the field.

**NOTE**  
☞

**If it is clear that a problem is associated with the M4200c Controller, refer to the *M4200c Controller* manual. If it is clear that a problem is associated with the M4100 Instrument, continue through this chapter. If there is doubt as to the cause of a problem, proceed to the next page.**

**Doble's Customer Service staff is always available to support its customers if more guidance is required.**

### Quick Checks

Certain problems are very common and attributable to operator error or mishandling. Before investigating more complex causes of observed problems, run through the following list to determine if a simple oversight is the cause of trouble:

**Table 4.1 Quick Checks: Can You Answer Yes To These Items:**

<b>Item</b>
The communications cable is securely connected between the M4200c (or third-party controller) and the M4100.
Both the M4200c and M4100 are turned on and connected to an active, stable power source, appropriately rated and grounded.
Both safety switches were held closed <i>during</i> a specimen test and released <i>between</i> tests as required.
The test cables are securely connected to the specimen under test, and the specimen is ungrounded.
All the test leads are in good condition.
The printer is correctly loaded with paper of the proper kind.
Neither unit has been dropped recently or otherwise undergone rough treatment.
The floppy disk drive was empty during M4000 software boot-up.
The <b>Num Lock</b> and <b>Caps Lock</b> keys on the keyboard are switched off.

**NOTE**  
☛

**A majority of test set problems involve only the test leads, i.e. the High Voltage Test Cable and the Low Voltage Test Leads. Be especially alert to the condition of these items. They can be readily tested by following the procedures in "Running Other Tests" on page 4-42.**

## Troubleshooting Resources

The operator should consult this chapter first when a problem appears. It will help isolate the problem to the M4200c or the M4100 and will point to the most appropriate resources available to resolve the problem as quickly as possible. There are four categories of resources available, and these are summarized in Table 4.2.

**Table 4.2 M4000 Troubleshooting Resources**

<b>Resource</b>	<b>Description</b>	<b>M4100 Reference</b>
Symptoms	The most basic troubleshooting tool is the observation of a symptom of trouble by the M4000 operator. It is often the starting point for more detailed diagnostics.	page 4-12
Error Messages	The M4000 Insulation Analyzer automatically recognizes certain exception conditions and displays corresponding error messages to the operator. A Help button is also available in each displayed message box to provide guidance on suggested causes and cures.	page 4-16
Diagnostics	The M4000 supports automated self-diagnostic tests that are useful in validating system operation and troubleshooting problems that may occur. Diagnostics should be run on a regular basis to ensure that the M4000 Insulation Analyzer is functioning properly. The Diagnostics should also be used to investigate potential causes of error messages. Test results should be sent to Doble if Doble assistance is being requested.	page 4-21
Other Tests	Certain relatively simple external and internal tests can be performed to characterize a problem and point to a specific solution. In some cases these tests can avoid the need for component swapping as a diagnostic tool.	page 4-42 and page 4-50

## Isolating Trouble

The first step in pinpointing a problem is to determine whether the problem lies with the M4200c (or third-party controller) or the M4100. Consult Table 4.3 to determine which is the malfunctioning unit and what to do next.

**Table 4.3 Isolating the Problem**

<b>Observation</b>	<b>Suggested Action</b>
A <i>numbered</i> error message appears in the display.	The M4100 is likely to be at fault. See "Troubleshooting from Error Messages" on page 4-16. Also, click on <b>Help</b> for further guidance.
An <i>un-numbered</i> error message appears in the display.	The M4200c is likely to be at fault. See "Troubleshooting from Diagnostics" on page 4-21. Also, click on <b>Help</b> for further guidance.
The M4000 fails to complete the test of a specimen or yields unusual results.	The M4100 is likely to be at fault. See "Troubleshooting from Symptoms" on page 4-12.
The M4000 does not print as expected.	The problem lies with the M4200c. See the <i>M4200c Controller</i> manual.
A Diagnostics test has failed.	If the Communications Loopback Test has failed, the fault lies with the M4200c; see "Communications Loopback Test" on page 4-40. If any other Diagnostics test has failed, the M4100 is probably at fault; see "Running Other Tests" on page 4-42.
Either the display or keyboard is nonresponsive or responds in an unexpected manner.	The M4200c is at fault. See the <i>M4200c Controller</i> manual.
The M4000 software is either not working or acting erratically.	The fault probably lies with the M4200c. See the <i>M4200c Controller</i> manual.
Any other symptom, not described above, is evident.	See "Troubleshooting from Symptoms" on page 4-12.

## Avoiding Problems

The M4000 test set is rugged and can give many years of trouble-free service if it is handled with reasonable care. The following practices are suggested to minimize performance problems in the field.

### Precautions

It is recommended that the following precautions be followed:

- Keep the M4100 Instrument and Accessories clean and dry. Select a suitable storage location.

- Do not drop the instrument.
- Do not bend or coil the High Voltage Test Cable too tightly, no smaller than a 12-inch diameter coil.
- Do not use test leads for hoisting.
- Do not drag the High Voltage Test Cable or other leads across the ground, particularly if the ground surface is crushed stone.
- Do not yank at a Low Voltage Test Lead to disconnect its outboard clip, and do not yank any lead from its instrument connection.

## Preventive Maintenance

The following preventive maintenance actions are suggested:

- Periodically check all screw connections for tightness.
- Examine the High Voltage Test Cable periodically and check for corrosion, loose screws, gouges or cuts in the outer protective jacket, and for signs of tracking on the inboard and outboard potheads.
- Examine the inboard connectors of the various leads and accessories periodically.
- Periodically examine the connectors on the instrument case.
- Visually examine the safety switches periodically for worn connections.
- Periodically check that the HV Pothead receptacle on the instrument case is clean and dry.
- Periodically run the Calibration Verification Test (page 4-26) to check for proper system operation.

## Detailed Troubleshooting Of The M4100 Instrument

This section provides information that is useful in:

- Troubleshooting problems related to M4100 performance
- Performing specific external and internal checks to isolate the cause of M4100 malfunctions
- Accessing and replacing M4100 components which have failed
- Installing upgrades to certain M4100 components

### NOTE



**To address M4000 test set performance problems, it is important to follow the guidelines in the previous section before making the assumption that the M4100 is at fault.**

The major parts of this section and their purposes are summarized below:

<b>Section</b>	<b>Purpose</b>	<b>Page Reference</b>
Overview of M4100	Get introduced to the M4100 Instrument	page 4-7
Overview of Individual Replaceable Components	Identify all customer-replaceable components of the M4100	page 4-9
Troubleshooting from Symptoms	Obtain detailed guidance on troubleshooting, starting with observed symptoms of malfunction	page 4-12
Troubleshooting from Error Messages	Obtain detailed guidance on troubleshooting, starting with observed error messages	page 4-16
Troubleshooting from Diagnostics	Get help in running and interpreting the results of automated self-diagnostic tests	page 4-21
Running Other Tests	Identifying additional tests that can be run to troubleshoot problems without gaining access to internal components	page 4-42
Accessing M4100 Components	Learn how to remove the instrument's covers and identify its major components	page 4-46
M4100 Internal Checks	Learn about internal checks that can be performed to diagnose problems without replacing components	page 4-50
Replacing M4100 Components	Obtain detailed instructions on replacing components for the purpose of diagnosis or repair	page 4-56
	Replace:	
	Front Panel Assembly	page 4-58
	Guard Front Panel Board	page 4-61



<b>Section</b>	<b>Purpose</b>	<b>Page Reference</b>
	Amplifier Assembly	page 4-63
	Guard Mode Switch Board	page 4-66
	Timing Board	page 4-68
	DSP/CPU Board	page 4-70
	Safety Board	page 4-72
	Main Reference Assembly	page 4-74
	Guard Board	page 4-76
	Low Voltage Power Supply Board	page 4-78
	Heater/Temperature Controller Board	page 4-80
	Field Calibration Reference	page 4-82
	I/O Protection Board	page 4-83
	Transformer	page 4-85
	HV Pothead	page 4-91
	Fan Filter	page 4-93
	Fan	page 4-94

## Overview of M4100

The M4100 stimulates the insulation specimen under test with an AC voltage up to 12 kV in magnitude, an applied potential whose fundamental frequency is at or near the power system frequency. The instrument directly measures the specimen's current and voltage to derive all reported output parameters relating to insulation properties, including power loss, capacitance and power factor. The applied AC voltage is asynchronous with the power line frequency so that electrostatic interference can be filtered out. The M4100 contains digital control, power, analog measurement and safety circuits.

An overview of the M4100 and its major components gives a good starting point for gaining basic functional knowledge that is helpful in effective troubleshooting. A block diagram of the M4100, illustrating its major components, appears in Figure 4.1 on page 4-8.

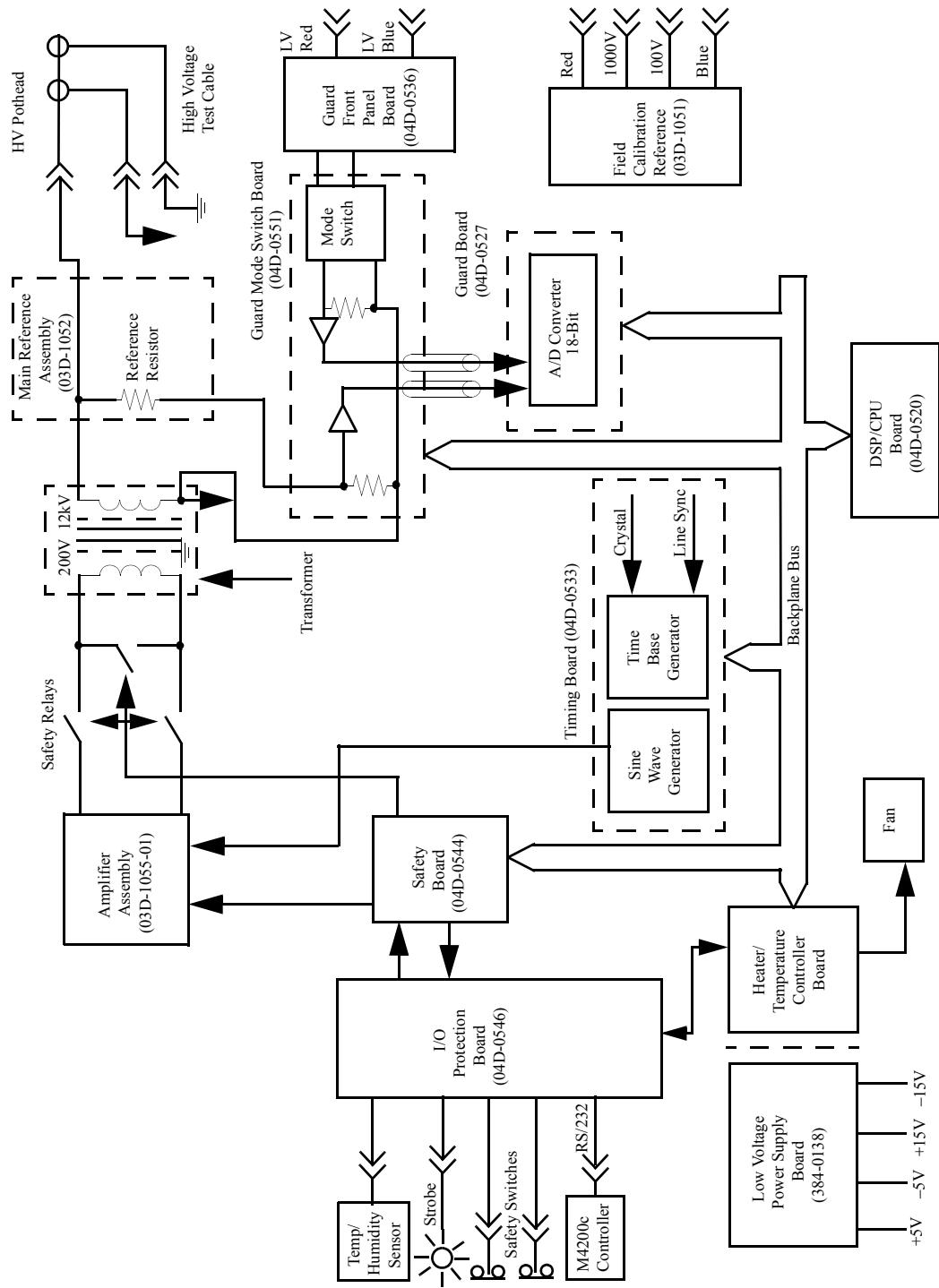


Figure 4.1 M4100 Block Diagram

## Overview of Individual Replaceable Components

An overview of each of the instrument's replaceable components is provided below. While a few other M4100 components exist, they are not field-replaceable.

Front Panel Assembly 03D-1056	The Front Panel Assembly includes all front panel-mounted components, including the Guard Front Panel Board and the I/O Protection Board.
Guard Front Panel Board 04D-0536	The Guard Front Panel Board provides interconnections for the low voltage test leads and the Guard Mode Switch Board.
Amplifier Assembly 03D-1055-01	The Amplifier Assembly converts the AC input signal – whether synchronous with the power system frequency or derived from a crystal oscillator – to AC test stimulus power. It drives a 10 kV step-up transformer through safety relay contacts.
Guard Mode Switch Board 04D-0551	The Guard Mode Switch Board consists of an array of semiconductor (FET) switches that routes the measured specimen and reference currents to the Guard Board, in accordance with the desired test mode.
Timing Board 04D-0533	The Timing Board serves two main purposes. First, it provides a high speed clock for A/D conversion. The clock is either synchronized to a selected test frequency, generally between 40 and 70 Hz, or synchronized to the line frequency. Second, this board provides a frequency counter used to measure the test frequency.
DSP/CPU Board 04D-0520	The DSP/CPU Board serves as the M4100 system controller and as a digital signal processor for high speed algorithmic processing of analog signals.

Safety Board 04D-0544	The Safety Board latches off the Amplifier Assembly and opens the safety relays when a potential operator safety hazard or hardware overload is detected. It also reports safety status and receives safety commands from the DSP/CPU Board.
Main Reference Assembly 04D-0583	The Main Reference Assembly stores calibration standard values used in comparing the measured specimen power factor and capacitance values.
Guard Board 04D-0527	The Guard Board provides signal conditioning of the specimen and reference currents for A/D conversion. Its functions include shunt selection, signal scaling, anti-alias filtering and A/D conversion. The optimum current range is selected automatically unless the operator manually specifies a range.
Low Voltage Power Supply Board 384-0138	The Low Voltage Power Supply Board supplies +5 VDC, -5 VDC, +15 VDC and -15 VDC for internal use throughout the M4100 Instrument.
Heater/Temperature Controller Board 04D-0547	The Heater/Temperature Controller Board senses the internal temperature and controls the fan.
Field Calibration Reference (Optional) 04D-0524	The Field Calibration Reference provides a means for checking calibration of the M4100 in the field using pre-calibrated, precision resistors. It can also be used as an external reference for other types of measurements, such as transformer short-circuit impedance tests and turns-ratio tests.

I/O Protection Board 04D-0546	The I/O Protection Board provides serial communications between the M4100 and M4200c and interfaces with the safety strobe light, temperature/humidity sensors and safety switch. It also provides certain safety features under hardware and software control.
Transformer 03D-1054	The Transformer steps up the voltage output of the Amplifier Assembly to a maximum of 12 kV for application to the specimen under test.
HV Pothead 03C-0056-07	The front panel-mounted HV Pothead is a connector providing a high-voltage connection to the specimen under test.
Fan 380-0042	The fan cools the interior of the M4100 by moving air through the instrument when necessary. It is normally <u>not</u> on.

## Troubleshooting from Symptoms


This section provides M4100 troubleshooting guidance based upon observed malfunction symptoms. Find the observed symptom in Table 4.4, and take the suggested action(s) to solve the problem.

**Table 4.4 M4100 Troubleshooting from Symptoms**

Symptom	Suggested Action
M4100 does not power up properly	<p data-bbox="873 632 1268 661">In a normal power-up sequence:</p> <ul data-bbox="922 674 1414 1003" style="list-style-type: none"> <li data-bbox="922 674 1414 741">• Front panel Power indicator comes on and stays on.</li> <li data-bbox="922 753 1414 919">• Front panel Processor indicator flashes about once per second until M4200c communications is established, then comes on and stays on.</li> <li data-bbox="922 932 1414 1003">• Front panel Heater indicator remains off.</li> </ul> <p data-bbox="873 1016 1175 1045">If power-up is abnormal:</p> <ol data-bbox="873 1058 1414 1386" style="list-style-type: none"> <li data-bbox="873 1058 1414 1136">1. Check F1, a 4-A fuse, as described in "LVPS Fuses" on page 4-52.</li> <li data-bbox="873 1148 1414 1262">2. Check fuses F1 and F2 on the Heater/Temperature Controller Board as shown in Figure 4.41 on page 4-80.</li> <li data-bbox="873 1274 1414 1386">3. Check the power supply voltages as described in "Low-Voltage Power Checkout" on page 4-51.</li> </ol>

**Table 4.4 M4100 Troubleshooting from Symptoms (Continued)**

Symptom	Suggested Action
Cannot begin a test; the test set trips, with an overcurrent error message	<ol style="list-style-type: none"> <li>1. Isolate the cause by restarting a test after alternately: <ul style="list-style-type: none"> <li>• Disconnecting the High Voltage Test Cable from the M4100</li> <li>• Disconnecting the High Voltage Test Cable from the specimen (but still connected to the M4100)</li> </ul> </li> </ol>

**DANGER**  **Avoid personal contact with the High Voltage Test Cable while it is connected to the M4100. Death or severe injury is an imminent risk.**

If the symptom disappears, test the cable by referring to "Checking the High Voltage Test Cable" on page 4-42. Replace the High Voltage Test Cable if necessary.

2. Check connections to the specimen.
3. The size of the specimen may be beyond the capacity of the test set, or the point to which the High Voltage Test Cable is connected may be grounded.
4. Check the HV Pothead for tracking, arcing, pothead separation and cleanliness. If it is faulty, replace it.

**Table 4.4 M4100 Troubleshooting from Symptoms (Continued)**

<b>Symptom</b>	<b>Suggested Action</b>
Instrument takes an unusually long time to make a measurement or never stops ranging	<ol style="list-style-type: none"> <li>1. Check and clean connections to the specimen. Use a clip lead between the High Voltage Test Cable and specimen to insure good contact.</li> <li>2. Check the High Voltage Test Cable by referring to "Checking the High Voltage Test Cable" on page 4-42. Then check the HV Pothead. If either component is faulty, replace it.</li> <li>3. Check for an unstable AC power source or a faulty power cable.</li> </ol>
Reported Current, Watts, and/or % Power Factor are zero	<ol style="list-style-type: none"> <li>1. Check cable and ground connections.</li> <li>2. Insignificant values (% Power Factor between 0 and -0.04%, Watts &lt; 10 <math>\mu</math>W, and Current &lt; 0.1 <math>\mu</math>A) are rounded to zero. These results can occur when measuring across a vacuum or SF6 interrupter, or when testing a good oil sample using the UST circuit.</li> </ol>
Tests made using GST circuits yield high, negative, or unstable readings	<ol style="list-style-type: none"> <li>1. Check for a guard-to-ground short as described in "Checking M4100 Guard-to-Ground Insulation" on page 4-43. If a short is detected, see "Guard-to-Ground Shorting Problems" on page 4-51.</li> <li>2. See "Orange Cable Checkout" on page 4-54.</li> </ol>



**Table 4.4 M4100 Troubleshooting from Symptoms (Continued)**

Symptom	Suggested Action
Negative watts obtained in UST or GST-Guard circuit	This may simply be due to surface dirt and moisture. Clean and dry the specimen's surface and retest it. This condition is most often found when testing bushing C <sub>1</sub> insulation, transformer Ch <sub>1</sub> insulation, or rotating machinery interwinding insulation. In the case of a bushing, the offending surface may be that on the lower part of the bushing inside its parent apparatus, or on the inside surface of the shell. See the paper in <i>1987 Doble Minutes</i> on negative watts, page 2-501.
Communications error message	<p>If any of a variety of communications-related error messages (see Appendix C) is displayed, take the following steps in sequence until the cause of the problem is identified:</p> <ol style="list-style-type: none"> <li data-bbox="922 1041 1409 1146">1. Run the Communications Loopback Test described in "Communications Loopback Test" on page 4-40.</li> <li data-bbox="922 1167 1458 1377">2. Check the communications cable (between the M4100 and M4200c) for bent connector pins and breaks or frayed areas in the cable jacket. Replace the cable if necessary (see item 5 of "Accessory Bag" on page A-2).</li> <li data-bbox="922 1398 1458 1587">3. Check the M4100 power supply voltages as described in "Low-Voltage Power Checkout" on page 4-51. Replace the Low Voltage Power Supply Board if necessary.</li> <li data-bbox="922 1608 1458 1743">4. If no other cause is determined, replace the I/O Protection Board in the M4100 (see "Replacing the I/O Protection Board" on page 4-83).</li> </ol>

## Troubleshooting from Error Messages

The M4000 Insulation Analyzer automatically recognizes certain exception conditions and displays corresponding error messages to the operator. Most error messages that pertain to the M4100 are numbered. These are described below.

**NOTE**  


**A complete list of all M4000 error messages appears in Appendix C.**

A few messages that point to very simple problems can be displayed, such as not having the M4100 turned on, not having it connected to the M4200c (or your laptop), or attempting to energize a specimen that is at ground potential. Other, less obvious messages are addressed below.

Error messages are listed in numerical order, followed by one or more suggested actions to take in response to the message. A Help button is also available in each displayed message box to provide guidance on suggested causes and cures.]

**Table 4.5 Error Messages**

#	Error Message	Suggested Action
20	Watchdog Reset Error	<ol style="list-style-type: none"> <li>1. After installing new software and when performing the first test thereafter, an interruption in firmware download may have occurred (i.e. the test set was turned off while the message, “Downloading Firmware” was displayed. See ”M4000 Software” on page 2-1).</li> <li>2. If performing an excitation current test, repeat the test at a lower voltage.</li> <li>3. If testing with a portable power supply, stabilize the supply by preloading it with a space heater or similar load.</li> <li>4. Reload the old version of software, then the new version again (see ”M4000 Software” on page 2-1).</li> </ol>
28	Earth Ground Open	<ol style="list-style-type: none"> <li>1. Connect the M4000 to ground.</li> <li>2. Connect the M4000 ground to the same ground as the system’s AC power source.</li> </ol>

**Table 4.5 Error Messages (Continued)**

#	Error Message	Suggested Action
33	One or both safety switch cables disconnected	<ol style="list-style-type: none"> <li>1. Clean all cable terminations.</li> <li>2. If the problem persists, replace the I/O Protection Board (see "Replacing the I/O Protection Board" on page 4-83)</li> </ol>
34		<ol style="list-style-type: none"> <li>1. Check the AC power source for abnormally low voltage.</li> <li>2. If this message was reported when running a specimen test, run "Subsystem Diagnostics" on page 4-34.</li> <li>3. If the problem is still unresolved, replace the Amplifier Assembly and rerun its diagnostic. Rerun the original specimen test at rated voltage (see "Replacing the Amplifier Assembly" on page 4-63).</li> </ol>
35	Overcurrent on Power Amp Output	<p>The instrument's output current limit has been exceeded.</p> <ol style="list-style-type: none"> <li>1. Repeat the test at a lower voltage.</li> <li>2. Check all test connections.</li> <li>3. Check for an inadvertently grounded specimen.</li> </ol>
36	Power Amp DC Supply High	Check the AC power source for abnormally high voltage.
37	Power Amp DC Supply Low	<ol style="list-style-type: none"> <li>1. Check the AC power source for abnormally low voltage.</li> <li>2. Try a heavier gauge or shorter AC line cord to the M4100.</li> <li>3. Replace the Amplifier Assembly (see "Replacing the Amplifier Assembly" on page 4-63).</li> </ol>

**Table 4.5 Error Messages (Continued)**

#	Error Message	Suggested Action
39	Phase Lock Loop Not Locked	<ol style="list-style-type: none"> <li>1. If a portable generator is being used to power the M4000, stabilize its output frequency by adding a load, such as a space heater, to load the generator.</li> <li>2. If the symptom occurs in line sync mode only, replace the Amplifier Assembly. If it occurs in both state modes, reseal the W8 cable connectors between the Guard Board and Guard Mode Switch Board (see Figure 4.26 on page 4-53). Replace the Guard Board and Guard Mode Switch Board, one at a time, if reseating the cable connectors does not help.</li> </ol>
41	Strobe Not Flashing	<p>Replace the strobe lamp. If the fixture needs replacing, temporarily operate the instrument without a strobe:</p> <ol style="list-style-type: none"> <li>1. Select <b>Instrument</b> from the <b>Tools/Configuration</b> menu in the M4000 software.</li> <li>2. Disable the strobe requirement.</li> </ol>
50	Lead Changed During Test	<ol style="list-style-type: none"> <li>1. Clean all cable terminations.</li> <li>2. If the problem persists, replace the Guard Front Panel Board (see "Replacing the Guard Front Panel Board" on page 4-61).</li> </ol>
51	Safety Switches Not Released Between Tests	<p>This is intended as a safety feature. When a test or a "multiple test" has been run, the safety switches must be released before starting the next test or "multiple test". Do not press the safety switches until the final pre-test warning screen is displayed. Otherwise the next test cannot be run.</p>

**Table 4.5 Error Messages (Continued)**

<b>#</b>	<b>Error Message</b>	<b>Suggested Action</b>
53	One or Both Low Voltage Leads Disconnected	<ol style="list-style-type: none"> <li>1. If this error is displayed during Calibration Verification, rerun the test at a temperature above freezing.</li> <li>2. Clean all cable terminations.</li> <li>3. If the problem persists, replace the Guard Front Panel Board (see "Replacing the Guard Front Panel Board" on page 4-61).</li> </ol>
54	Overcurrent Occurred	<p>Input current is excessive.</p> <ol style="list-style-type: none"> <li>1. Try a 240 V AC power source instead of a 120 V source.</li> <li>2. Check the HV Pothead guide for internal separation or tracking.</li> </ol>
56	Input Current Peak Maximum Exceeded	<p>Input current is excessive.</p> <ol style="list-style-type: none"> <li>1. Try a 240 V AC power source instead of a 120 V source.</li> <li>2. Check the HV Pothead guide for internal separation or tracking.</li> </ol>
57	Transformer Overtemperature Occurred	<p>Wait several minutes and repeat the test, leaving the test set on until the fan turns on to cool it. If the fan does not eventually turn on, see "Fan Operation" on page 4-50.</p>
63	Voltage Input Saturated	<p>Replace the Guard Board (see "Replacing the Guard Board" on page 4-76).</p>
64	Requested Maximum Voltage Exceeded	<p>Replace the Guard Board (see "Replacing the Guard Board" on page 4-76).</p>

**Table 4.5 Error Messages (Continued)**

#	Error Message	Suggested Action
133	No Response from M4000, Check Connections &	<ol style="list-style-type: none"> <li>1. Make sure the M4100 is turned on.</li> <li>2. For All Error Numbers in the 130's: If the error appears during a test, there may be another application running on your computer which is interfering with communication to the M4100. Contact Doble for analysis and solution to this problem. To begin with, remove all but the M4000 program from your startup menu.</li> </ol>
137	Invalid Message Number	<ol style="list-style-type: none"> <li>3. If you are using a laptop PC in place of the M4200c, select "Configuration" from the "Tools" menu, click the "Instrument" tab, and select "Com1" for Serial Port, save and exit.</li> <li>4. If using a USB to Serial adapter, make sure the software driver has been installed.</li> <li>5. Run the Communications Loopback Test as described in "Communications Loopback Test" on page 4-40.</li> <li>6. Check the voltage between either safety switch's Pin 3 (third from left) and the chassis. If less than 4.9 V, reseal both ends of the W46 cable (see "W46 Cable Checkout" on page 4-55).</li> <li>7. Check the operation of the Low Voltage Power Supply Board by following the procedure given in "Low-Voltage Power Checkout" on page 4-51.</li> </ol>

## Troubleshooting from Diagnostics

The M4000 test set supports automated diagnostic tests that are useful in validating system operation and troubleshooting problems that may occur. Diagnostics should be run on a regular basis to ensure that the M4000 Insulation Analyzer is functioning properly. The Diagnostics should also be used to investigate potential causes of error messages.

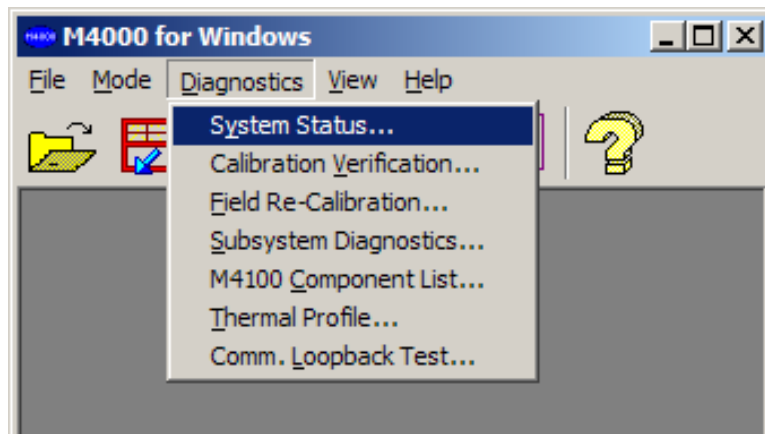
### Running Diagnostics

Diagnostics can be accessed from the *Diagnostics* pull-down menu. Access the menu by clicking on *Diagnostics* in the menu bar, as shown in Figure 4.2. The following seven tests are available:

**NOTE**  


**The M4150 and M4151 Calibration References are optional, and the Calibration Verification and Field Recalibration diagnostic tests cannot be run if they are unavailable. Furthermore, certain remedial procedures described in the System Status section cannot be completed without them.**

- System Status (page 4-23)
- Calibration Verification (page 4-26)
- Field Recalibration (page 4-31)
- Subsystem Diagnostics (page 4-34)
- M4100 Component List (page 4-38)
- Thermal Profile (page 4-39)
- Communications Loopback Test (page 4-40)



*Figure 4.2 Diagnostics Pull-Down Menu*

The first six of these tests are applicable to the M4100; the last one is not. Use of the Communications Loopback Test is described in "Communications Loopback Test" on page 4-40.

Follow these recommendations in deciding when to run each test:

<b>Diagnostic Test</b>	<b>Run the test when suggested by a displayed message, when indicated in a troubleshooting flow chart or table, or:</b>
System Status *	Run this test if you are experiencing any malfunction or error.
Calibration Verification*	<ol style="list-style-type: none"> <li>1. Run this test periodically to run a mock specimen measurement, which checks all system connections, including high and low voltage cables.</li> <li>2. Run this test after replacing a component or otherwise repairing the M4100.</li> </ol>
Field Recalibration	Run to calibrate the test set when one of the calibration verification tests results in a <b>Fail</b> or <b>Re-cal</b> rating.
Subsystem Diagnostics	Run this test to exercise specific M4100 components.
M4100 Component List	Run this test to obtain a list of recognized M4100 components and their revision numbers.
Thermal Profile	Run this test if the M4100 appears to be overheating or if an over-temperature indication appears.
Communication Loopback Test	Run to check communications between the M4200c Controller (or laptop) and the M4100 Instrument.

\* When contacting Doble by telephone or e-mail (customerservice@doble.com), it will be helpful to have the results from these two tests, including the contents of the *Calver.log* file, located in the *DTA* directory.



Once the operator specifies a particular diagnostic test to run, the following function keys are available for use:

- |           |                             |
|-----------|-----------------------------|
| <b>F1</b> | Display Help contents       |
| <b>F2</b> | Run the selected diagnostic |

Following are descriptions of each of the five Diagnostics tests that are applicable to the M4100.

## System Status

### NOTE



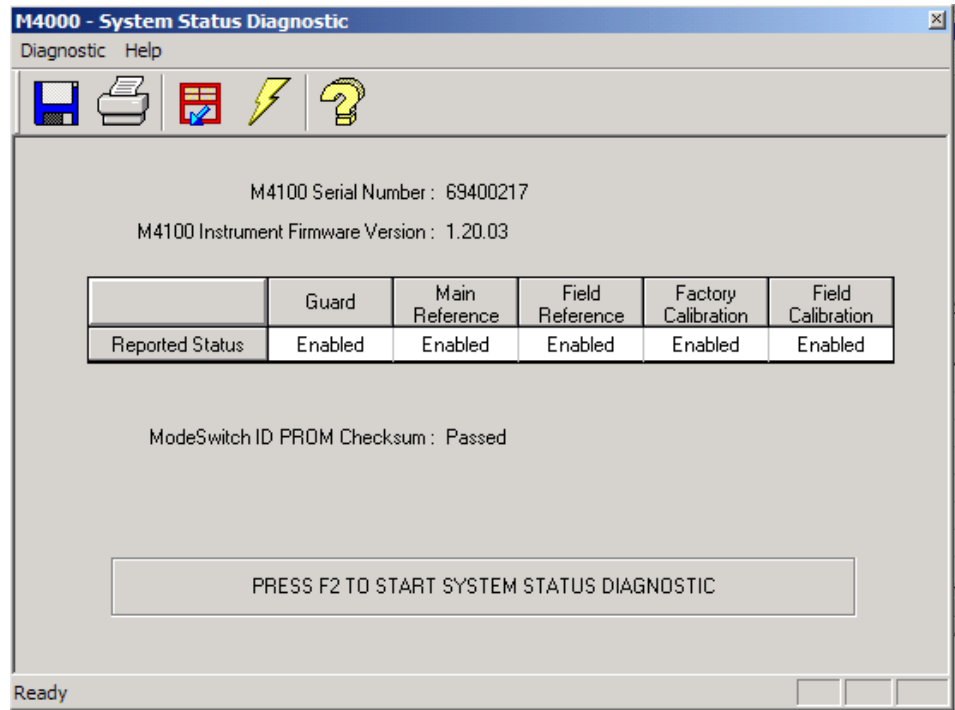
**Do not run this test when the temperature is below freezing.**

The System Status diagnostic determines and reports the calibration status of the Guard Board, Main Reference Assembly, Field Calibration Reference and Backplane. It also performs a checksum test of the Guard Mode Switch Board's ID PROM.

To run the System Status diagnostic:

1. Select *System Status* from the *Diagnostics* pull-down menu.
2. Press **F2** to start the test.

A display like that shown in Figure 4.3 appears when the test is complete. The results can be printed or saved as a file using options in the *File* pull-down menu.



**Figure 4.3 System Status Test Results**

This test is passed when every item’s status is reported as Enabled. Any other result has the following implications:

Guard Status Disabled

Critical: This condition must be corrected before testing continues.

Corrective Procedure: Replace the Guard Board and run the Field Recalibration Test.

The consequences of continued testing in the uncorrected state are:

- Calibration Verification cannot be performed
- Measurement error uncertainty (2% Capacitance relative and 0.1% Power Factor absolute)
- Guard failure in Subsystem Diagnostics

Main Reference Status Disabled

Critical: This condition must be corrected before testing continues.

Corrective Procedure: Replace the Main Reference Assembly and run the Field Recalibration Test.

The consequences of continued testing in the uncorrected state are:

- Calibration Verification cannot be performed

Field Reference Status Disabled	<ul style="list-style-type: none"> <li>• Measurement error uncertainty (1% Capacitance relative and 0.15% Power Factor absolute)</li> <li>• Retest failure in Subsystem Diagnostics</li> </ul>
	<p>Non-critical:                This condition must be corrected before Calibration Verification can be performed.</p> <p>Corrective Procedure: Replace the Field Calibration Reference.</p> <p>The consequences of continued testing in the uncorrected state are:</p> <ul style="list-style-type: none"> <li>• Calibration Verification cannot be performed</li> <li>• Calibration Reference (Calref) failure in Subsystem Diagnostics</li> </ul>
Factory Status Disabled	<p>Non-critical:                This condition may be caused by any of the following:</p> <ol style="list-style-type: none"> <li>1. A calibration dependent assembly has been changed.**</li> </ol> <p>Corrective procedure: Run the Calibration Verification.</p> <ol style="list-style-type: none"> <li>2. Guard Mode Switch IDPROM checksum test failed.</li> </ol> <p>Corrective procedure: Replace the Guard Mode Switch Board and run the Calibration Verification.*</p> <ol style="list-style-type: none"> <li>3. Either the Guard status or Main Reference status is disabled.</li> </ol> <p>Corrective procedure: Refer to the foregoing results and run the Calibration Verification.</p>
	<p>* It may be possible to correct an ID PROM checksum failure without replacing the Guard Mode Switch Board; call Doble.</p> <p>** Calibration dependent assemblies are:</p> <ul style="list-style-type: none"> <li>• - Guard Board</li> <li>• - Main Reference Assembly</li> <li>• - Guard Modeswitch Board</li> <li>• - System BackPlane</li> </ul> <p>The Consequences of continued testing in this state are:</p> <ul style="list-style-type: none"> <li>- Calibration Verification Test can be performed if the cause is due to changed assembly</li> <li>- Subsystem Diagnostics will fail bptest Test</li> <li>- Measurement error uncertainty (.25% Capacitance relative and .04% Power Factor absolute.)</li> </ul>

**If none of the above applies and all statuses are ENABLED the problem is likely to be the inability to successfully complete a Calibration Verification test. Run the diagnostic and the results should indicate the problem.**

**NOTE**  
☞ **If the corrective procedures described do not fix the System Status error then Call Doble.**

## Calibration Verification

**NOTE**  
☞ **For a simple check of the M4000 Insulation Analyzer's measurement system, test the empty Doble Liquid Insulation Cell, energized at 5 kV. See "Checking Instrument Accuracy in the Field" on page 4-43.**

A more comprehensive check can easily be performed in the form of the Calibration Verification. It is suggested that a Calibration Verification be performed (providing the optional M4150 or M4151 Calibration Reference is available):

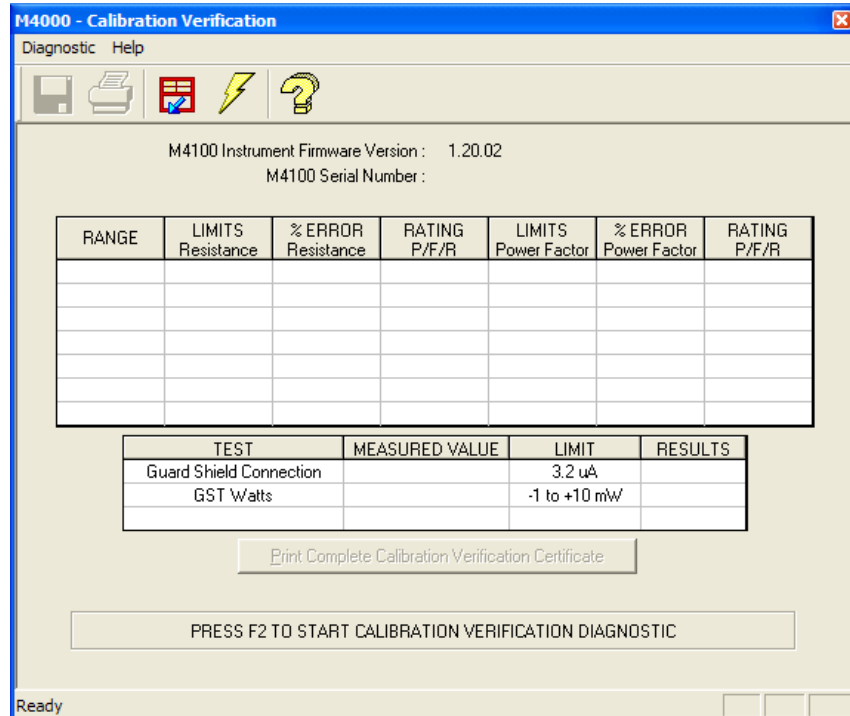
- Upon receipt of an M4000 Insulation Analyzer from Doble or from another location within your company
- At monthly intervals
- When questionable readings are obtained

The Calibration Verification provides the quickest assurance that the measurement system and the test leads are working correctly. It exercises the red and blue resistors, the guard connection of the high voltage lead, and tests GST internal loss.

**NOTE**  
☞ **Do not run this test when the temperature is below freezing.**  
**Prior to performing a Calibration Verification, run the System Status diagnostic (page 4-23) to ensure that all system variables are enabled.**  
**The figures in the example below reflect the use of the M4150 Calibration Reference.**

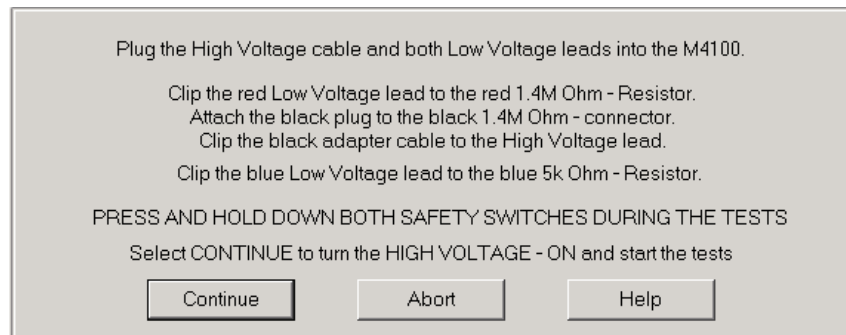
To perform the Calibration Verification:

1. Select *Calibration Verification* from the *Diagnostics* pull-down menu.  
The screen shown in Figure 4.4 appears.



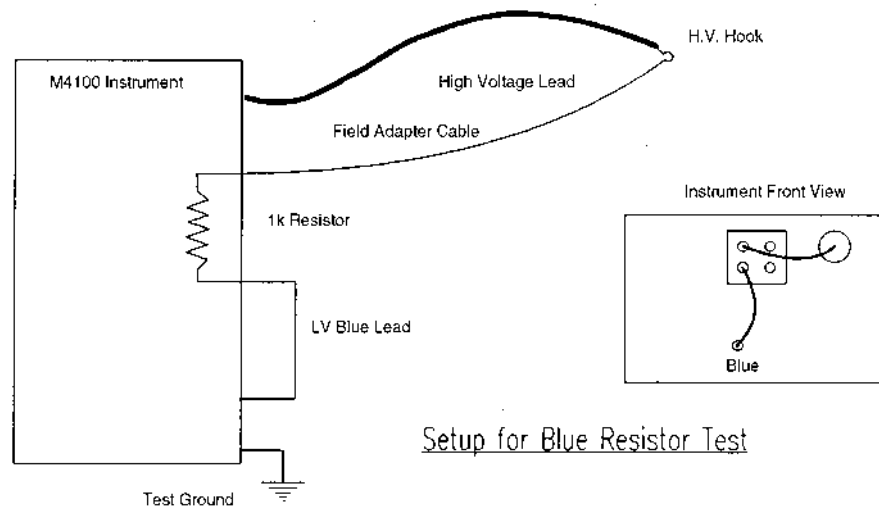
**Figure 4.4 Calibration Verification Initial Screen**

2. Press **F2**.
3. Follow the on-screen directions, as shown in Figure 4.5.

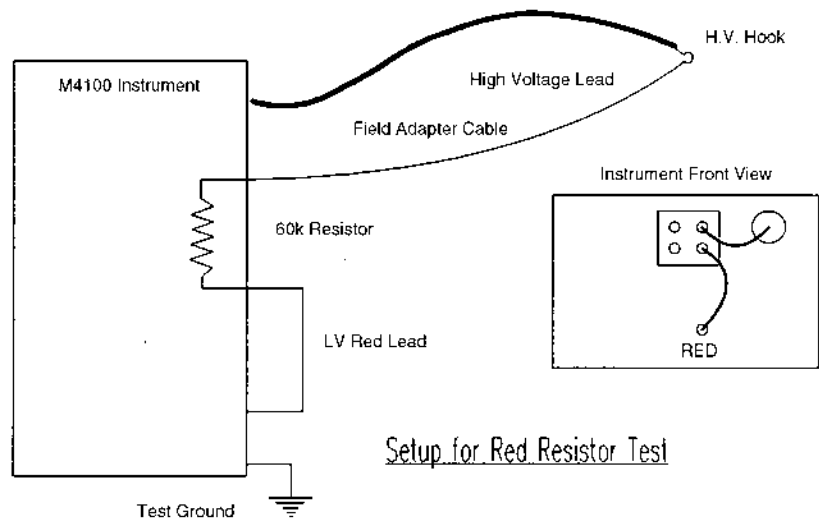


**Figure 4.5 Calibration Verification Instructions**

Connections for the Calibration Verification are shown in Figure 4.6 and Figure 4.7. The Field Adapter cable, shown in these figures, is an accessory cable found in the cable bag which connects from the High Voltage Test Cable to the black connectors on the Field Calibration Reference.



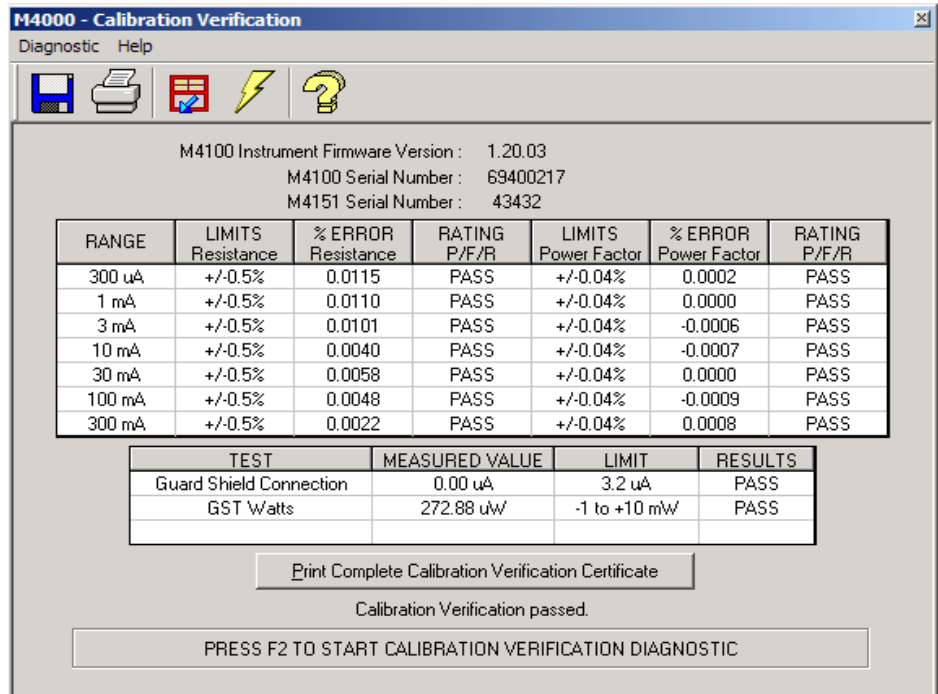
**Figure 4.6 Setup for Blue Resistor Test**



**Figure 4.7 Setup for Red Resistor Test**

There is a test abort criterion described in the first test of each setup. The test abort allows the operator to correct a setup error and then restart from the point where the error was first detected, without losing successfully completed test information.

At the conclusion of the Calibration Verification, a summary table like that shown in Figure 4.8 will be displayed.



**Figure 4.8 Calibration Verification Results**

The summary table can be printed or saved as a text file. Both options are available on the *File* pull-down menu.

#### Calver.log File

Upon completion of the Calibration Verification, the M4000 software creates a file named *Calver.log* and stores it in the *DTA* directory. This file summarizes information on test aborts and test failures. An example of such a file is shown in Figure 4.9.

Test Date: 06/29/95  
Test Time: 10:14:45  
System Serial Number = 59400175  
Test Fail: 3mA SinTheta = -0.045979%  
Final Error Code = 00-00-0-04H  
End of Test

Test Date: 04/03/96  
Test Time: 14:33:16  
System Serial Number = 59400175  
Final Error Code = 00-00-00-00H  
End of Test

Test Date: 04/26/96  
Test Time: 10:48:42  
System Serial Number = 59400175  
Test Abort: Error #53  
Test Not Running -  
One or Both Low Voltage Leads Disconnected  
Final Error Code = 00-00-00-00H  
End of Test

Test Date: 04/26/96  
Test Time: 10:50:43  
System Serial Number = 59400175  
Test Abort: Error #53  
Test Not Running -  
One or Both Low Voltage Leads Disconnected  
Final Error Code = 00-00-00-00H  
End of Test

***Figure 4.9 Example of Calver.log File Contents***

Additional data are continually added to the file by each subsequent Calibration Verification. The print option, if selected at the end of a test, prints only results from the test just completed.

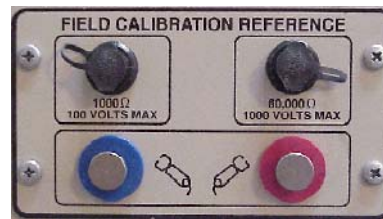
When a failure is encountered, Doble can provide troubleshooting guidance if needed. A copy of the *Calver.log* file, found in the DTA directory, is essential.



## Field Recalibration

Run this test if any of the Calibration Verification test ratings are **Re-Cal** or **Fail**. With the M4100 Field Calibration feature, calibration can be done in the field for 7 of the current ranges if the optional M4151 Field Calibration Reference is used, and for 3 ranges if the optional M4150 Field Calibration Reference is used. The optional Field calibration Reference, if available, is located on the face of the M4100 Instrument. Test result information may be found in the fieldcal.log and currfcacal.log files, both found in the DTA directory.

### The Optional M4150 Field Calibration Reference



*Figure 4.10 M4150 Field Calibration Reference*

This is the reference box that has been used since the inception of the M4000. Using the M4150, the M4000 software performs a reference test on the test set for the three middle current ranges (10, 30, and 100 mA). The M4100 calibration can be checked, and, if necessary, adjusted. Except for special certification requirements, usually reserved for testing at Nuclear Power Plants, the reference check and calibration made possible by the M4150 should be more than adequate to assure accurate data.

### The Optional M4151 Field Calibration Reference



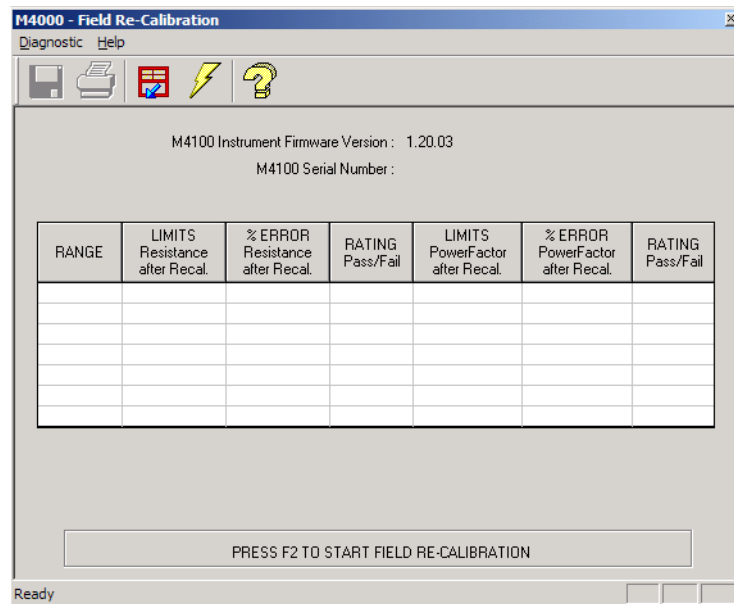
*Figure 4.11 M4151 Field Calibration Reference*

For situations demanding more complete calibration, Doble offers the M4151 Field Calibration Reference. Using this option, seven current ranges can be checked and calibrated (leaving only the three high current ranges used with a resonator unchecked). The seven ranges tested by the M4151 are 300  $\mu$ A, 1 mA, 3 mA, 10 mA, 30 mA, 100 mA, and 300 mA. These three high current ranges not tested require both a resonator and an external capacitor for checking and field calibration, and are not available.

To perform a Field Recalibration test:

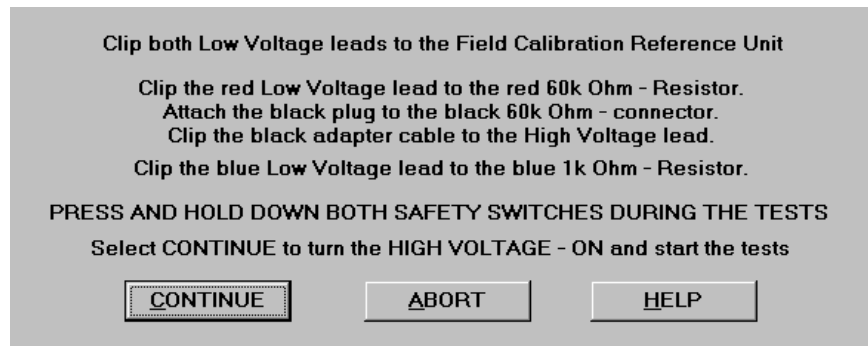
1. Select *Field Recalibration* from the *Diagnostics* pull-down menu.

The screen shown in Figure 4.12 appears.



**Figure 4.12 Field Recalibration Main Screen**

2. Press **F2**
3. Follow the on-screen directions, as shown in Figure 4.13.



**Figure 4.13** *Field Recalibration Instructions*

The Field Adapter cable is an accessory cable which connects from the High Voltage Test Cable to the black connectors on the Field Calibration Reference.

There is a test abort criterion described in the first test of each setup. The test abort allows the operator to correct a setup error and then restart from the point where the error was first detected, without losing successfully completed test information.

At the conclusion of the Field Recalibration, a summary table like that shown in Figure 4.14 will be displayed.

M4000 - Field Re-Calibration

Diagnostic Help

M4100 Instrument Firmware Version : 1.20.03  
M4100 Serial Number : 69400217  
M4151 Serial Number : 43432

RANGE	LIMITS Resistance after Recal.	% ERROR Resistance after Recal.	RATING Pass/Fail	LIMITS PowerFactor after Recal.	% ERROR PowerFactor after Recal.	RATING Pass/Fail
300 uA	+/-0.5%	0.0005	PASS	+/-0.04%	-0.0017	PASS
1 mA	+/-0.5%	0.0051	PASS	+/-0.04%	0.0000	PASS
3 mA	+/-0.5%	0.0133	PASS	+/-0.04%	0.0002	PASS
10 mA	+/-0.5%	-0.0002	PASS	+/-0.04%	-0.0005	PASS
30 mA	+/-0.5%	0.0038	PASS	+/-0.04%	-0.0005	PASS
100 mA	+/-0.5%	0.0066	PASS	+/-0.04%	-0.0001	PASS
300 mA	+/-0.5%	0.0098	PASS	+/-0.04%	-0.0011	PASS

Field Re-Calibration - Completed

PRESS F2 TO START FIELD RE-CALIBRATION

Ready

**Figure 4.14** *Field Calibration Results*

The summary table can be printed or saved as a text file. Both options are available on the *File* pull-down menu.

Fieldcal.log File

Upon completion of the Field Recalibration, the M4000 software creates a file named *Fieldcal.log* and stores it in the *DTA* directory. This file summarizes information on test aborts and test failures.

## Subsystem Diagnostics

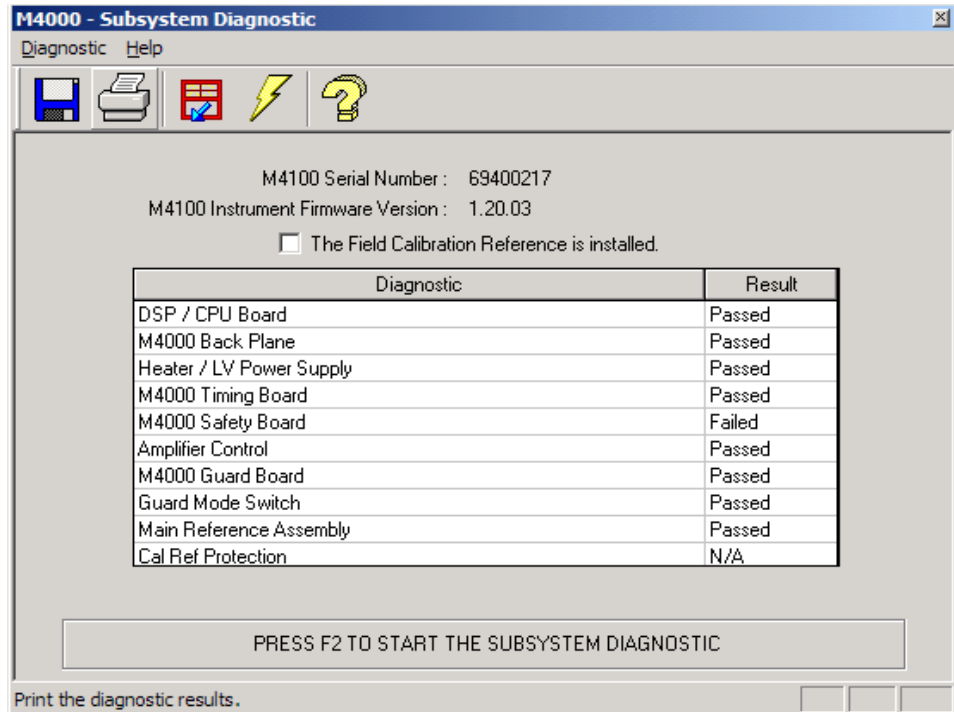
Subsystem Diagnostics checks numerous M4100 components. It first verifies proper communications between the M4200c Controller and the M4100 Instrument, then runs tests on the following M4100 components:

- DSP/CPU Board
- Backplane
- Low Voltage Power Supply Board
- Heater/Temperature Controller Board
- Timing Board
- Safety Board
- Amplifier Assembly
- Guard Board
- Guard Mode Switch Board
- Main Reference Assembly
- Field Calibration Reference

To perform these diagnostics:

1. Select *Subsystem Diagnostics* from the *Diagnostics* pull-down menu.
2. Press **F2** to start the process, which takes several minutes.

When all the tests are completed, the result (PASSED or FAILED) for each M4100 Component is reported, as in Figure 4.15.

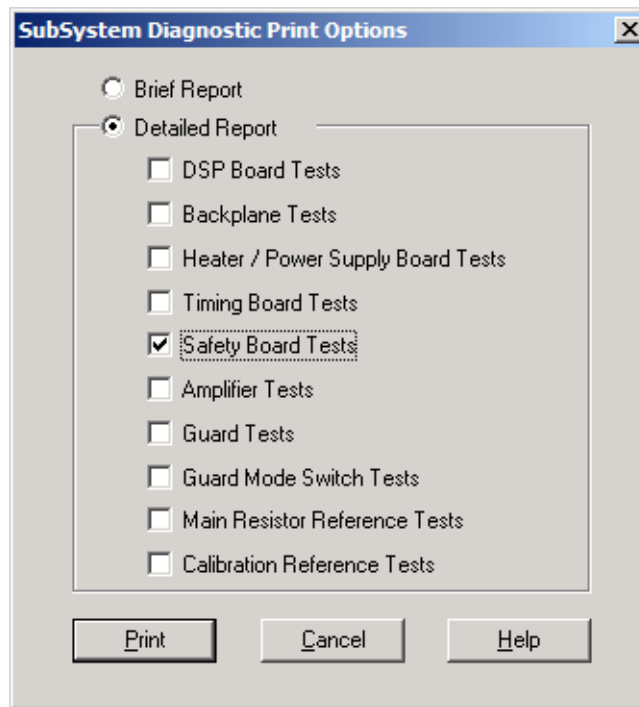


**Figure 4.15 Subsystem Diagnostics Results**

Results can be printed either in brief or in full. To print the test results:

3. Select *Print* from the *File* menu.

The screen shown in Figure 4.16 appears, allowing a choice of the level of detail to be printed.



*Figure 4.16 Print Detail*

A **Brief Report** contains the text that is displayed on the results screen. If **Detailed Report** is selected, all the fields shown above become active, allowing the operator to select which specific components' test results to print. In the example above, since the Safety Board diagnostic failed, that result is selected for a full printout.

The printed test result resulting from a typical choice is provided in Figure 4.17. Such a printout is useful if the operator finds it necessary to consult Doble for assistance.

Subsystem Diagnostics Results				Page 1
09/25/99 11:15				
-----				
M4100 Serial Number: 109600844				
M4100 Instrument Firmware Version: 1.20.00				
Running M4kTim.BAS Version: 1.14.00 on Date: 09-25-1999 Time: 11:00:11				
TNum	Test Name	P/F	Test Result	Comment
-----				
# 2	ID header check	P	23055	should be 23055
	Board Name:		M4000 Timing Board	
	Board Number:		04D-0533-01	
	Board Revision:		E	
	Serial Number:		33505	
	Write Count:		1	
	Header Version:		1	
	Test Technician:		DP	
	Test Date:		09/24/99	
	No Calibration Header			
# 3	Test of ID header & checksum	P	0	0 = OKAY, -1 = INVALID
# 5	Check of Output Port #0	P	0	Recp!
# 6	Check of Output Port #40h	P	0	
# 7	Test of Divided-down Crystal	P	0	
# 8	Test of 60hz & PLL,Bypass Gd	P	0	
# 9	Test SAMPLE Clk,bypass Guard	P	0	Bypasses Guard bd
# 10	Test of 60 hz & PLL w/Guard	P	0	Uses Guard bd
# 11	Test of SAMPLE Clk w/Guard B	P	0	Depends on Guard bd
# 12	Checking low end of PLL w/Gr	P	0	Test at 43 hz
# 13	Checking hi end of PLL w/Grd	P	0	Test at 71 hz
# 14	Test of L/R from Guard Bd	F	0	WRONG freq = STR\$(me
# 15	Test of FSYNC from Guard Bd	P	0	
# 16	Test unlock bit not stuck on	P	3	PLL does unlock-OK
# 17	PLL Check with Line Sync	P	0	
M4KTIM Rev: 1.14.00 FAILED test 14: Test of L/R from Guard Bd				
*****				
*****				

**Figure 4.17 Component Test Result, Subsystem Diagnostics**

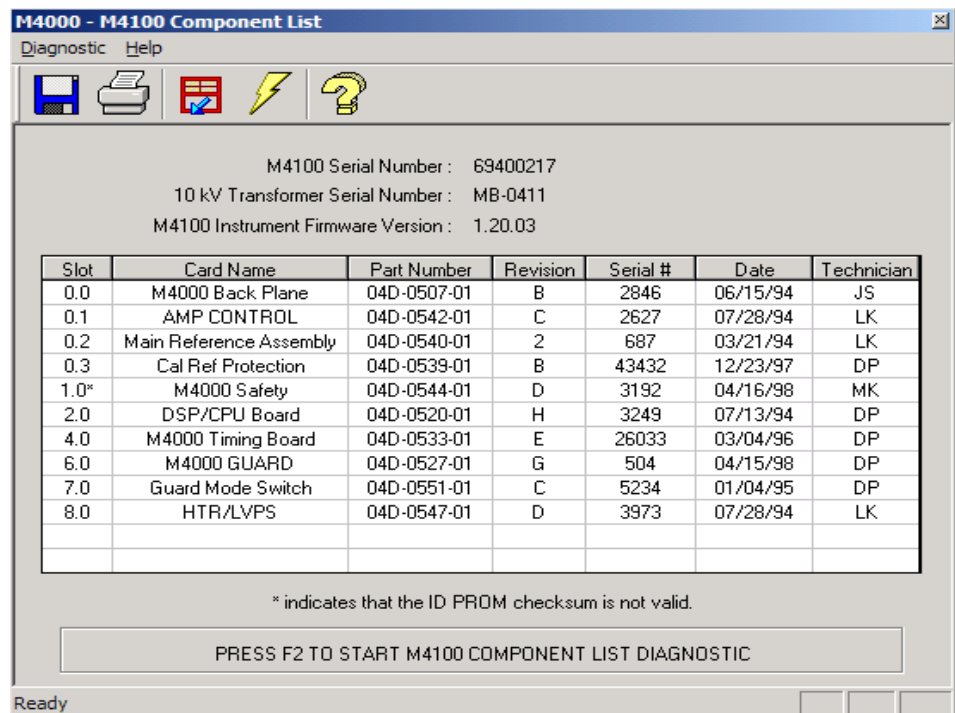
## M4100 Component List

The M4100 Component List provides a listing of recognized system components, which is helpful in diagnosing certain problems. The listing characterizes each component as to its identity and calibration history.

To generate this list:

1. Select *M4100 Component List* from the *Diagnostics* pull-down menu.
2. Press **F2**.

Figure 4.18 shows an example of the resulting list.



**Figure 4.18** M4100 Component List Results

This summary can be printed or saved to a file via the *File* menu.



## Thermal Profile

The Thermal Profile diagnostic displays internal and external temperatures measured by the M4100.

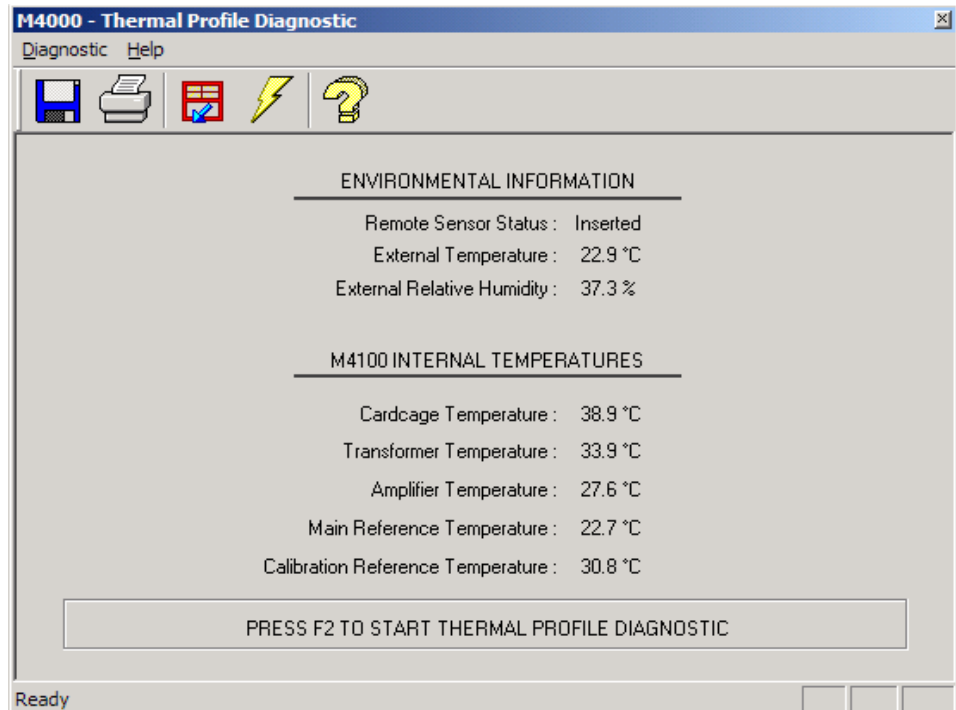
**NOTE**  


**To monitor external parameters the Remote Sensor must be connected to the M4100.**

To run a Thermal Profile:

1. Select *Thermal Profile* from the *Diagnostics* pull-down menu.
2. Press **F2**.

As the profile is running, continuously updated temperature and humidity values are displayed on the screen, as exemplified in Figure 4.19.



*Figure 4.19 Thermal Profile Results*

3. Stop the monitoring by pressing **F4** or **ESC**.

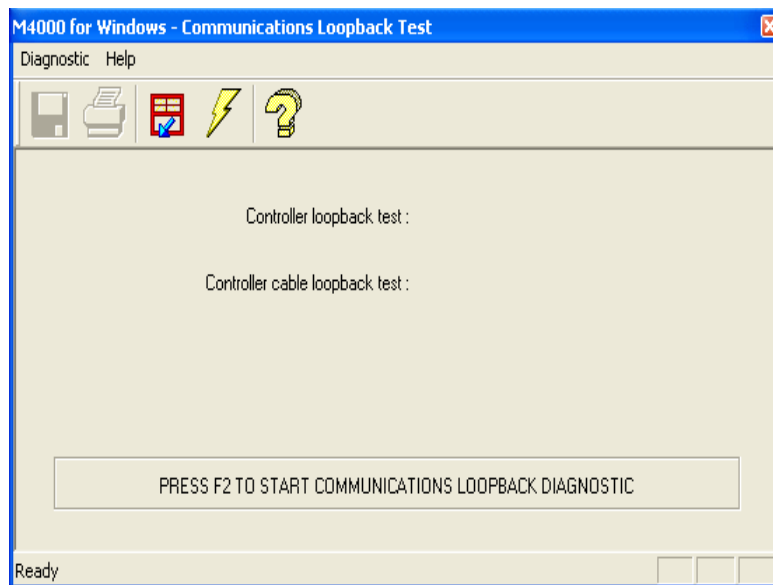
Once the update process is stopped, results can be printed or saved to a file via the *File* menu.

## Communications Loopback Test

The Communications Loopback Test is run to assure that proper communications exist between the M4200c and M4100. It should be run whenever a communications error occurs.

This test verifies the serial link between the M4200c and the M4100 using two external Burndy connector pieces (male and female types) included in the Accessories Bag. If these connectors cannot be located, contact Doble (see items 29 & 30, page A-3).

The Communications Loopback Test is run by selecting that option (Figure 4.20) from the Diagnostics pull-down menu and following the on-screen instructions.



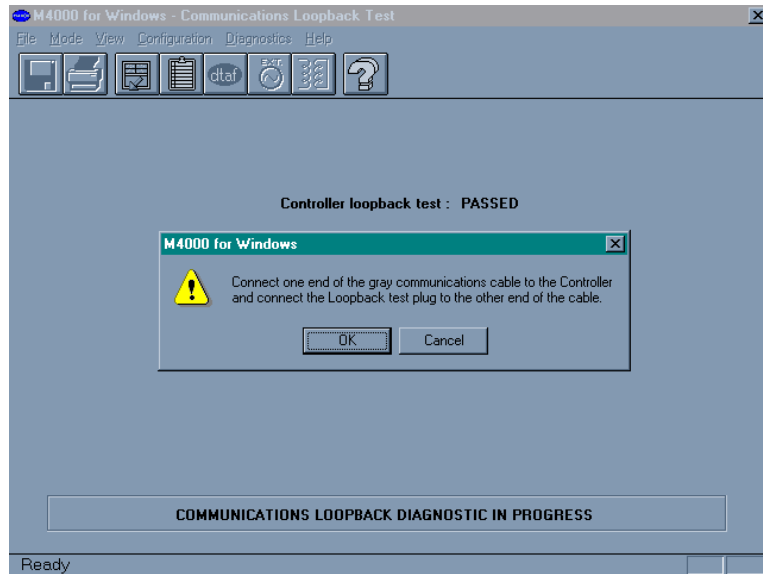
*Figure 4.20 Running the Communications Loopback Test*

The M4000 Software prompts the operator to perform the same test twice, with and without the communications cable in place. If both tests pass and a communications problem still exists, the M4100 LVPS is probably at fault.

Proceed as follows:

1. Follow the directions provided in Figure 4.20, i.e., remove the communications cable from the M4200c and replace it with the test plug. Then press **F2** to start the test.

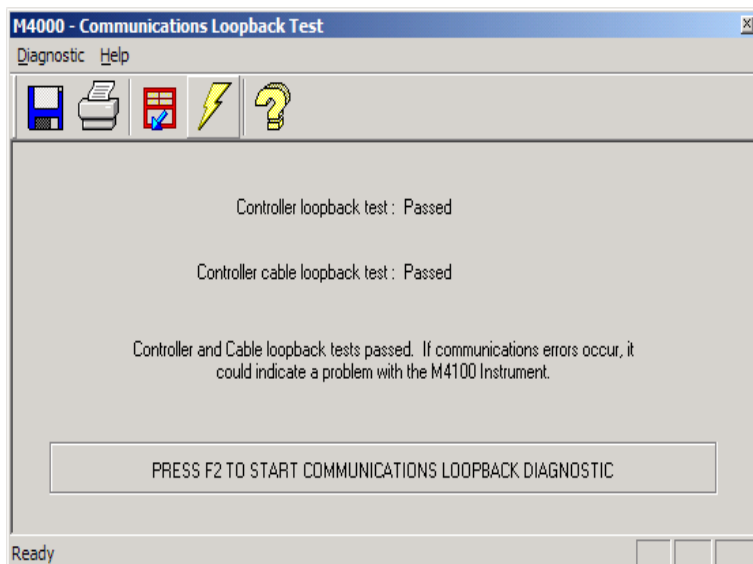
A screen like that shown in Figure 4.21 will appear when the first test is complete. In this example the first loopback test passed.



*Figure 4.21 Communications Loopback Test, First Result*

2. Follow the directions provided in Figure 4.21, i.e., remove the test plug and connect the communications cable in its place, then attach the other test plug to the far end of the cable. Press **OK** to continue.

A screen like that shown in Figure 4.22 will appear when the second test is complete. In this example both loopback tests passed.



*Figure 4.22 Communications Loopback Test, Final Results*

## Running Other Tests

Certain additional tests can be run without gaining access to the M4100 interior. Any of the following tests can and should be run based upon an indicated error message, symptom or diagnostic test result.

## Checking the High Voltage Test Cable

Most of the difficulties encountered with the High Voltage Test Cable are of a mechanical nature, external, and easily identified. The following resistance measurements are helpful in locating internal defects that cause erratic or otherwise abnormal test results.

**NOTE**



**The High Voltage Test Cable must be isolated for the following measurements. Disconnect it from the M4100 and the specimen.**

Continuity

The end-to-end resistance of each cable conductor (i.e. the center conductor, guard shield and ground shield), measured with a low-voltage ohmmeter, should be less than 1 ohm. If any conductor's resistance is greater, replace the High Voltage Test Cable.

DC Insulation Resistance

The DC resistance of insulation between cable circuits (i.e. center conductor to guard shield and guard shield to ground shield), measured with a low-voltage instrument (500 V or less) at either end of the cable should be 100 megohms or greater. If any insulation resistance is less, replace the High Voltage Test Cable.

## Checking the Low Voltage Test Leads

The Low Voltage Test Leads are both single-conductor shielded cords terminated by a clip on one end and a locking plug on the other. Note that Pins 1 and 2 of the inboard connector are short-circuited to each other and connected to the lead shield. Pin 3 is connected to the center conductor of the lead to which a clip is attached at the outboard end.

**NOTE**



**The Low Voltage Test Leads both must be isolated from the M4100 for the following measurements. Both leads should be tested.**

Continuity	<p>The center conductor and shield should each have less than 1-ohm resistance.</p> <p>The center conductor's resistance is measured between the clip and Pin 3 of the inboard connector. In order to check the shield, penetrate the outer insulation of the lead (approximately 1-2 inches from the outboard clip) using a thin/sharp pointed electrode (pointed ohmmeter probes are suitable for this purpose). The shield resistance is measured between Pins 1 or 2 of the inboard connector and the ohmmeter probe penetrating the insulation.</p> <p>If either conductor's resistance is greater than 1 ohm, replace that Low Voltage Test Lead.</p>
DC Insulation Resistance	<p>The DC insulation resistance of a lead, measured with a low-voltage instrument, between the center conductor and shield should be 100 megohms or greater. This measurement is made by connecting one probe of the DC instrument to the clip at the lead's outboard end, and the other probe connected to the shield (Pins 1 and 2 of the lead's inboard connector).</p> <p>If abnormally low insulation resistance is observed, the condition of the insulation between the center conductor and shield at the clip end of the lead should be checked.</p> <p>If any insulation resistance is less than 100 megohms, replace that Low Voltage Test Lead.</p>

### Checking M4100 Guard-to-Ground Insulation

The DC insulation resistance between the Guard and Ground circuits of the M4100 should be in the range 2.5-4 megohms. The measurement is made between the blue and silver terminal posts on the front panel, with the M4100 turned off and the AC power cord removed. A low-resistance path between these points is a frequent cause of large negative values of GST watts, especially when running the Field Recalibration Test diagnostic.

If a short or low resistance is detected between these points on the front panel, perform the internal checks described in "Guard-to-Ground Shorting Problems" on page 4-51.

**NOTE**  


**The short circuit may be intermittent, so it may be necessary to move or shake the instrument in order to stimulate the short.**

### Checking Instrument Accuracy in the Field

In lieu of elaborate laboratory checks, it has been found that the Doble Liquid Insulation Cell, properly cleaned and dried, is a reliable standard that can be used in the field for a quick, simple accuracy check.

The characteristic charging current (capacitance) and watts-loss of the Liquid Insulation Cell should be measured whenever a new instrument or cell is received, and the test data should be recorded for future reference. The test connections and procedure are the same as for testing a liquid-insulation sample, except that the test is conducted in *both* the UST and GST modes. The cell should be clean and dry, and a stable voltage source should be utilized.

Typically, a clean and dry Liquid Insulation Cell check produces results approximately as follows by the UST method:

Test Voltage	Current	Capacitance	Watts-Loss
5 kV	400 microamperes	106 pF	+0.0020

**NOTE**  


**In the absence of insulating liquid, the dielectric-breakdown strength of the Liquid Insulation Cell is significantly reduced. Due to the relatively close spacing of the cell plates, an internal flashover will likely occur around 7 or 8 kV when the cell is dry.**

The charging current measured is a function of the geometric dimensions of the cell and, therefore, some variation may occur between different cells; however, the current reading should be repeatable when using the same cell, properly assembled with electrode spacings unchanged. The measured current and watts-loss will be slightly higher when the calibration is checked by the GST method owing to stray capacitive coupling to ground.

## Voltage Verification

The factory performs voltage accuracy tests at 5kV using a high voltage RMS voltmeter (Valhalla, model 4600). The following procedure is a similar voltage verification test performed at a reduced voltage (500 Volts).

Additional Instrumentation Required:

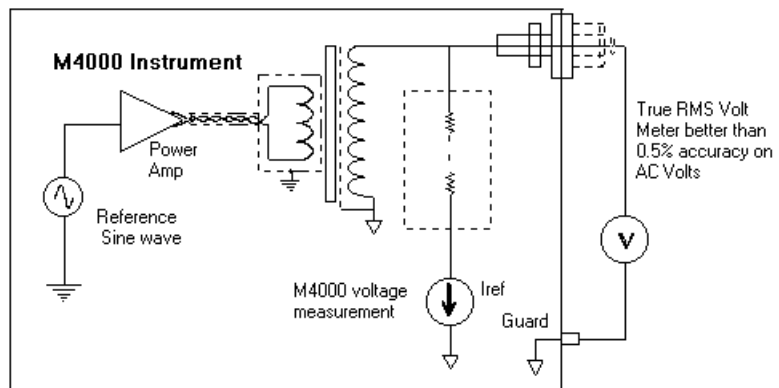
Digital Voltmeter (DVM) with a minimum input capability of 750 VRMS and an accuracy of +/- 0.5% on the AC Volt scale. The following models are acceptable for doing a reduced voltage measurement test in the field; Fluke models 8060A, 8025A, Fluke 85, Fluke 25, Fluke 27 or equivalent.

Test Setup:

- Test set must be grounded and the High Voltage Lead connected. Confirm the center conductor of the High voltage Cable is isolated from ground.
- Connect the DVM from the High Voltage Lead center conductor to the Guard circuit (blue terminal on the front panel of the M4100 instrument).

- Select the Clipboard mode to perform the test and configure a test with the potential of 500V. The test must be performed in Manual mode, and any test circuit will do.
- Raise the test voltage to 500V and record the DVM reading on the Calibration Verification Certificate.

The setup for the test is shown in the following diagram:



## Accessing M4100 Components

**DANGER**



**Ensure that the AC power cable is disconnected prior to removing any of the M4100 covers. To avoid static discharge, ground yourself and the test set before handling any circuit boards.**

The following procedures require access to internal M4100 components:

- Performing internal checks
- Replacing internal components for purposes of diagnosis and repair
- Upgrading components

This section provides guidance in accessing M4100 internal components and identifying those components and their interconnections. Subsequent replacement procedures are detailed in "Replacing M4100 Components" on page 4-56.

Access to all internal M4100 components requires removal of the instrument's front and top covers. Access to certain components, notably many of the instrument's PC boards, also requires removal of the card cage cover. Instructions for both actions are provided below.

**DANGER**



**Always disconnect AC power before gaining access to internal M4100 components. If re-application of power is necessary to perform an internal check, follow the procedural instructions carefully to minimize the risk of electrical shock. In particular, make certain that only voltmeter probes come in contact with internal test points. Furthermore, the High Voltage Test Cable and Safety Switch extension must always be disconnected from the Transformer case during internal measurement and inspection.**

## Removing the Front and Top Covers

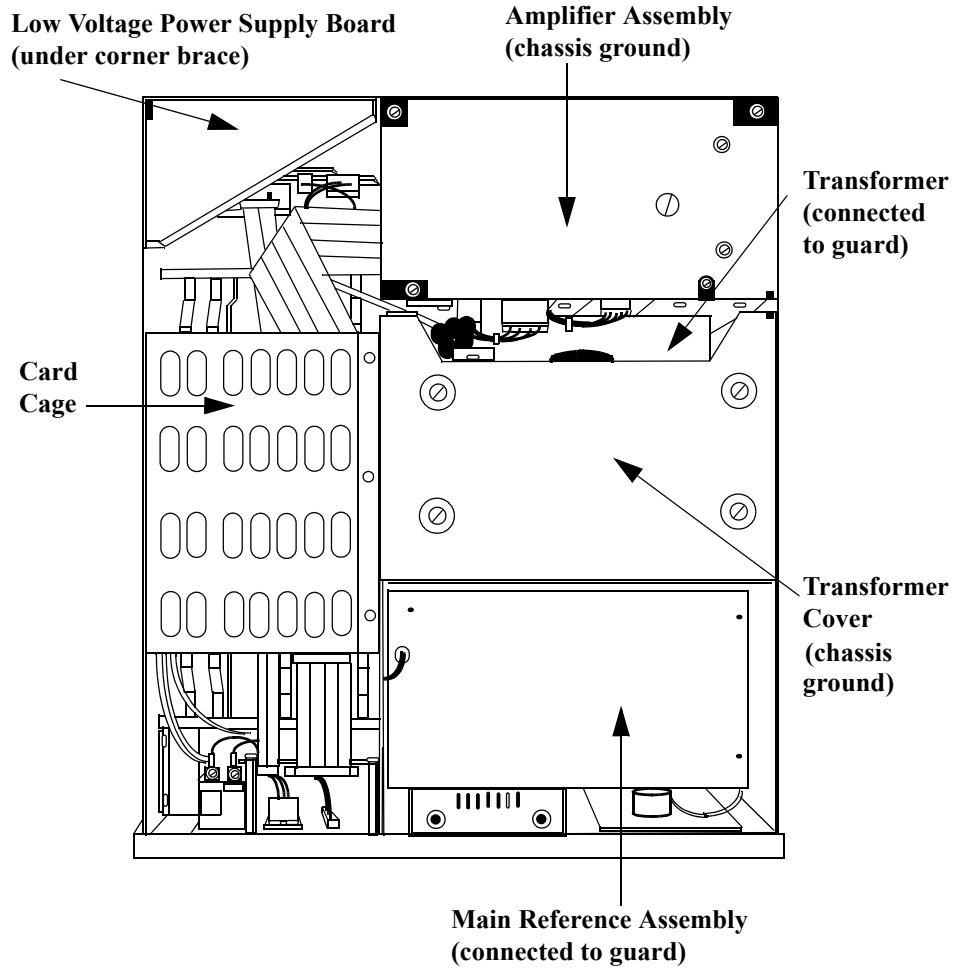
The front and top covers must be removed to gain access to internal components. Keep screws that are removed together in a safe location for re-assembly.

Take the following steps to remove the covers:

1. With the power cable disconnected, snap off the front cover. To do so, stand facing the unit and grip the edges of the front cover panel with both hands while pulling towards you. Then, turn the unit around so that the black rubber feet are facing you.
2. Use a flat-blade screwdriver to remove the top two rubber feet.
3. Lift the top cover up and towards the rear. Then, turn the unit around again so that the front panel is facing the operator.



The resulting top view of the instrument is as shown in Figure 4.23.



*Figure 4.23 M4100 Interior View*

## Removing the Card Cage Cover

The card cage cover must be removed to gain access to any of the following components:

- DSP/CPU Board
- Guard Board
- Guard Mode Switch Board
- Safety Board
- Timing Board

**NOTE**  
⚠

**These PC boards are sensitive to static electricity. Observe the following precautions when handling them.**

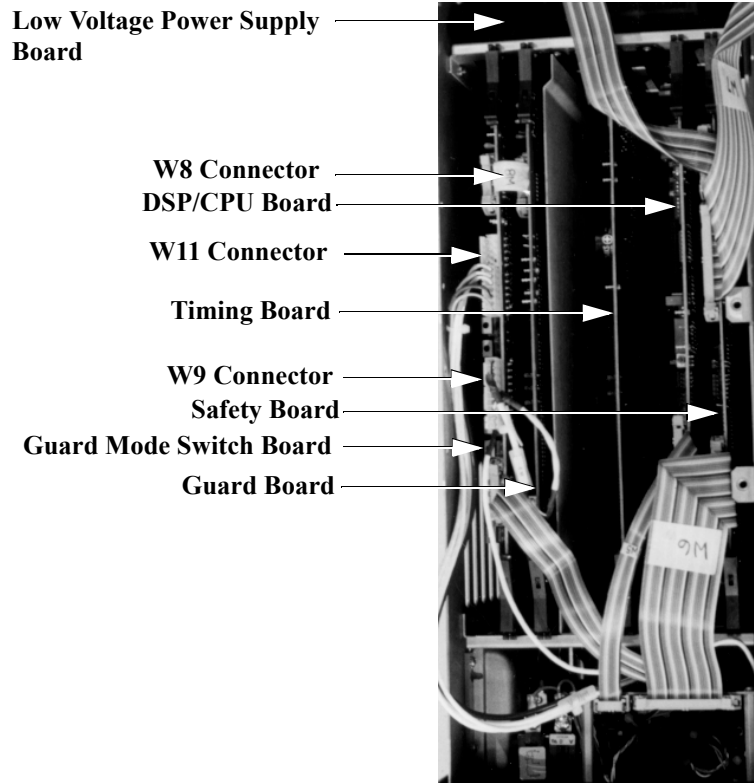
The following precautions significantly reduce the possibility of damaging a board through electrostatic discharge (ESD):

- Before handling a PC board, discharge your body's static charge by wearing a wrist strap or touching a grounded surface.
- Do not remove a replacement board from its anti-static packaging until it is ready to be installed.
- Handle boards by their edges and their extractors (clips). Avoid touching components on the board and any edge connectors that plug into backplane slots.

Take the following steps to remove the card cage cover:

1. Remove the four screws that attach the card cage cover to the left outside wall of the unit using a Phillips head screwdriver.
2. Remove the three screws on the top of the card cage cover using a flat-blade screwdriver.
3. Lift the cover off.

A top view of the card cage appears in Figure 4.24.



*Figure 4.24 M4100 Card Cage*

**NOTE**  
⚠

When replacing boards, the board you need to remove may be underneath a cable attached to another board. If this is the case, release the cable, note where it was connected, and later reconnect it.

## M4100 Internal Checks

Certain internal checks can be performed quite easily, avoiding more complicated measures. Many of these checks can be done with the M4100 unpowered. A few require that AC power be applied with the covers off.

**DANGER**



**If re-application of power is necessary to perform an internal check, follow the procedural instructions carefully to minimize the risk of electrical shock. In particular, make certain that only voltmeter probes come in contact with internal test points. Furthermore, the High Voltage Test Cable and Safety Switch extension must always be disconnected from the Transformer case during internal measurement and inspection.**

## Fan Operation

With AC power applied, the fan typically does not run continuously. Specifically, the fan is supposed to run only when the instrument's internal temperature exceeds 40 C, as measured by a thermostat located on the Heater/Temperature Controller Board.

To check for proper fan operation depress and hold the push-button switch labeled SW2, which is located along the top edge of the DSP/CPU Board (Figure 4.36 on page 4-70). The fan should come on for a few seconds then go off. If the fan fails to come on:

1. First try replacing the DSP/CPU Board by following the procedure in "Replacing the DSP/CPU Board" on page 4-70, then retesting the fan.
2. If the fan still fails to come on when tested, replace the fan by following the procedure in "Replacing the Fan" on page 4-94.

## Low-Voltage Power Checkout

Outputs of the Low Voltage Power Supply Board are readily measured at test points accessible on the Heater/Temperature Controller Board (Figure 4.41 on page 4-80), which is mounted directly on the Low Voltage Power Supply Board. Check the following test points for the specified DC voltages:

TP1	Ground reference
TP2	-5 V
TP3	+15 V
TP4	+5 V (>4.9 V)
TP5	-15 V

If any of the measured voltages is out of range, replace the power supply by following the procedure in "Replacing the Low Voltage Power Supply Board" on page 4-78.

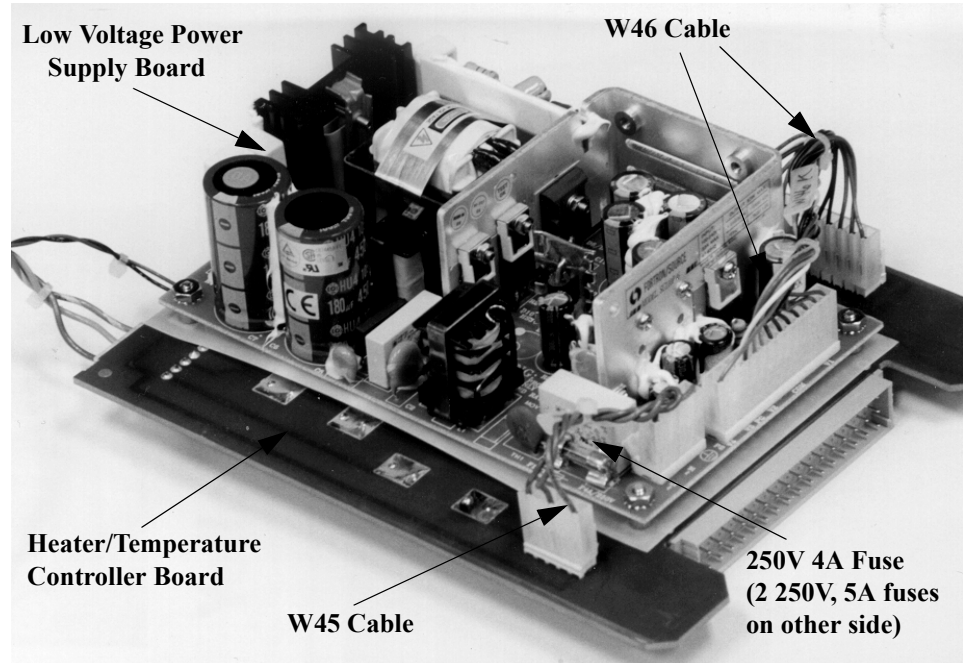
## Guard-to-Ground Shorting Problems

Guard-to-ground shorts can be detected by following the procedure in "Checking M4100 Guard-to-Ground Insulation" on page 4-43. A short is most likely to be found in one of the following areas. Check each possible cause in turn until the source of the problem is isolated:

1. Check the clearance between the Amplifier Assembly and Transformer. They must not be touching at any point. If the instrument has been dropped, the Amplifier Assembly in the bottom of the instrument could have been forced upward into contact with the guard around the Transformer. Eliminate the contact.
2. A screw or other metallic object may have fallen under the guard surrounding the Transformer, thereby shorting the guard to the chassis. Remove the object. This may require removing the Transformer.

## LVPS Fuses

The fuses for the Low Voltage Power Supply Board (LVPS) are located on that board. To access the board, remove the triangular metal plate from the left rear corner of the M4100. The Low Voltage Power Supply Board and Heater/Temperature Board Assembly (Figure 4.25) is then removed after disconnecting the cable from the top of the board.

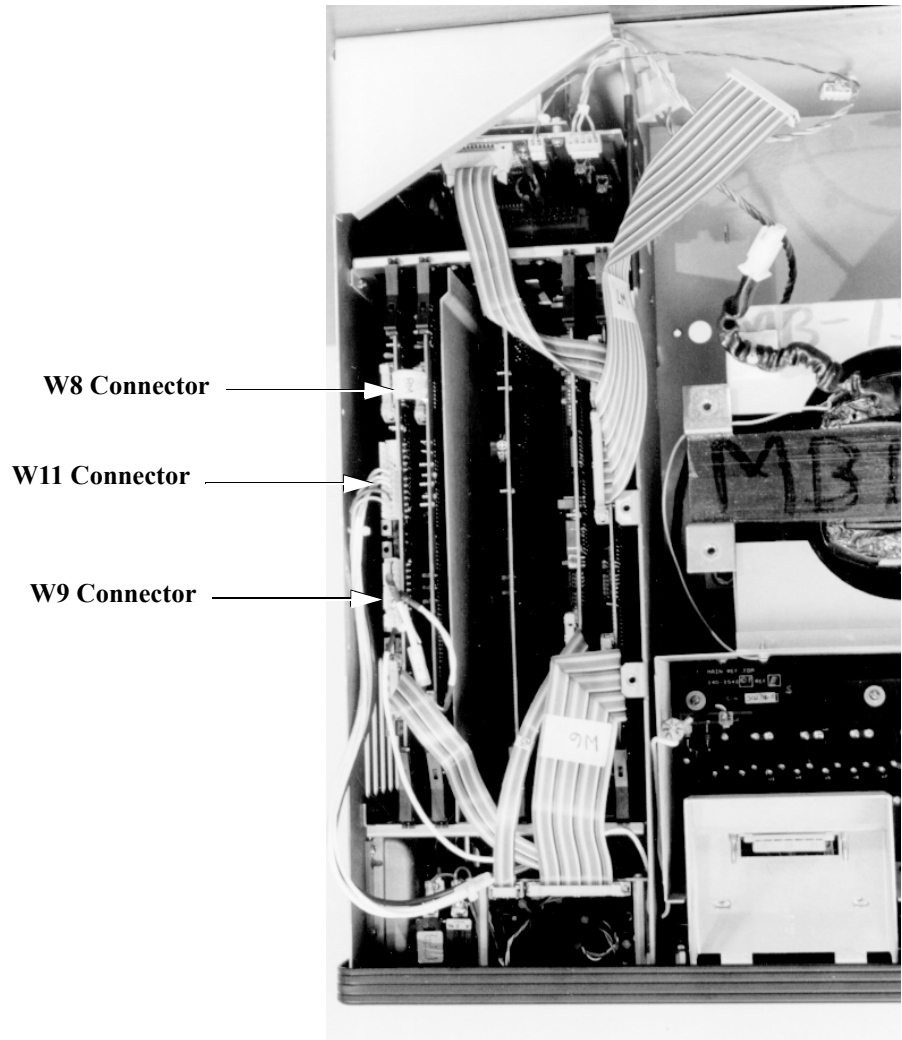


*Figure 4.25 Heater & LVPS Assembly as Removed from 4100*

Check the fuses visually, and if necessary with an Ohmmeter. Replace any fuse that has blown, and monitor system performance for recurrence of the symptom.

## W8/W9/W11 Cable Checkout

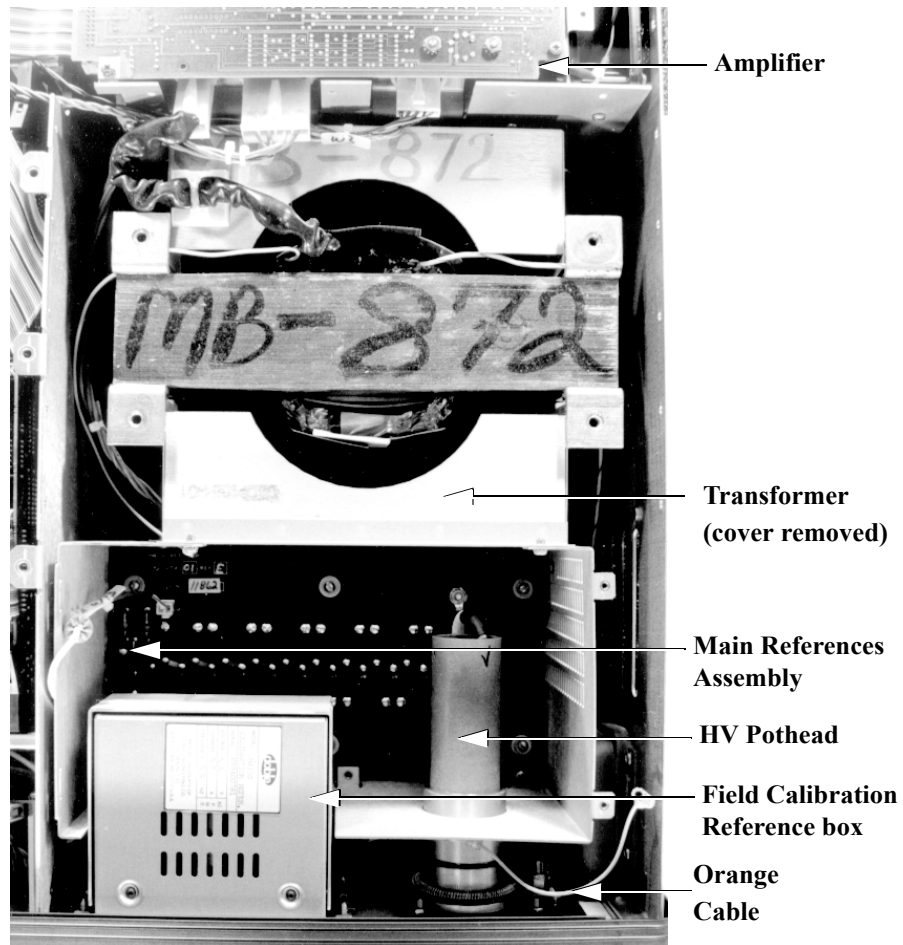
Check and reseal the W8, W9 and W11 cable connectors, which are identified in Figure 4.26.



*Figure 4.26 Card Cage*

## Orange Cable Checkout

Check the Orange Cable (Figure 4.27) for proper seating. It should not be shorting to the chassis, and its insulation should be intact.



*Figure 4.27 M4100 Chassis, Covers Removed*

## Transformer Checks

The metal sheet over the transformer (Figure 4.27) is at chassis ground, while the reference box is at guard potential. The two should not be forced together, making contact with each other, at any point. The transformer beneath the grounded metal cover is also at guard potential. It should not be short-circuited to a grounded point, such as the amplifier box next to it near the bottom of the M4100. An inadvertent short can develop here if the M4100 has been dropped.



## W46 Cable Checkout

The W46 cable is a 12-conductor cable with a white connector on each end. It is located on the Heater/Temperature Controller Board, which is mounted to the Low Voltage Power Supply Board.

Take the following steps to check the W46 cable:

1. Locate and remove the Low Voltage Power Supply Board, referring to "LVPS Fuses" on page 4-52.
2. Disconnect and reseal both connectors on the W46 cable (Figure 4.25 on page 4-52).
3. Replace the Low Voltage Power Supply Board (see "Replacing the Low Voltage Power Supply Board" on page 4-78).

## Replacing M4100 Components

Instructions are provided here for the replacement of M4100 internal, replaceable components for the purpose of diagnosing malfunctions or eliminating problems.

**NOTE**  


**It is important to follow the systematic troubleshooting guidelines in Chapter 4 and elsewhere in Chapter 6 before replacing any M4100 component. Forethought will reduce the difficulty and time required to fix a problem.**

**NOTE**  


**If a replacement component is packaged in an anti-static bag, do not remove it from the bag until instructed to do so. Return all failed components to Doble.**

Replacement of an internal M4100 component requires removal of the instrument's covers and may also require removal of the internal card cage cover. Follow the instructions in "Accessing M4100 Components" on page 4-46 to accomplish these initial steps. That section also includes photographs to assist in identifying each component.

Locate the section that applies to the particular M4100 component to be replaced, then follow its instructions.

**NOTE**  


**Remove any loose screws that may have fallen into the instrument during a replacement procedure.**

**DANGER**



**After successfully replacing any M4100 component, also replace all the covers that were removed prior to operating the instrument. Failure to do so will expose the operator and other persons in the vicinity to lethal voltages, potentially resulting in injury or death from electrocution.**

## Returning Replaced Components

To gain full credit for a replaced component, it must be returned to Doble within 30 days of the replacement component's delivery.

To return a replaced component:

1. Complete the Material Return Tag supplied with the new component. The following entries are *required*:
  - **RWO#**: A Repair Work Order Number assigned to each part by Doble for tracking purposes. If Doble has not entered this number, obtain one by (1) calling Doble Customer Service at (617) 926-4900, extension 317/321/232 or (2) sending an e-mail message to customerservice@doble.com.
  - **Test Set Model**: The unit model number, in this case 4100.
  - **Test Set Serial #**: The unit serial number, which provides warranty information.
  - **Contact Name**: Customer name.
  - **Problem symptoms**.
  - **Contact Tel. #**: Customer telephone number.

If a Material Return Tag was not supplied, please provide the above information separately and include the date and the part number, as well as any observed problems or symptoms and other relevant comments.

2. Attach the Material Return Tag to the old part.
3. Complete the Customer Satisfaction Questionnaire, supplied with the new part, and place it in the box in which the replacement part was shipped.
4. Put the old part in the box and send it to the following address:

**Doble Engineering Company**  
**85 Walnut Street**  
**Watertown, MA 02472**  
**USA**

Doble pays to ship replacement components to customers under warranty, and customers are responsible for payment of shipping costs for returns. For out-of-warranty equipment, customers are responsible for all shipping charges.

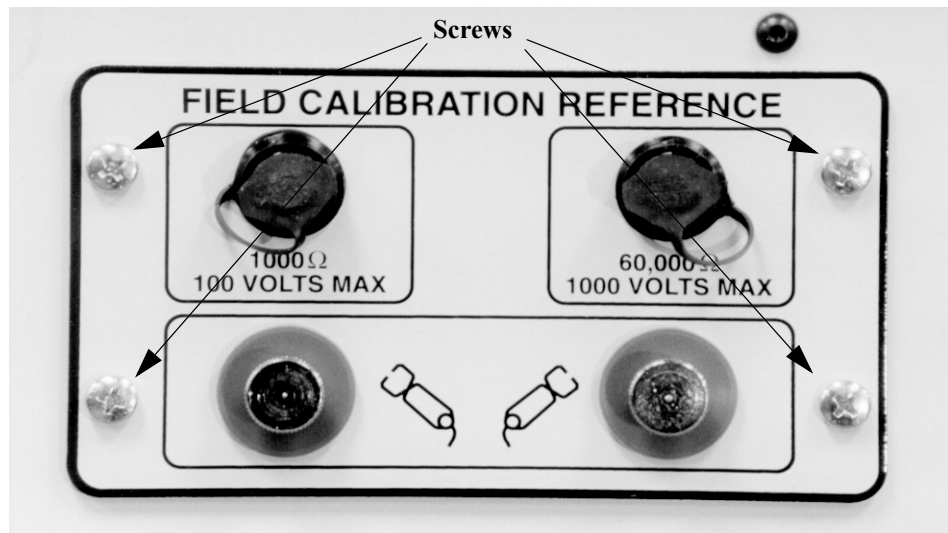
## Removing and Replacing the Front Panel Assembly

The Front Panel Assembly is located on the front of the instrument.

The Front Panel Assembly must be removed in order to replace it and to gain access to the Main Reference Assembly, the Guard Front Panel Board, and the I/O Protection Board. Keep screws that are removed together in a safe location for re-assembly.

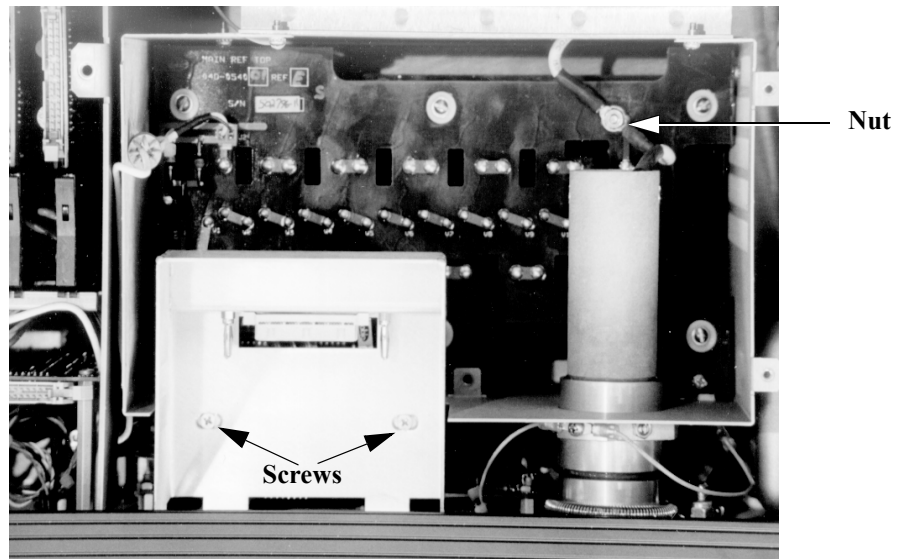
Take the following steps to remove and replace the Front Panel Assembly:

1. Unscrew four captive screws (Figure 4.28) that secure the optional Field Calibration Reference, if present, to the Front Panel Assembly using a Phillips-head screwdriver.



*Figure 4.28 Field Calibration Reference, Screw Locations*

2. Pull out the Field Calibration Reference.
3. Remove the screws (Figure 4.29) on the cover of the Main Reference Assembly using a Phillips-head screwdriver. Then, lift off the cover.
4. Remove two screws inside the box (see Figure 4.29).



*Figure 4.29 Front Panel Removal, Nut Location*

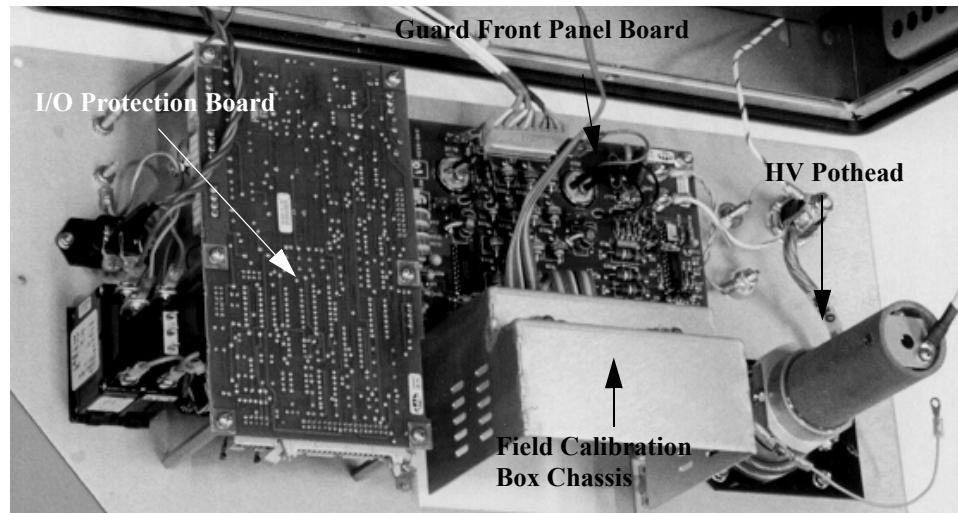
5. Remove one nut located behind the HV Pothead (Figure 4.29), using a nut driver.
6. Remove two screws in the Field Reference Calibration box.
7. Remove the ten self-locking screws that hold the front panel in place using a #8 Torx screwdriver.

**NOTE**

**These screws can be difficult to remove. If any of them binds during extraction, lubricate its front and the rear surfaces with a drop of machine oil. Then, use vise grip pliers to remove the binding screws if necessary. Later, when replacing the front panel, use new screws if available. These can be obtained from Doble if required.**

8. Pull the Front Panel Assembly out only slightly. Then, disconnect the ribbon cable (W12) that attaches to the I/O Protection Board as well as the white cable (W11).
9. Pull the Front Panel Assembly straight out and place it face down on the bench.

The resulting top view of the instrument is as shown in Figure 4.30.



**Figure 4.30** *M4100 Interior View, Front Panel Removed*

- 10.** To reinstall the Front Panel Assembly, first unpack the replacement unit (or locate the existing one). Position it on the front of the instrument. Reconnect the two ribbon cables coming from the I/O Protection Board.
- 11.** Replace the ten self-locking screws that hold the front panel in place using a #8 Torx screwdriver.
- 12.** Replace one nut (Figure 4.29 on page 4-59) located behind the HV Pothead using a nut driver.
- 13.** Replace the Main Reference Assembly cover and secure it by replacing four screws using a Phillips-head screwdriver.
- 14.** Replace the Field Calibration Reference and secure it by tightening four captive screws (Figure 4.28 on page 4-58) using a Phillips-head screwdriver.

## Replacing the Guard Front Panel Board

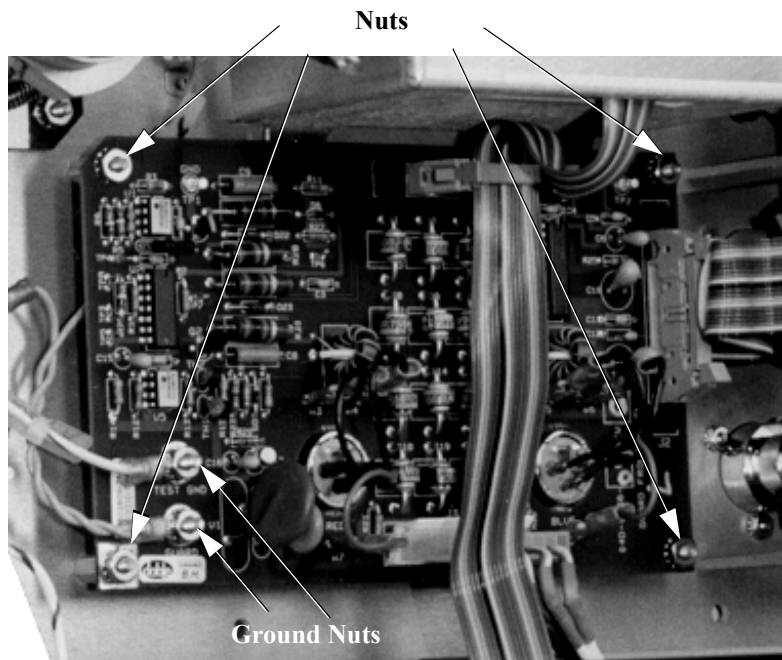
Note the location of the Guard Front Panel Board in Figure 4.30 on page 4-60. It is located immediately behind the Front Panel Assembly. Take the following steps to replace it:

1. If it has not already been done, remove the Front Panel Assembly. See Steps 1-8, "Removing and Replacing the Front Panel Assembly" on page 4-58.

**NOTE**  
⚠

**Do not remove the replacement board from its anti-static bag until instructed to do so. See the Note on page 4-48 for additional ESD precautions.**

2. Remove six #8 nuts (Figure 4.31) that secure the Guard Front Panel Board to the Front Panel Assembly using a 11/32" socket wrench. The nuts are located at the corners of the board.



**Figure 4.31 Guard Front Panel Board, Nut Locations**

3. Remove two #8 nuts (Figure 4.31) that secure the ground connectors to the Guard Front Panel Board. Move the connectors off the board.
4. Disconnect two ribbon cables (W12 and W21).
5. Disconnect two ground wires (one orange and one white/green). Pull the wires straight up to make board removal easier.

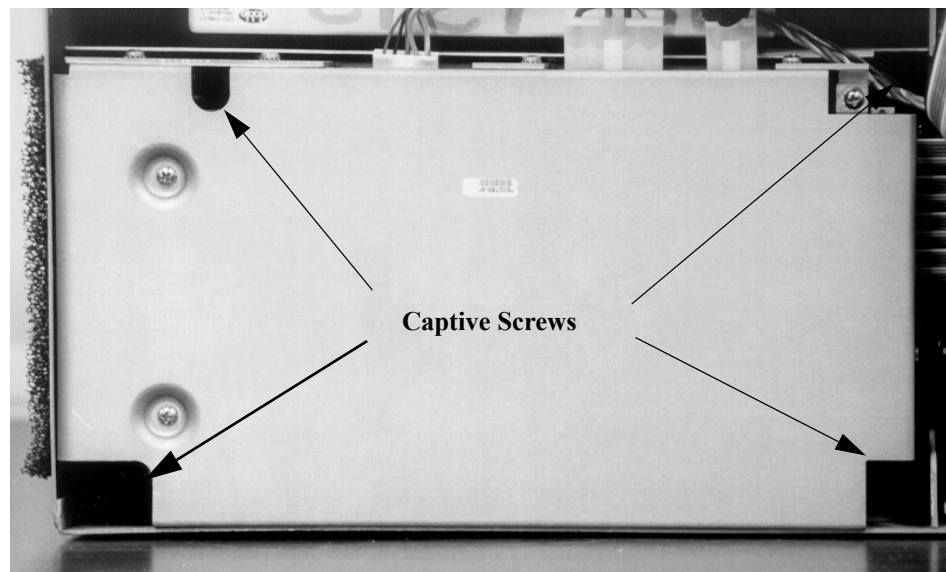
6. Disconnect two connectors on cables W27 and W28. Each connector has three wires; W27 has one red and two black wires; W28 has one blue and two black wires.
7. Carefully lift the Guard Front Panel Board out, easing the wires through the holes.
8. Unpack the replacement Guard Front Panel Board and place the new board into the instrument.
9. Replace four #8 nuts that hold the board in place using a 11/32" socket wrench.
10. Replace two #8 nuts that secure the ground connectors to the Guard Front Panel Board after placing the wires back into position on the board.
11. Connect two connectors on cables W27 and W28. Each connector has three wires; W27 has one red and two black wires; W28 has one blue and two black wires.
12. Connect two ground wires (one orange and one white/green).
13. Connect two ribbon cables (W12 and W21).
14. Replace the Front Panel Assembly by following steps 9-14, "Removing and Replacing the Front Panel Assembly" on page 4-58.
15. Replace the instrument's top and front covers by reversing the steps in "Removing the Front and Top Covers" on page 4-46.



## Replacing the Amplifier Assembly

Note the location of the Amplifier Assembly in Figure 4.23 on page 4-47. Take the following steps to replace it:

1. If it has not already been done, remove the card cage cover. See "Removing the Card Cage Cover" on page 4-48.
2. Remove the Nomex insulator shield to access the four deep-set screws (described in Step 3). The Nomex insulator is a white, flexible board located between the Transformer and the Amplifier Assembly. Grasp a corner of the shield and pull it out using a pair of needle-nose pliers.
3. Insert a 15" flat-blade screwdriver into each of the four notches on top of the Amplifier Assembly to unscrew the four captive screws (Figure 4.32). The four screws attach the Amplifier Assembly to the bottom of the chassis.



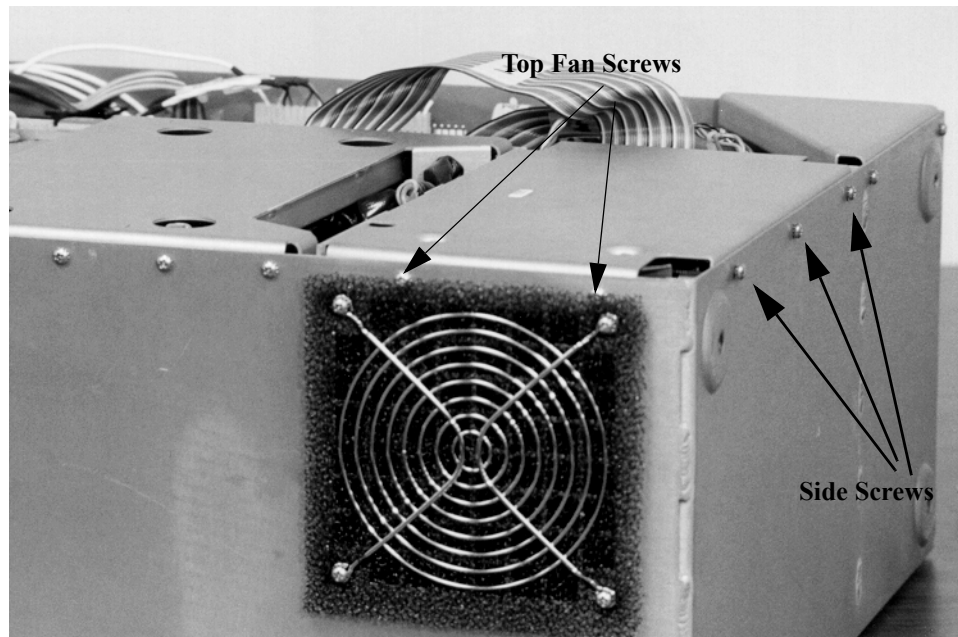
*Figure 4.32 Amplifier Assembly, Captive Screw Locations*

### NOTE



**Do not remove the screws on the top cover of the Amplifier Assembly. That cover need not be removed as part of this procedure.**

4. Remove three screws on the rear panel (Figure 4.33), located between the positions for the top two rubber feet, using a Phillips head screwdriver. (The top two rubber feet were removed to take off the cover.)



*Figure 4.33 Amplifier Assembly, Additional Screw Locations*

5. Remove two Phillips screws (Figure 4.33) holding the top cover of the amplifier and chassis in place using a Phillips-head screwdriver.
6. Disconnect the ribbon cable (W7) from the Guard Board, which is located in the card cage.
7. Release the three white connectors (leading to cables W2, W3 and W4) from the front side of the Amplifier Assembly, closest to the Transformer. Work from right to left, ending with the white connector closest to the card cage.
8. Insert two fingers into the two notches at the top of the Amplifier Assembly to ease it out. Then, grasp the edges of the assembly and carefully lift it out of the instrument.

**NOTE**  
☞

**The clearance around the Amplifier Assembly is only about 1/8 inch. If the assembly is difficult to remove, insert a flat-blade screwdriver around its perimeter to gently pry it out.**

9. Unpack the replacement Amplifier Assembly.
10. Insert two fingers into the notches at the top of the new Amplifier Assembly and gently guide it into position.

11. Tighten one of the captive screws by inserting the 15"-long, flat-blade screwdriver into one of the notches at the top of the assembly, and reach down to tighten the screw. With the first screw in place, use your hands to push the assembly towards the opposite end (away from the screw).
12. Tighten the remaining three captive screws using the 15"-long, flat-blade screwdriver.
13. Replace the three screws on the rear panel using the Phillips head screwdriver.

**NOTE**

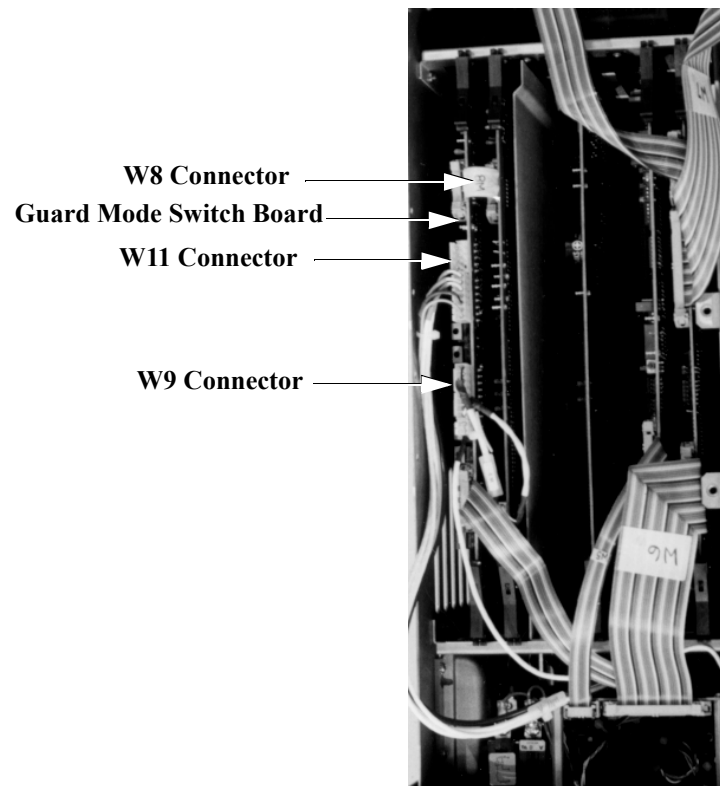
**Since you have already removed two of the screws holding the fan assembly in place, now is a good time to inspect the Fan filter. See "Replacing the Fan Filter" on page 4-93.**

14. Replace the top two screws holding the fan filter in place using the Phillips head screwdriver.
15. Connect the ribbon cable to the Guard Board.
16. Reconnect the three cables to the Amplifier Assembly's white connectors.
17. Replace the Nomex insulator shield.
18. Replace the card cage cover by reversing the steps in "Removing the Card Cage Cover" on page 4-48.
19. Replace the top and front covers by reversing the steps in "Removing the Front and Top Covers" on page 4-46.

## Replacing the Guard Mode Switch Board

Note the location of the Guard Mode Switch Board in Figure 4.24 on page 4-49 and in Figure 4.34 below. Take the following steps to replace it:

1. If it has not already been done, remove the card cage cover. See "Removing the Card Cage Cover" on page 4-48. The Guard Mode Switch Board will be visible as in Figure 4.34.



*Figure 4.34 Guard Mode Switch Board*

**NOTE**  
⚠

**Do not remove the replacement board from its anti-static bag until instructed to do so.**

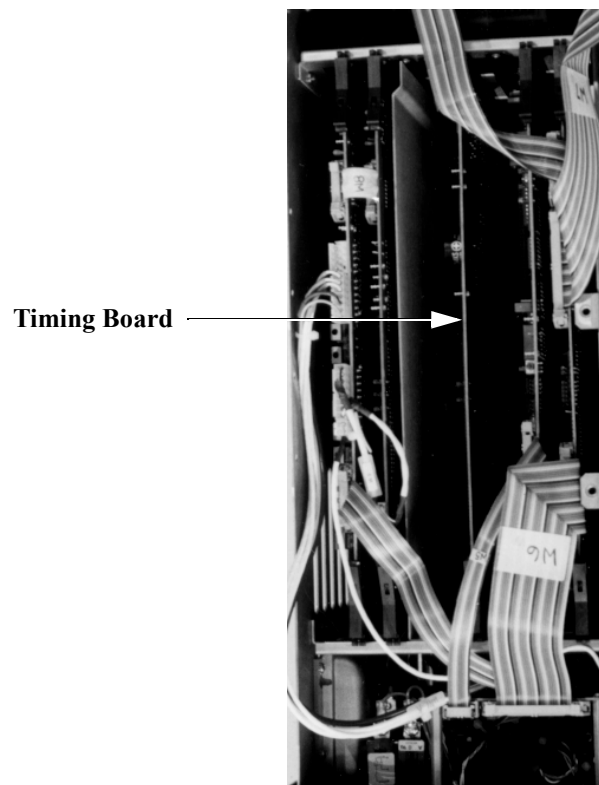
2. Detach the two ribbon cables (W8 and W12) from the board.
3. Detach the four cables (W9, W11, W13, and one unlabeled for future use) from the board.
4. Use your index fingers to unlatch both PC board extractors. Then, pull the board straight up.

5. Remove the replacement Guard Mode Switch Board from its anti-static bag and guide it into the slot. Press down evenly on the insides of the PC extractors until the board is firmly seated.
6. Reattach the two ribbon cables to the board (W8 to J8 and W12 to J5).
7. Reattach the four cables to the board (W9 to J2, W11 to J1, W13 to J3, and the unlabeled cable to J6).
8. Replace the card cage cover by reversing the steps in "Removing the Card Cage Cover" on page 4-48.
9. Replace the top and front covers by reversing the steps in "Removing the Front and Top Covers" on page 4-46.

## Replacing the Timing Board

Note the location of the Timing Board in Figure 4.24 on page 4-49 and in Figure 4.35 below. Take the following steps to replace it:

1. If it has not already been done, remove the card cage cover. See "Removing the Card Cage Cover" on page 4-48. The Timing Board will be visible as in Figure 4.35.



*Figure 4.35 Timing Board*

### NOTE



**Do not remove the replacement board from its anti-static bag until instructed to do so. See the Note on page 4-48 for additional ESD precautions.**

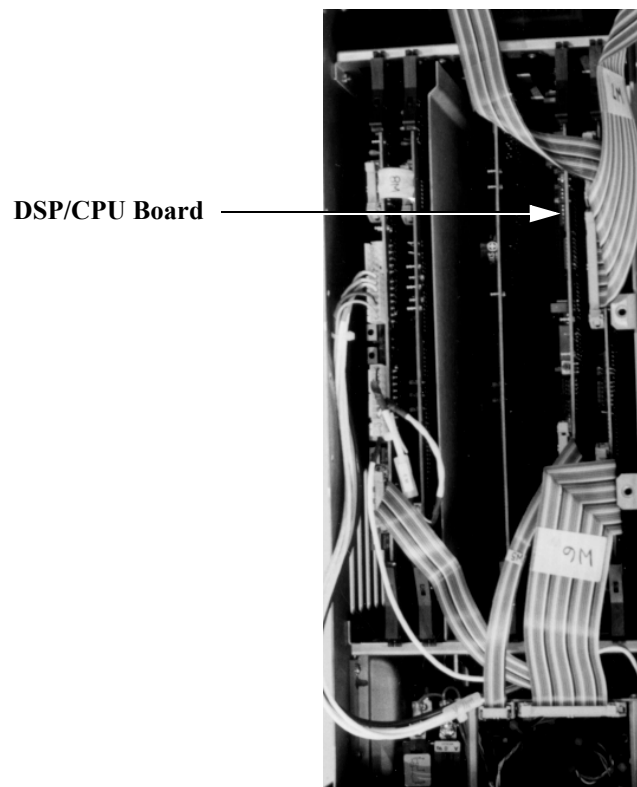
2. Use your index fingers to unlatch both PC board extractors. Then, pull the board straight up.
3. Remove the replacement Timing Board from its anti-static bag and guide it into position. Press down evenly on the insides of the PC extractors until the board is firmly seated.

4. Replace the card cage cover by reversing the steps in "Removing the Card Cage Cover" on page 4-48.
5. Replace the top and front covers by reversing the steps in "Removing the Front and Top Covers" on page 4-46.

## Replacing the DSP/CPU Board

Note the location of the DSP/CPU Board in Figure 4.24 on page 4-49 and in Figure 4.36 below. Take the following steps to replace it:

1. If it has not already been done, remove the card cage cover. See "Removing the Card Cage Cover" on page 4-48. The DSP CPU Board will be visible as in Figure 4.36.



*Figure 4.36 DSP/CPU Board*

**NOTE**  
⚡

**Do not remove the replacement board from its anti-static bag until instructed to do so. See the Note on page 4-48 for additional ESD precautions.**

2. Detach the ribbon cable (W5) from the board.
3. Use your index fingers to unlatch both PC board extractors. Then, pull the board straight up.
4. Remove the replacement DSP/CPU Board from its anti-static bag and guide it into the slot. Press down evenly on the insides of the PC extractors until the board is firmly seated.

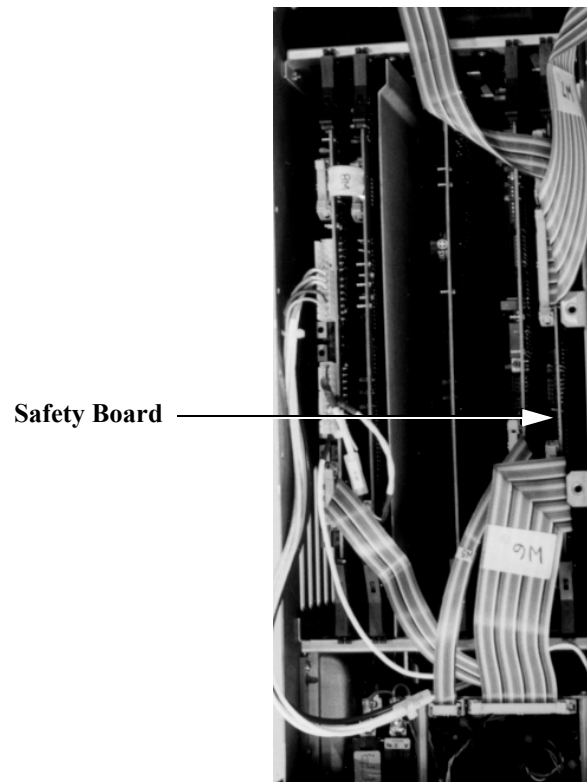


5. Reattach the ribbon cable (W5) to the board.
6. Replace the card cage cover by reversing the steps in "Removing the Card Cage Cover" on page 4-48.
7. Replace the top and front covers by reversing the steps in "Removing the Front and Top Covers" on page 4-46.

## Replacing the Safety Board

Note the location of the Safety Board in Figure 4.24 on page 4-49 and in Figure 4.37 below. Take the following steps to replace it:

1. If it has not already been done, remove the card cage cover. See "Removing the Card Cage Cover" on page 4-48. The Safety Board will be visible as in Figure 4.37.



*Figure 4.37 Safety Board*

**NOTE**  
⚠

**Do not remove the replacement board from its anti-static bag until instructed to do so. See the Note on page 4-48 for additional ESD precautions.**

2. Detach the three ribbon cables (W4, W6 and W7) from the board.
3. Use your index fingers to unlatch both PC board extractors. Then, pull the board straight up.
4. Remove the replacement Safety Board from its anti-static bag and guide it into the slot. Press down evenly on the insides of the PC extractors until the board is firmly seated.

5. Reattach the three ribbon cables to the board (W4 to J1, W6 to J3, and W7 to J2).
6. Replace the card cage cover by reversing the steps in "Removing the Card Cage Cover" on page 4-48.
7. Replace the top and front covers by reversing the steps in "Removing the Front and Top Covers" on page 4-46.

## Replacing the Main Reference Assembly

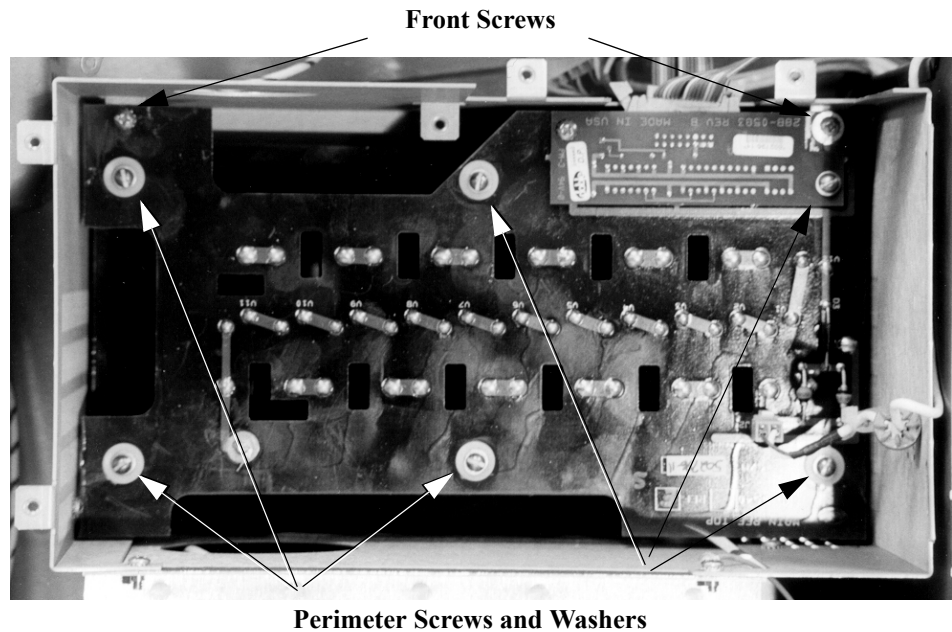
Note the location of the Main Reference Assembly in Figure 4.30 on page 4-60. Take the following steps to replace it:

1. If it has not already been done, remove the Front Panel Assembly. See Steps 1-8, "Removing and Replacing the Front Panel Assembly" on page 4-58. (The Front Panel Assembly must be removed to replace the Main Reference Assembly, but the two assemblies are not attached.)

**NOTE**  
⚡

**Do not remove the replacement board from its anti-static bag until instructed to do so. See the Note on page 4-48 for additional ESD precautions.**

2. Remove the cover of the Main Reference Assembly. Do this by removing the two screws using a Phillips-head screwdriver.  
Removing one screw releases an orange cable.
3. Disconnect the W12 ribbon cable.
4. Remove two screws, one in each front corner of the Main Reference Assembly (Figure 4.38), using a Phillips-head screwdriver. Some older units have three screws to be removed.



*Figure 4.38 Main Reference Assembly, Screw Locations*

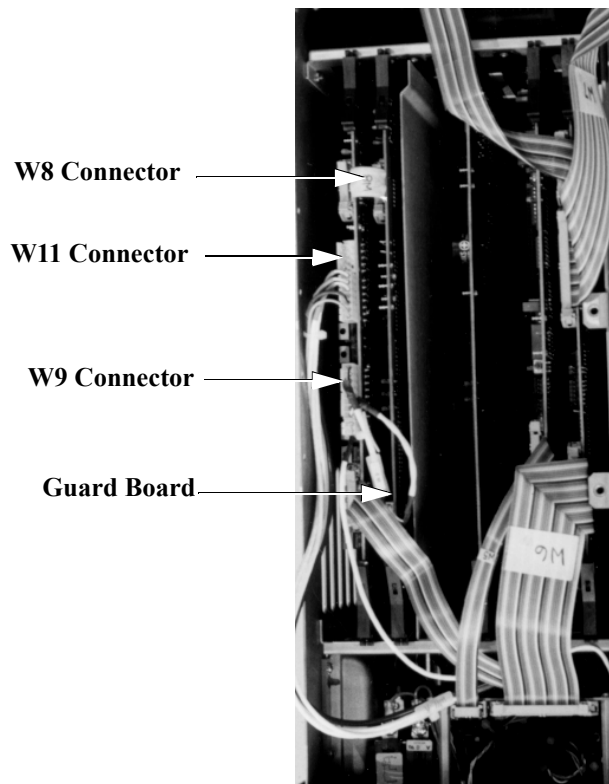
5. Remove six screws, along with internal lock washers and flat washers, using a flat-blade screwdriver. These screws are located on the perimeter of the board (Figure 4.38).
6. With your fingers on the edges of the board, lift the board slightly, tilt it back, then lift it straight up and out. (Tilting the board avoids contact with screws inside the Main Reference Assembly).
7. Remove the replacement Main Reference Assembly from its anti-static bag and, with your fingers on the edge of the board, place it in the instrument by reversing the process in Step 6. Tilt the board initially to avoid contact with any screws, then turn it and place it flat on the bottom of the assembly.
8. Replace six screws, with internal lock washers and flat washers, using a flat-blade screwdriver. These screws are located on the perimeter of the board.
9. Replace the screws (two or three depending on your instrument), one in each front corner of the Main Reference Assembly, using a Phillips-head screwdriver.
10. Connect the W12 ribbon cable.
11. Replace the cover of the Main Reference Assembly by replacing the two screws using a Phillips-head screwdriver.

Notice that there is a blue grommet attached to the cable that connects to the Guard Mode Switch Board. When replacing the screw that secures this cable, set the blue grommet into the notch on the Main Reference Assembly cover.
12. Replace the Front Panel Assembly by following steps 9-14, "Removing and Replacing the Front Panel Assembly" on page 4-58.
13. Replace the top and front covers by reversing the steps in "Removing the Front and Top Covers" on page 4-46.

## Replacing the Guard Board

Note the location of the Guard Board in Figure 4.24 on page 4-49 and in Figure 4.39 below. Take the following steps to replace it:

1. If it has not already been done, remove the card cage cover. See "Removing the Card Cage Cover" on page 4-48. The Guard Board will be visible as in Figure 4.39.



*Figure 4.39 Guard Board*

**NOTE**



**Do not remove the replacement board from its anti-static bag until instructed to do so. See the Note on page 4-48 for additional ESD precautions.**

2. Detach the ribbon cable (W8) from the board.
3. Detach the two connectors on cable W9 from the board.
4. Use your index fingers to unlatch both PC board extractors. Then, pull the board straight up.

5. Remove the replacement Guard Board from its anti-static bag and guide it into the slot. Press down evenly on the insides of the PC extractors until the board is firmly seated.
6. Reattach the two connectors to the board (W9 to J2 and W9 to J3).
7. Reattach the ribbon cable to the board (W8 to J1).
8. Replace the card cage cover by reversing the steps in "Removing the Card Cage Cover" on page 4-48.
9. Replace the top and front covers by reversing the steps in "Removing the Front and Top Covers" on page 4-46.

## Replacing the Low Voltage Power Supply Board

Note the location of the Low Voltage Power Supply Board in Figure 4.23 on page 4-47.

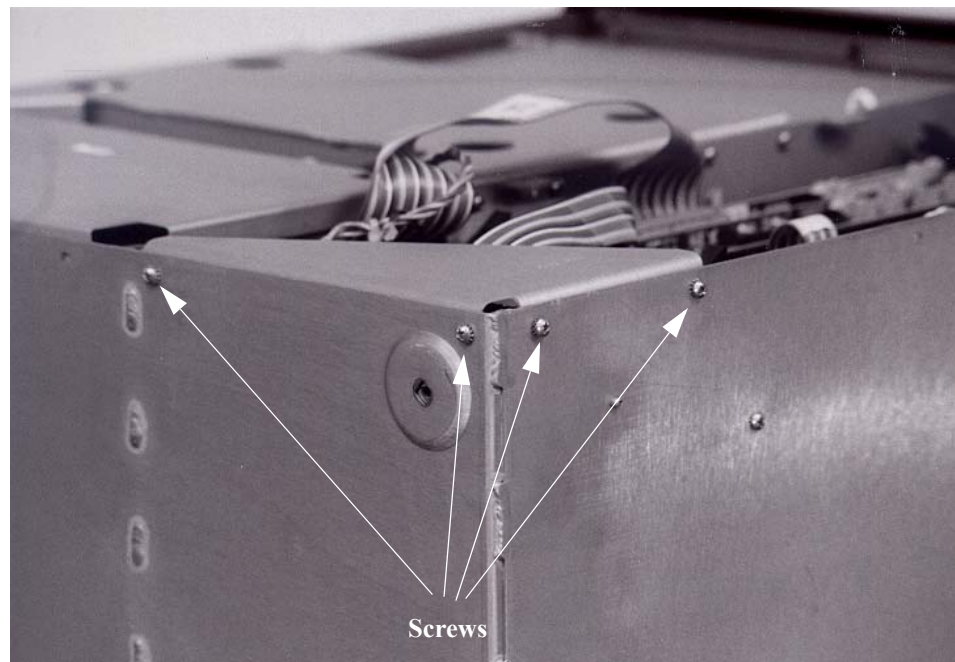
Take the following steps to replace it:

**NOTE**



**Do not remove the replacement board from its anti-static bag until instructed to do so. See the Note on page 4-48 for additional ESD precautions.**

1. Remove four screws (Figure 4.40) using a Phillips-head screwdriver. Two screws secure the corner brace to the rear panel of the Instrument and two screws secure the brace to the side panel.



*Figure 4.40 Low Voltage Power Supply Board, Screw Locations*

2. Lift off the corner brace to access the board.
3. Remove the white Nomex insulator shield located between the Low Voltage Power Supply Board and the chassis. Simply grasp it and pull it out.
4. If necessary, move the ribbon cables out of the way to allow access.
5. Release the two connectors on cables W3 and W4 leading from the Amplifier Assembly.



6. Lift the board out.
7. Remove the replacement Low Voltage Power Supply Board from its anti-static bag and place it in the Instrument.
8. Reconnect the two cables and reposition any other cables previously moved as necessary.
9. Replace the Nomex insulator shield.
10. Place the corner brace back into position and replace the four screws to secure the brace using a Phillips head screwdriver.
11. Replace the top and front covers by reversing the steps in "Removing the Front and Top Covers" on page 4-46.

## Replacing the Heater/Temperature Controller Board

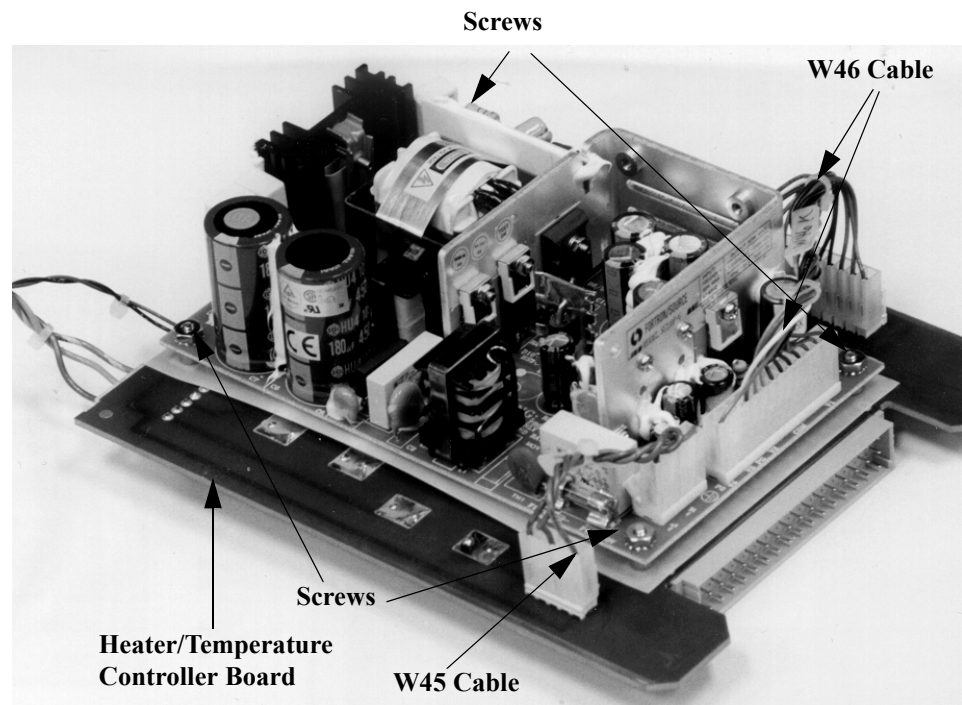
The Heater/Temperature Controller Board is the green board attached to the Low Voltage Power Supply Board. Before replacing the Heater/Temperature Controller Board, you must first remove the entire, two-board assembly from the instrument.

Take the following steps to replace the Heater/Temperature Controller Board:

**NOTE**  
⚠

**Do not remove the replacement board from its anti-static bag until instructed to do so. See the Note on page 4-48 for additional ESD precautions.**

1. Remove the Low Voltage Power Supply Board from the Instrument by following Steps 1-6 in "Replacing the Low Voltage Power Supply Board" on page 4-78.
2. Remove the four screws that attach the Heater/Temperature Controller Board to the Low Voltage Power Supply Board (Figure 4.41) using a Phillips-head screwdriver. This will also release the four spacers.



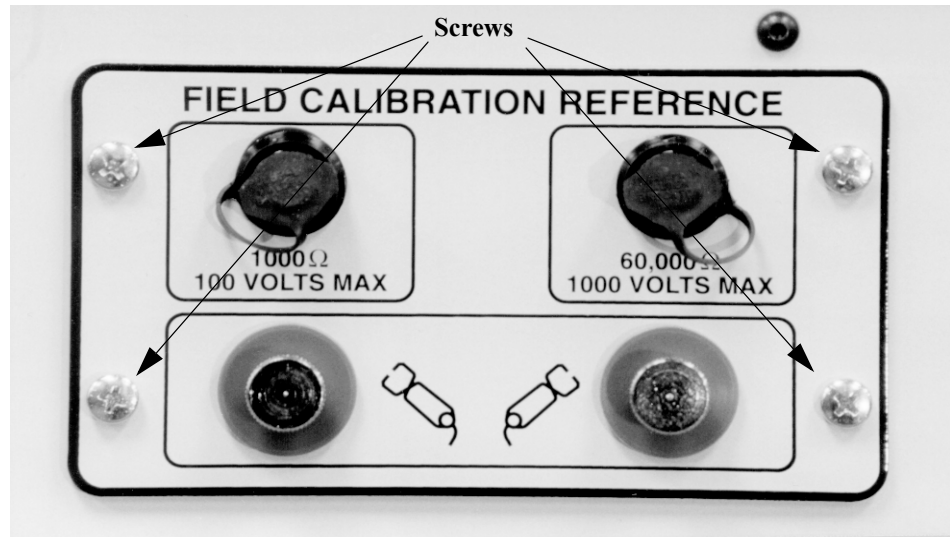
*Figure 4.41 Heater & Low Voltage Power Supply Assembly, Screw Locations*

3. Release the two connectors leading to cables W45 and W46.
4. Remove the new Heater/Temperature Controller Board from its anti-static bag and position it onto the Low Voltage Power Supply Board. Place a spacer between the two components at each screw position.
5. Reconnect the two connectors.
6. Replace the four screws that join the components together using a Phillips-head screwdriver.
7. Re-install the Low Voltage Power Supply Board into the instrument by following Steps 8-11 in "Replacing the Low Voltage Power Supply Board" on page 4-78.

## Replacing the Optional Field Calibration Reference

The Field Calibration Reference, if present, is mounted to the instrument's front panel. Take the following steps to replace it:

1. Unscrew four captive screws (Figure 4.42) using a Phillips-head screwdriver.



*Figure 4.42 Field Calibration Reference, Screw Locations*

2. Pull out the Field Calibration Reference.
3. Unpack the replacement Field Calibration Reference and place it in position in the front panel.
4. Tighten the four captive screws using a Phillips-head screwdriver.
5. Replace the top and front covers by reversing the steps in "Removing the Front and Top Covers" on page 4-46.

## Replacing the I/O Protection Board

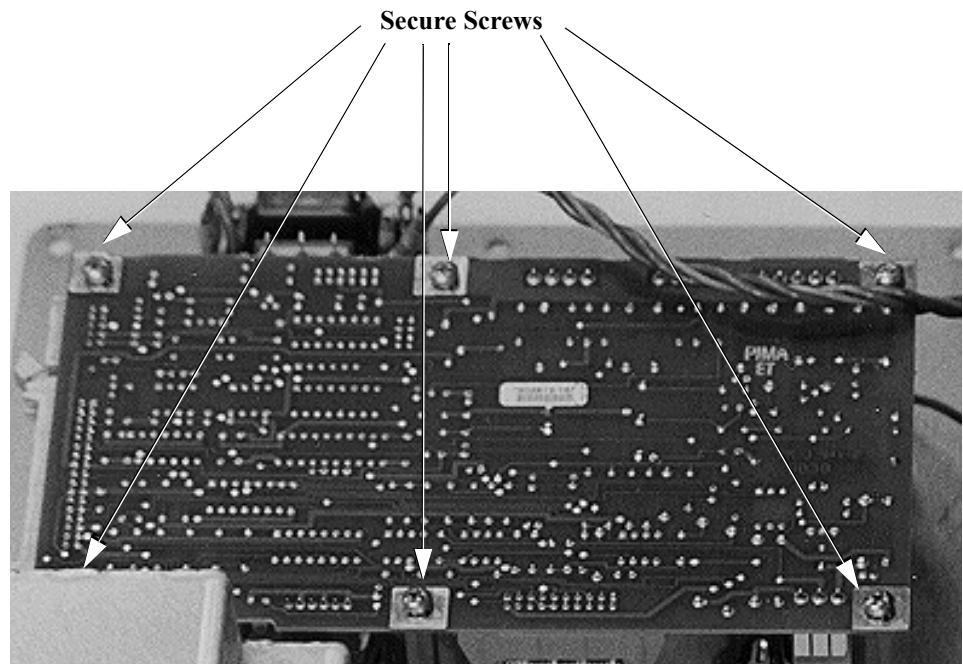
Note the location of the I/O Protection Board in Figure 4.30 on page 4-60. Take the following steps to replace it:

1. If it has not already been done, remove the Front Panel Assembly. See Steps 1-8, "Removing and Replacing the Front Panel Assembly" on page 4-58. Place the Front Panel Assembly face down on the bench.

**NOTE**  
⚠

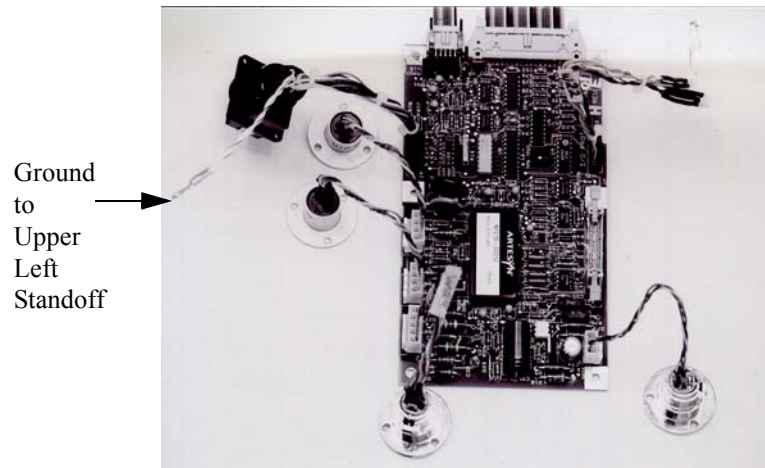
**Do not remove the replacement board from its anti-static bag until instructed to do so. See the Note on page 4-48 for additional ESD precautions.**

2. Remove six screws (Figure 4.43) that attach the I/O Protection Board to the Front Panel Assembly using a Phillips-head screwdriver. Note that one of the screws also secures a black and white grounding wire.



*Figure 4.43 I/O Protection Board, Screw Locations*

3. Release one W21 and two W24 ribbon cables. Since these last two cables are both labeled "W24", note their connection points so that they can be correctly re-connected once the board has been replaced.
4. Release connections to four cables (W22, W23, W25 and W26).



**Figure 4.44** *I/O Protection Board, Cable Connections*

5. Carefully lift the I/O Protection Board off the Front Panel Assembly.
6. Unpack the replacement I/O Protection Board from its anti-static bag and place the new board onto the Front Panel Assembly.
7. Replace six screws that attach the I/O Protection Board to the Front Panel Assembly using a Phillips-head screwdriver.
  - First replace the two middle screws (rather than the screws located in the corners) to tack the board in place.
  - Before replacing the screw that secures the grounding wire, first insert the black and white wire between the I/O Protection Board and the standoff. Then, tighten the screw.
8. Reconnect one W21 and two W24 ribbon cables. The W24 cable located closest to the Field Calibration Reference connects to J2. The other W24 cable, located furthest away from the Field Calibration Reference, connects to J3.
9. Reconnect four cables as follows:
  - W22 to J7
  - W23 to J9
  - W25 to J1
  - W26 to J4
10. Replace the Front Panel Assembly by following steps 9-14, "Removing and Replacing the Front Panel Assembly" on page 4-58.
11. Replace the top and front covers by reversing the steps in "Removing the Front and Top Covers" on page 4-46.

## Replacing the Transformer

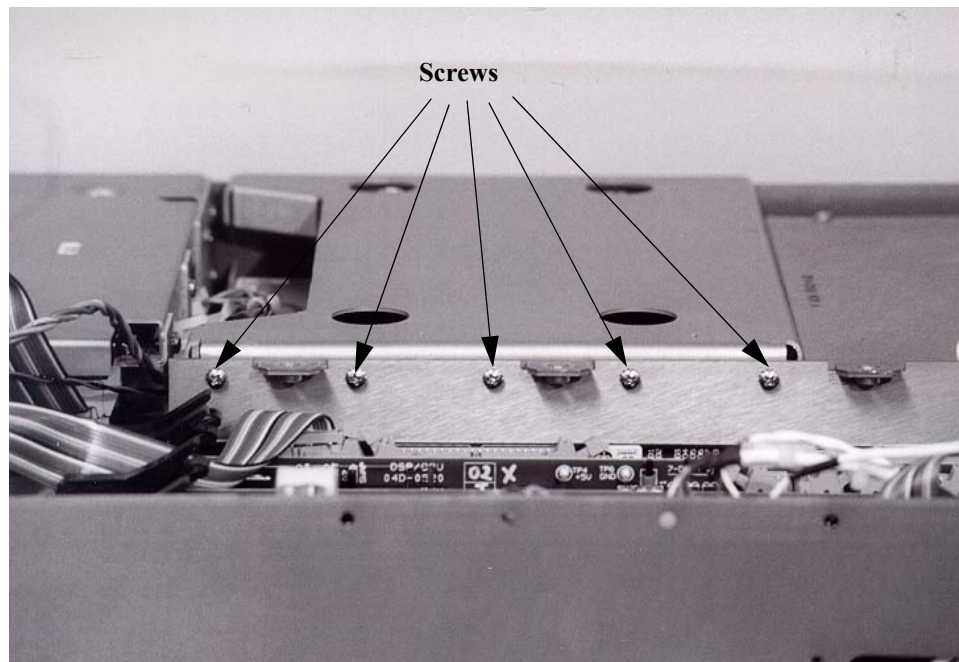
Note the location of the Transformer in Figure 4.23 on page 4-47.

**NOTE**  


**Due to the vibration the instrument encounters in the field, Doble now recommends replacing the originally installed whiz nuts with elastic stop nuts. When replacing the Transformer, check to see if it is mounted using whiz nuts. If so, mount the replacement Transformer with the more reliable elastic stop nuts.**

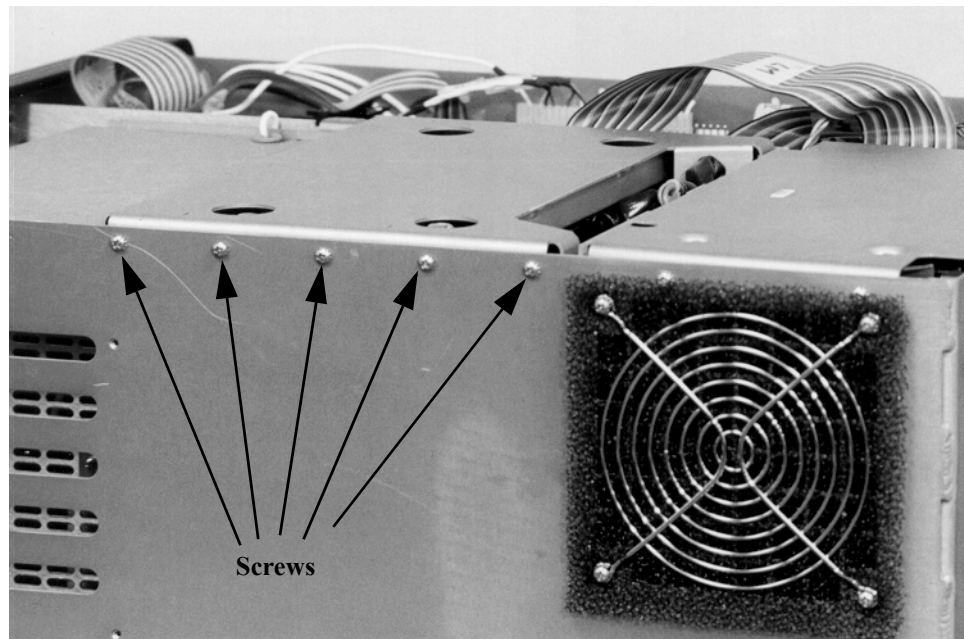
Take the following steps to replace the Transformer:

1. If it has not already been done, remove the card cage cover. See "Removing the Card Cage Cover" on page 4-48. The Transformer cover will be visible as in Figure 4.45.
2. Remove the Transformer cover, being careful not to drop any screws inside the unit.
  - Remove five screws (Figure 4.45) using a 15" Phillips-head screwdriver. These screws are located inside the card cage, near the top, where the card cage is attached to the Transformer cover.



*Figure 4.45 Transformer Cover, Screw Locations on Card Cage*

- Remove five screws (Figure 4.46), located on the outside of the instrument next to the fan, using a Phillips-head screwdriver.



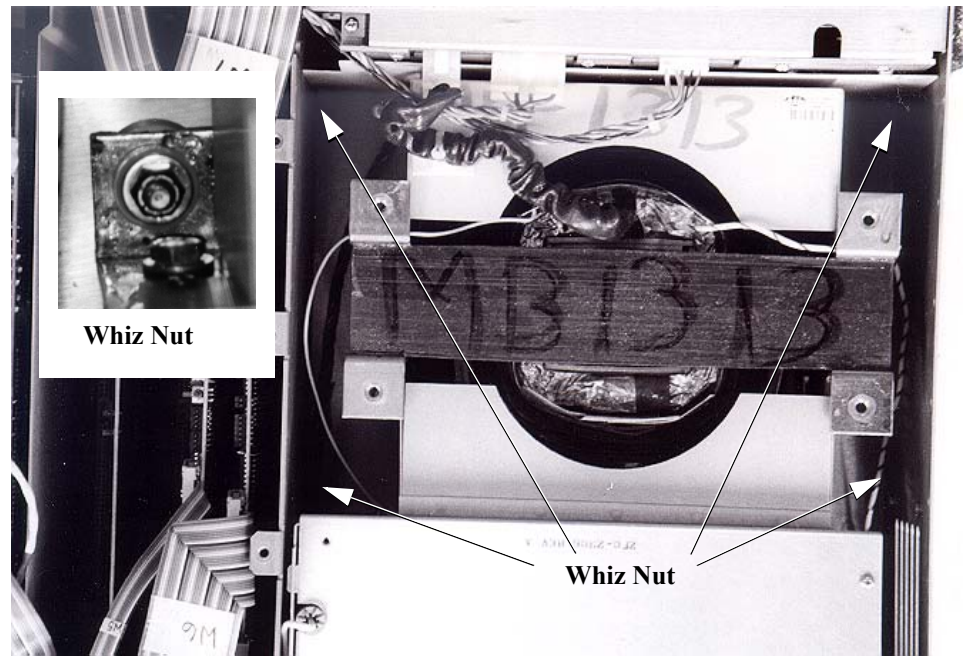
***Figure 4.46 Transformer Cover, Screw Locations on Side Panel***

- Remove four screws and washers, located on the top of the Transformer cover, using a flat-blade screwdriver
- Lift the cover off. White grommets will come off with the cover. Keep all screws, washers, and grommets together in a safe place.

Figure 4.27 on page 4-54 shows the instrument with the Transformer cover removed.

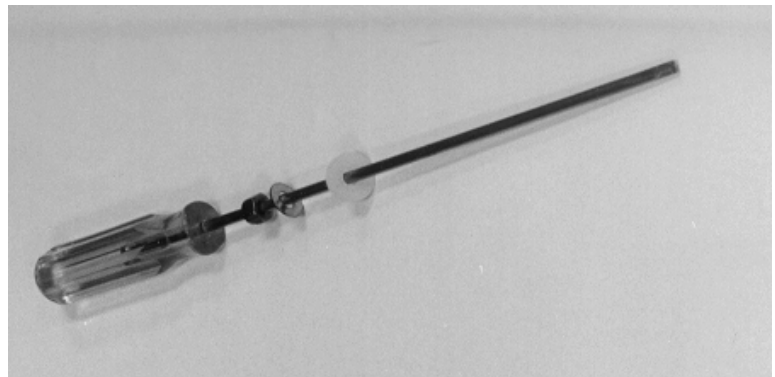
3. Replace the whiz nuts with elastic stop nuts if necessary. Otherwise, proceed to Step 4.
  - Remove the four whiz nuts located at the corners of the Transformer where it attaches to the bottom of the chassis (Figure 4.47). Do this by inserting a 7/16" socket wrench into each corner of the Transformer and reaching all the way down to loosen and remove the nuts.





**Figure 4.47 Transformer Mounting Nut Locations**

- Place the elastic stop nuts into position using a 15” screwdriver as a guide. Place a nylon washer, a metal washer, and then the elastic stop nut on the screwdriver (Figure 4.48). Hold these pieces in place while inserting the screwdriver into each corner of the Transformer Assembly (Figure 4.49), then release the washers and nuts.



**Figure 4.48 Preparing The Screwdriver**

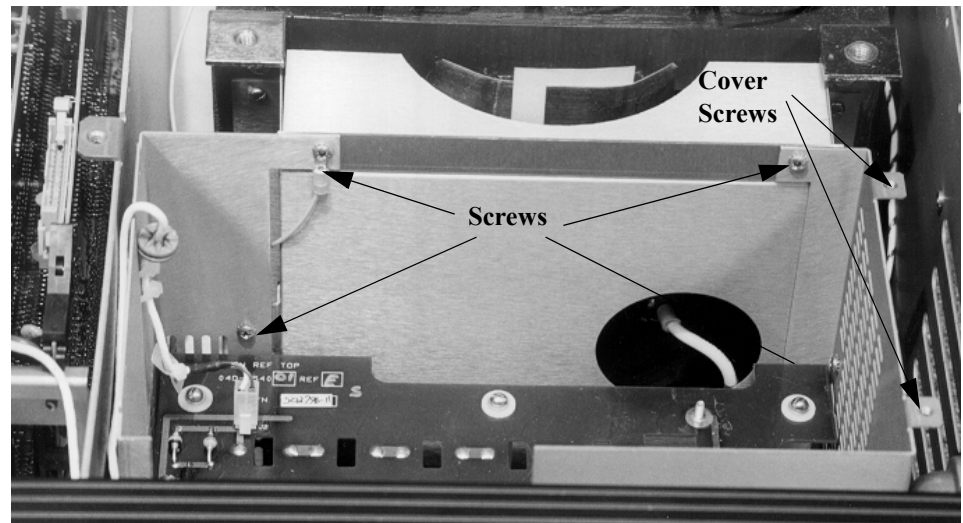


**Figure 4.49 Guiding the Transformer Mounting Nuts into Position**

- Use the 7/16" socket wrench to tighten the nuts. Do not overtighten them.
4. Remove the cover of the Main Reference Assembly. Do this by removing the two screws (Figure 4.50) using a Phillips-head screwdriver.

Figure 4.27 on page 4-54 shows the instrument with the Main Reference Assembly cover removed.

- Remove the four screws (Figure 4.50), where the Main Reference Assembly joins the chassis, using a Phillips-head screwdriver.



*Figure 4.50 Main Reference Assembly, Screw Locations*

5. Release the three connectors on cables W2, W3 and W4 (which lead to the Amplifier Assembly) by grasping them and pulling the cables away from the Transformer. Move other cables out of the way as necessary to clear a path for lifting out the Transformer.
6. Remove the Nomex insulator shield located between the Transformer and the Amplifier Assembly. Simply grasp the shield and pull it out.
7. With two people, one on each side, lift the Transformer straight up and remove it from the Instrument.

**WARNING**



**The Transformer is heavy. Two persons are required to safely lift it out of the instrument. This step is best accomplished with the M4100 relocated to the floor.**

8. Unpack the new Transformer. Again using two people, place the new Transformer into position in the instrument.
9. Replace the Nomex insulator shield by sliding it in between the Transformer and the Amplifier Assembly.
10. Reconnect the three cables.
11. Replace the four screws, near where the Main Reference Assembly attaches to the Transformer, using a Phillips-head screwdriver.

- 12.** Replace the cover of the Main Reference Assembly and secure it by replacing the screws using a Phillips-head screwdriver.

Notice that there is a blue grommet attached to the cable that connects to the Guard Mode Switch Board. When replacing the screw that secures this cable, set the blue grommet into the notch on the Main Reference Assembly cover.

- 13.** Replace the Transformer cover and white grommets.

- Replace the five screws near the top, inside edge of the card cage using a 15" Phillips-head screwdriver.
- Replace the five screws on the outside of the instrument next to the fan using a Phillips-head screwdriver.
- Replace four screws and washers on the top of the Transformer cover using a flat-blade screwdriver.

- 14.** Replace the card cage cover by reversing the steps in "Removing the Card Cage Cover" on page 4-48.

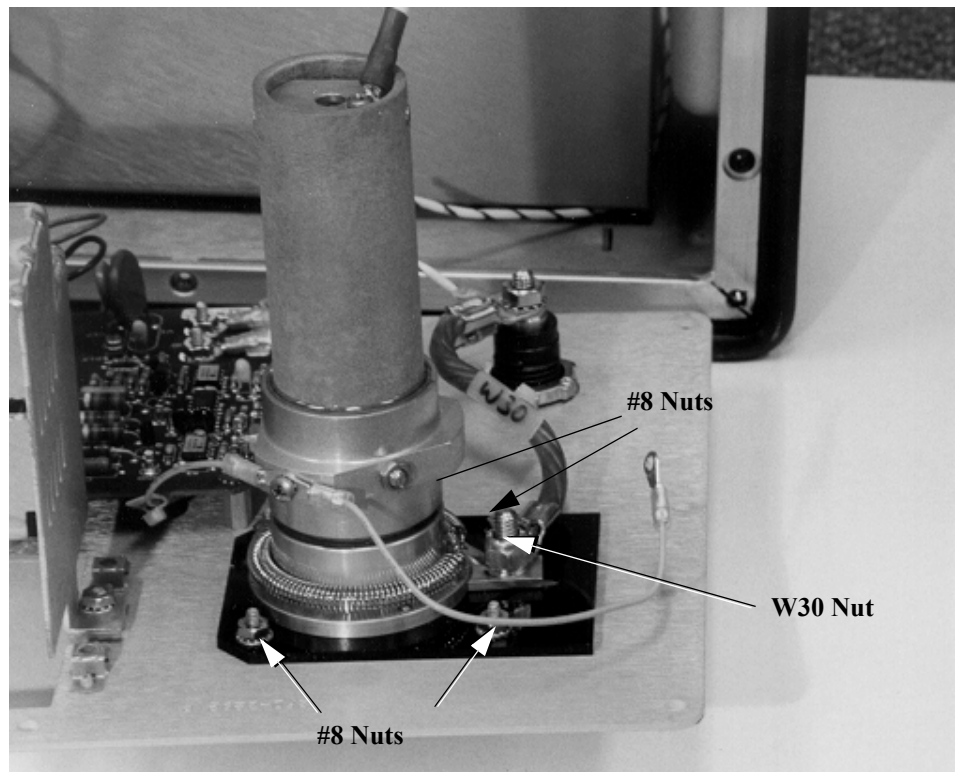
- 15.** Replace the top and front covers by reversing the steps in "Removing the Front and Top Covers" on page 4-46.

- 16.** Check for Guard-to-Ground Insulation, as described in "Checking M4100 Guard-to-Ground Insulation" on page 4-43.

## Replacing the HV Pothead

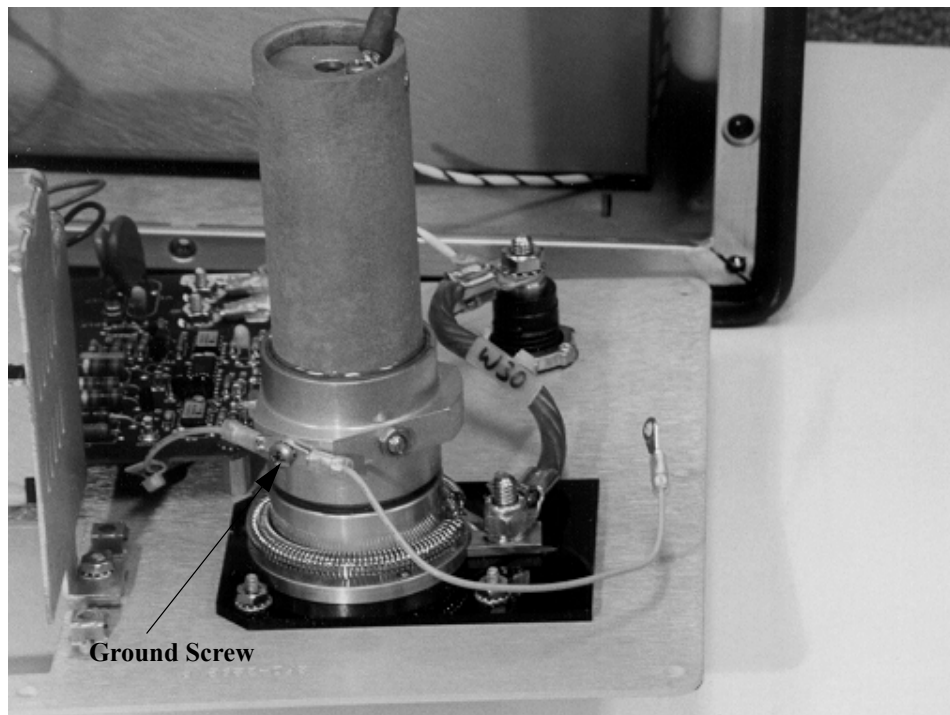
Note the location of the HV Pothead in Figure 4.30 on page 4-60. Take the following steps to replace it:

1. If it has not already been done, remove the Front Panel Assembly. See Steps 1-8, "Removing and Replacing the Front Panel Assembly" on page 4-58. Place the Front Panel Assembly face down on the bench.
2. Remove one 1/4" elastic nut (Figure 4.51), on the back of the Front Panel Assembly to release the W30 cable, using a socket wrench.



*Figure 4.51 HV Pothead, W30 Screw and Nut Locations*

3. Remove four #632 nuts with flat washers (Figure 4.51), found in the corners of the black plate beneath the HV Pothead, using an 11/32" socket wrench.



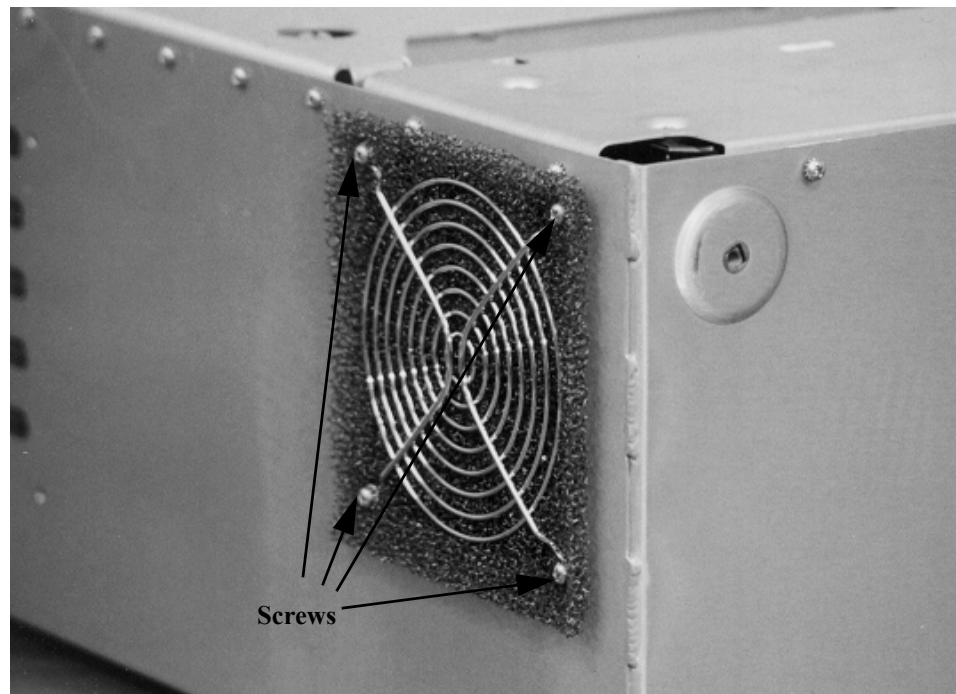
*Figure 4.52 HV Pothead, Ground Screw Location*

4. Remove one screw and washer (Figure 4.52), that secure the ground wire and the power outlet wire to the side of the HV Pothead, using a Phillips-head screwdriver.
5. Carefully lift the HV Pothead out.
6. Unpack the replacement HV Pothead and place it onto the Front Panel Assembly.
7. Replace four #632 nuts with flat washers, into the corners of the black plate beneath the HV Pothead, using an 11/32" socket wrench.
8. Grasp the ground wire and the power outlet wire (Figure 4.52) and place them back onto the side of the HV Pothead. Secure these wires by replacing the screw and washer using a Phillips-head screwdriver.
9. Replace the 1/4" elastic nut, on the back of the Front Panel Assembly to secure the W30 cable, using a socket wrench.
10. Replace the Front Panel Assembly by following steps 9-14, "Removing and Replacing the Front Panel Assembly" on page 4-58.
11. Replace the top and front covers by reversing the steps in "Removing the Front and Top Covers" on page 4-46.

## Replacing the Fan Filter

Note the location of the fan filter in Figure 4.53. Inspect the filter from time to time to check for accumulated dust or scale. Take the following steps to replace it:

1. Remove the four screws that hold the fan's grill in place (Figure 4.53) using a Phillips-head screwdriver.



*Figure 4.53 Fan Filter Screw Locations*

2. Remove the old fan filter and replace it with a new one.
3. Replace the four screws using a Phillips-head screwdriver. Use the screwdriver to tuck the new filter in place, if necessary.

### NOTE

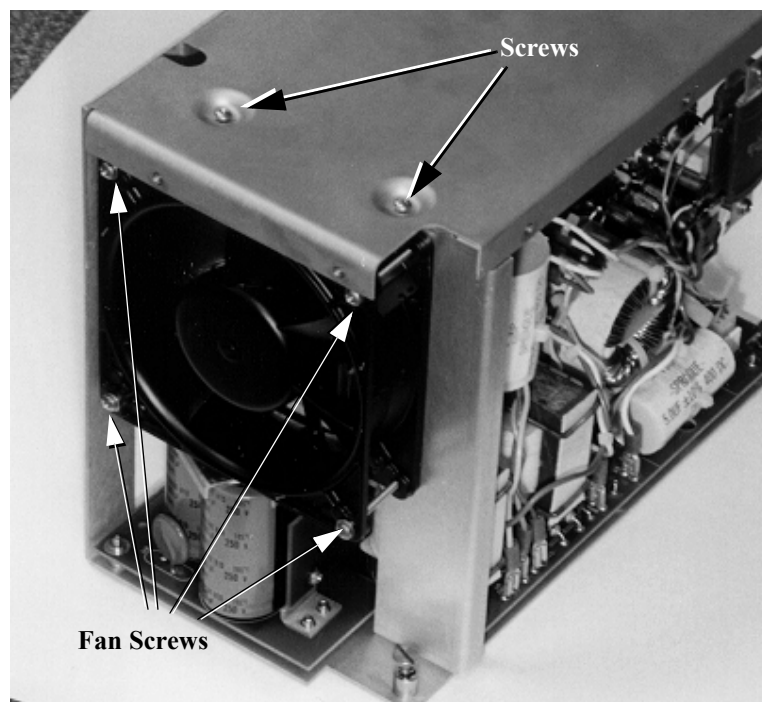


**Hot air exhausts from the fan outlet. Do not block it.**

## Replacing the Fan

The fan is part of the Amplifier Assembly, which is shown in Figure 4.23 on page 4-47. Take the following steps to replace it:

1. Remove the Amplifier Assembly from the instrument by following Steps 1-8 in "Replacing the Amplifier Assembly" on page 4-63.
2. Remove the Amplifier Assembly cover by removing the two screws that hold it in place (Figure 4.54) using a Phillips-head screwdriver. Then, lift the cover off.



*Figure 4.54 Amplifier Assembly Cover, Fan Screw Locations*

3. Remove four screws, with washers, at the corners of the fan (Figure 4.54).
4. Release two connectors at the top of the fan.
5. Cut the tie wrap holding the connectors in place using a pair of wire cutters.
6. Unpack the replacement fan and insert it into the Amplifier Assembly.
7. Connect the two connectors.
8. Replace the four screws and washers at the corners of the fan.



9. Replace the Amplifier Assembly back into the instrument by following Steps 10-19 in "Replacing the Amplifier Assembly" on page 4-63.

**NOTE**



**Hot air exhausts from the fan outlet. Do not block it.**



# Appendix A. M4000 Components Lists

## M4000 Insulation Analyzer

Components that may be included with the M4000 Insulation Analyzer are as follows:

No.	Number	Description	Qty
1	010-0097-01	Type M4200c Controller (optional)	1
2	010-0096-01	Type M4000 Instrument Case	1
3	02D-0024-02	Type M2 Cable, HV, 60 ft.	1
4	02C-5200-01	Liquid Insulation Cell (w/carrying case)	1
5	03D-1070-02	Transporter (optional)	1
6	02C-5798-09	Accessory Bag	1
7	2FB-2464-01	Documentation Bag	1

---

## Accessory Bag

No.	Number	Description	Qty
1	RC	Revision Level D	0 EA
2	181-0452	Power Cord, 6 ft. #14/3, Receptacle box to Instrument & Controller	2 EA
3	181-0499	Power Cord, 50 ft. #14/3	1 EA
4	181-0117	Cord, Adapter, 1EC320 to Nema5, Receptacle box to female plug (for laptop)	1 EA
5	05B-0430-01	P/A, Cable, Int-Con. (Intercase communication cable)	1 EA
6	02C-0019-01	Cable, Ground, 30 ft.	1 EA
7	02B-0050-07	Cable, Safety SW 8 ft.	1 EA
8	02B-0050-06	Cable, Safety SW 65 ft.	1 EA
9	02B-0020-02	Lead, LV, Blue 65 ft.	1 EA
10	02B-0020-03	Lead, LV, Red 65 ft.	1 EA
11	02B-0026-01	Lead, Ground 3 ft.	1 EA
12	02B-0026-02	Lead, Ground 5 ft.	5 EA
13	02B-0017-01	Red Jumper Cable, Insulated, LD	2 EA
14	02B-0089-01	P/ASY, Prong, Test (Type O bushing tap adapter)	1 EA
15	O20-0048-01	P/A, Collar, Cond. Set	1 Ea
16	02B-0012-01	P/ASY, Adapter, Bushing (Type S bushing tap adapter)	1 EA
17	2FC-4836-01	Hook, Cable, 9 inch diameter	1 EA
18	03B-1137-01	P/A, Adapter Bushing (ASEA bushing tap adapter)	1 EA
19	212-0416	Connector, Female, Undergrounding (O+ bushing tap adapter)	1 EA
20	2FB-2463-01	Bag, Cable, Grey	1 EA
21	09C-0613-01	RWK, Strobe Light (optional)	1 EA

---

<b>No.</b>	<b>Number</b>	<b>Description</b>	<b>Qty</b>
22	09C-0614-01	Temp. & Humid. Sensor (old) (optional)	1 EA
23	03C-1318-01	Temp. & Humid. Sensor (new) (optional)	1 EA
24	05B-0492-01	Cable, Strobe Light (optional)	1 EA
25	05B-0493-01	Cable, Temp./Humid Sensor (optional)	1 EA
26	03C-1074-01	P/A, Box, Power Receptacle.	1 EA
27	05B-0495-01	Diagnostic Test Cable, W51, Fld, Adapter	1 EA
28	181-0095	Power Cord, 10 ft. 18/3, Nemas/IEC 320	1 EA
29	05B-0508-01	Conn., Loopback, Plug	1 EA
30	05B-0509-01	Conn., Loopback, Rcpt	1 EA
31	05B-0503-01	PC to Instrument Cable	1 EA

---

## Documentation Bag

No.	Number	Description	Qty
1	RC	Revision Level C	0 EA
2	2FB-2464-01	Bag, Gray Document	1 EA
3	401-0051	Paper 8 3/4 x 100 ft. Thermal Bl	2 EA
4	903-0023	Paper Tube, 2 in x 9 1/2 in White	2 EA
5	401-0076	Software MS DOS 6 x 3.5 Fullman	1 EA
6	903-0026	Diskette Box M4000	1 EA
7	903-0026	Diskette Box DTA	1 EA
8	903-0026	Diskette Box User	1 EA
9	500-0100	Manual Oper M4K Insul. Analyzer	1 EA
10	903-0030	Drive, 5/64, 5 in Lg. Allen HD	1 EA
11	08A-0021-01	Disk Set, Software	1 EA
12	08A-0022-01	Disk, Util. & Root	1 EA
13	401-0121	Windows 3.1 Diskettes	
14		Patch Cable & Modem Manual	

# Appendix B. Warranty

## RENTAL EQUIPMENT

The Doble Service and Equipment Agreement provides perpetual hardware and software maintenance for the M4000 Insulation Analyzer throughout the agreement term.

## PURCHASED EQUIPMENT

### Limited Warranty

Doble Engineering Company (DOBLE) warrants the products that it manufactures to be free from defects in materials and workmanship for a period of one year from the date shipped from the factory.

During the one year warranty period, DOBLE will repair or replace, at its option, any defective products or components thereof at no additional charge, provided that the product or component is returned, shipping paid, to DOBLE. The purchaser is responsible for insuring any product or component so returned and assumes the risk of loss during shipment. All replaced products and components become the property of DOBLE.

THIS LIMITED WARRANTY DOES NOT EXTEND TO ANY PRODUCTS WHICH HAVE BEEN DAMAGED AS A RESULT OF ACCIDENT, MISUSE, ABUSE, OR AS A RESULT OF MODIFICATION BY ANYONE OTHER THAN DOBLE OR AN AUTHORIZED DOBLE REPRESENTATIVE.

EXCEPT AS EXPRESSLY SET FORTH ABOVE, NO OTHER WARRANTIES, EXPRESSED OR IMPLIED, ARE MADE WITH RESPECT TO THE PRODUCT INCLUDING, BUT NOT LIMITED TO, ANY IMPLIED WARRANTIES OF MERCHANTABILITY AND FITNESS FOR A PARTICULAR PURPOSE. DOBLE EXPRESSLY DISCLAIMS ALL WARRANTIES NOT STATED HEREIN. IN THE EVENT THE PRODUCT IS NOT FREE FROM DEFECTS AS WARRANTED ABOVE, THE PURCHASER'S SOLE REMEDY SHALL BE REPAIR OR REPLACEMENT AS PROVIDED ABOVE. UNDER NO CIRCUMSTANCES WILL DOBLE BE LIABLE TO THE PURCHASER OR

ANY USER FOR ANY DAMAGES, INCLUDING WITHOUT LIMITATION, PERSONAL INJURY OR PROPERTY DAMAGE CAUSED BY THE PRODUCT, ANY INCIDENTAL OR CONSEQUENTIAL DAMAGES, EXPENSES, LOST PROFITS, LOST SAVINGS, OR OTHER DAMAGES ARISING OUT OF THE USE OF OR INABILITY TO USE THIS PRODUCT.

## **Software Limited Warranty**

THIS SOFTWARE PRODUCT IS PROVIDED “AS IS” WITHOUT WARRANTY OF ANY KIND, EITHER EXPRESSED OR IMPLIED, INCLUDING, BUT NOT LIMITED TO THE IMPLIED WARRANTIES OF MERCHANTABILITY AND FITNESS FOR A PARTICULAR PURPOSE. THE ENTIRE RISK AS TO THE QUALITY AND PERFORMANCE OF THIS SOFTWARE PRODUCT IS WITH PURCHASER SHOULD THE PRODUCT PROVE DEFECTIVE. PURCHASER (AND NOT DOBLE OR AN AUTHORIZED DEALER) ASSUMES THE ENTIRE COST OF ALL NECESSARY SERVICING, REPAIR, OR CORRECTION.

SOME STATES DO NOT ALLOW THE EXCLUSION OF IMPLIED WARRANTIES SO THE ABOVE EXCLUSION MAY NOT APPLY. THIS WARRANTY GIVES THE PURCHASER SPECIFIC LEGAL RIGHTS AND THE USER MAY ALSO HAVE OTHER RIGHTS WHICH VARY FROM STATE TO STATE.

DOBLE warrants the disks on which the software product is furnished to be free from defects in materials and workmanship under normal use for a period of one hundred and twenty (120) days from the date of shipment from DOBLE.

## **Limitations of Remedies**

DOBLE's entire liability and Purchaser's exclusive remedy shall be:

1. The replacement of any disks not meeting DOBLE's “Limited Warranty” which are returned to DOBLE.
2. If DOBLE is unable to deliver replacement disks which are free from defects in materials and workmanship, Purchaser may terminate this agreement by returning the software product and all copies thereof in any form and affirming compliance with this requirement in writing. DOBLE will refund the purchase price.



IN NO EVENT WILL DOBLE BE LIABLE TO PURCHASER FOR ANY DAMAGES, INCLUDING ANY LOST PROFITS, LOST SAVINGS, OR OTHER INCIDENTAL OR CONSEQUENTIAL DAMAGES ARISING OUT OF THE USE OR INABILITY TO USE SUCH SOFTWARE PRODUCT EVEN IF DOBLE OR AN AUTHORIZED DEALER HAS BEEN ADVISED OF THE POSSIBILITY OF SUCH DAMAGES, OR FOR ANY CLAIM BY ANY OTHER PARTY.

SOME STATES DO NOT ALLOW THE LIMITATION OR EXCLUSION OF LIABILITY FOR INCIDENTAL OR CONSEQUENTIAL DAMAGES, SO THE ABOVE LIMITATION OR EXCLUSION MAY NOT APPLY.

**For Equipment Maintenance, Contact:**

**Contact your Doble Representative.**

Doble Engineering Company  
85 Walnut Street  
Post Office Box 9107  
Watertown, MA 02472-9107  
Tel: 617 393 2900  
Fax: 617 926 0528

For Equipment Maintenance, Contact:

---

# Appendix C. Error Messages

## M4100 Instrument Run Time Error Messages

This appendix lists the error messages displayed while using the M4000 Insulation Analyzer.

<b>Error #</b>	<b>Description of Error</b>
1	Invalid Message Number
2	Invalid Message Length
3	Unsupported Message
4	Test is Currently Running
5	Not Enough Free Space in FLASH for Application
6	Unused
7	FLASH Did Not Program Properly
8	FLASH Did Not Erase Properly
9	Invalid Number of Application Bytes Received
10	FLASH Execute Checksum Error
11	Boot Block Checksum Test Failed
12	Static RAM Test Failed
13	UART Internal Loopback Test Failed
14 - 19	Reserved for Future Use
20	Watchdog Reset Error
21	Invalid Message Parameter
22	Unused
23	Safety Switch 1 Open
24	Safety Switch 2 Open
25	Unused
26	Calibration Reference Overvoltage
27	Unused
28	Earth Ground Open
29	Safety Circuit DC Supply Low
30	Unused

---

<b>Error #</b>	<b>Description of Error</b>
31	Unused
32	Internal Amp Cable Disconnected
33	One or Both Safety Switch Cables Disconnected
34	Power Amp Power Bad
35	Overcurrent on Power Amp Output
36	Power Amp DC Supply High
37	Power Amp DC Supply Low
38	M4000 Synchronization Error
39	Phase Lock Loop Not Locked
40	Strobe Cable Not Plugged In
41	Strobe Not Flashing
42 - 49	Reserved for Future Use
50	Lead Changed During Test
51	Safety Switches Not Released Between Tests
52	Software Buffer Overrun
53	One or Both Low Voltage Leads Disconnected
54	Overcurrent Occurred
55	Amplifier OverTemperature Occurred
56	Input Current Peak Maximum Exceeded
57	Transformer OverTemperature Occurred
58	Test Stopped By Controller
59	Comm. Timeout Detected By Instrument
60	Main Reference OverTemperature Occurred
61	Calibration Reference OverTemperature Occurred
62	High Voltage Over 12.5 kV
63	Voltage Input Saturated
64	Requested Maximum Voltage Exceeded

## **M4000 Firmware/Application Errors**

<b>Error #</b>	<b>Description Of Error</b>
81	Unable to open application file

<b>Error #</b>	<b>Description Of Error</b>
82	Application file is corrupted
83	Error downloading application
84	Error programming FLASH ROM. application not found in FLASH.
85	M4100 FLASH ROM has been corrupted Unable to open M4100 Firmware file. Tests cannot be run M4100 Firmware file is corrupted. Tests cannot be run Error downloading M4100 Firmware. Tests cannot be run Error programming FLASH ROM. M4100 Firmware not found in FLASH. Tests cannot be run M4100 FLASH ROM has been corrupted. tests cannot be run M4100 Firmware file requires an updated version. Tests cannot be run

## M4000 Communications Errors

<b>Error #</b>	<b>Description of Error</b>
100	No Errors
101	Undefined Error
102	Requested Port Out Of Range
103	Port Already Set Up
104	Invalid Buffer Size Requested
105	No Memory For Buffers
106	Communications Not Initialized
107	Invalid Parameter
108	Buffer Is Empty
109	Buffer Is Full
110	Timed Out
111	Cts Inactive
112	Cd Inactive
113	Dsr Inactive

---

<b>Error #</b>	<b>Description of Error</b>
114	Error Accessing Comm. Port
115	Xmodem Exception
116	User Keyboard Abort
117	File I/O Error
118	Xmodem Protocol Error
119	Widetrack Rx Not On
120	Shared-Interrupt Parameter Wrong
121	Crc Mode Error
122	Modem Didn't Send Ok
123	No Modem Response
124	Function Not Supported
125	Illegal Baud Rate
126	Illegal Parity
127	Illegal Word Length
128	Illegal Number Of Stop Bits
129	Missing Copyright Notice
130	Driver Not Installed
131	User Buffer Overflow
132	Failure To Connect To Port
133	No Response From M4000, Check Connections
134	Communications Parity Error, Check Connections
135	Communications Overrun Error, Check Connections
136	Communications Framing Error, Check Connections
137	Invalid Message Number
138	Invalid Message Checksum
139	Invalid Message Length
140	Invalid Message ACK/NAK Byte
141	Received Loopback Message Does Not Match Transmitted Message
142	No Loopback Message Received
151	Error reading EEPROM data
152	Error writing EEPROM data
153	Board name not specified

<b>Error #</b>	<b>Description of Error</b>
154	Board slot not found
195	Illegal stop bits
196	Illegal word length
197	Illegal parity setting
198	Timed out
199	Function not supported
295	Handshake Line in use
296	Port Settings failed
297	Windows OS error
298	COM Port not found
299	COM Port in use





# Appendix D. Part Numbers

Doble part numbers of replaceable M4100 components are provided in this appendix.

<b>Description</b>	<b>Part Number</b>
Front Panel Assembly	03D-1056
Guard Front Panel Board	04D-0536
Amplifier Assembly	03D-1055-01
Guard Mode Switch Board	04D-0551
Timing Board	04D-0533
DSP/CPU Board	04D-0520
Safety Board	04D-0544
Main Reference Assembly	04D-0583
Guard Board	04D-0527
Low Voltage Power Supply Board	384-0138
Combined Assembly (LVPS & H/TC)	03D-1057-01
Heater/Temperature Controller Board	04D-0547
Field Calibration Reference	04D-0524
I/O Protection Board	04D-0546
Transformer	03D-1054
HV Pothead	03C-0056-07
Fan	380-0042



**A**

Advanced Configuration 2-19

**C**

Calibration Verification 4-26

Calver.log file 4-29

Clipboard

configuration 2-14

test mode 2-9

Test results 3-8

COM Port settings 2-5

Communications Loopback test 4-40

Configuration

Advanced 2-19

Clipboard 2-14

DTA 2-16

Instrument 2-18

System 2-13

**D**

Diagnostics 4-21

Disconnecting Leads 1-26

Display mode 2-15

Doble ship to address 1-18

Downloading firmware 2-1

DTA

Configuration 2-16

Test mode 3-17

**E**

Earth Ground Open 4-16

Electrostatic Interference 1-1

Error messages 4-16

External

Keyboard 1-6

Monitor 1-5

Mouse 1-6

External Reference test 3-12

**F**

Field Calibration Reference 1-7, 4-31, 4-82

Field Recalibration 4-31

Fieldcal.log file 4-34

Fuses 4-52

**G**

Grounding 1-21, 1-23

**H**

Help files 2-21

**I**

Induced Voltage 1-22

Insert a test line 2-12

Instrument configuration 2-18

Interference 1-1

**K**

Keyboard, External 1-6

**L**

Languages 2-20

Laptop Use 1-16

Leakage Reactance

Interface 1-9

Test 3-16

Line Frequency Modulation 2-14

Line Sync Reversal 1-2, 2-15

Log Files

Calver.log 4-29

Fieldcal.log 4-34

Loss Factor 2-16

**M**

M4000

Data directory 2-14

main screen 2-7

M4100

Component list 4-38

Error messages 4-16

Internal access 4-46

Weight 1-24

M4110 Leakage Reactance Interface 1-9

M4300 Transport 1-10

Main Screen 2-7

Monitor, external 1-5

Moving mode 1-11

**P**

PC

Connector Cable 1-16

Requirements 1-16

Printer setup 2-22

**R**

Ramp mode 2-14

Recalibration 4-31

Reference to 10 kV 2-15

Remove an empty test line 2-12

Resonator tests 3-25

RIV test 3-28

**S**

Safety 1-1, 1-19

Safety strobe 1-3, 1-24, 2-19

Serial to USB Converter 1-16

Settling time 2-19

Ship to address 1-18

Software Installation 2-1

Storage mode 1-11

Subsystem Diagnostics 4-34

System

Configuration 2-13

Status 4-23

**T**

Temperature Correction 2-12

Test

Clipboard mode 3-1

Conditions 3-3

DTA 3-17

External reference 3-12

Leakage Reactance 3-16

Mode, M4000 1-13

Options 2-16

Resonator 3-25

RIV 3-28

Type 2-15

Thermal profile 4-39

Time/Date format 2-6

Trapped Charges 1-22

Troubleshooting

Common user errors 4-1

Guide 4-2

HV Cable 4-42

Liquid Insulation Cell 4-43

LV leads 4-42

M4100 Diagnostics 4-21

M4100 Instrument 4-5

M4100 or M4200c? 4-3

PC COM port 2-5

PC Comport Setting 1-16

**U**

USB to Serial Converter 1-16